

Lecture 9

Chemical Reaction Engineering (CRE) is the field that studies the rates and mechanisms of chemical reactions and the design of the reactors in which they take place.

Lecture 9 – Thursday 2/7/2013

Balances in terms of molar flow rates

- Block 1: **Mole Balances**
Balance Equation on Every Species
- Block 2: **Rate Laws**
Relative Rates
Transport Laws
- Block 3: **Stoichiometry**
- Block 4: **Combine**

- **Membrane Reactors:**
Used for thermodynamically limited reactions

Review Lecture 1

Reactor Mole Balances Summary

The GMBE applied to the four major reactor types
(and the general reaction $A \rightarrow B$)

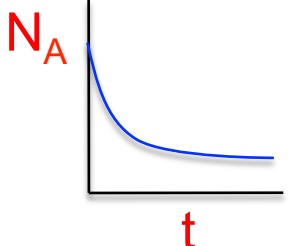
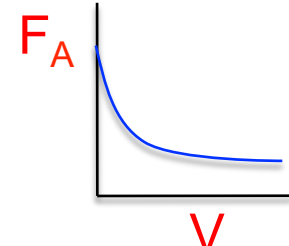
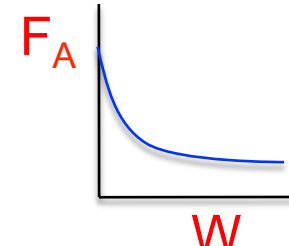
Reactor	Differential	Algebraic	Integral	
Batch	$\frac{dN_A}{dt} = r_A V$		$t = \int_{N_{A0}}^{N_A} \frac{dN_A}{r_A V}$	
CSTR		$V = \frac{F_{A0} - F_A}{-r_A}$		
PFR	$\frac{dF_A}{dV} = r_A$		$V = \int_{F_{A0}}^{F_A} \frac{dF_A}{r_A}$	
PBR	$\frac{dF_A}{dW} = r'_A$		$W = \int_{F_{A0}}^{F_A} \frac{dF_A}{r'_A}$	

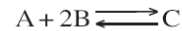

Mole Balance

① Write mole balance on each species.†

$$\text{e.g., } \frac{dF_A}{dV} = r_A, \quad \frac{dF_B}{dV} = r_B, \quad \frac{dF_C}{dV} = r_C$$

Rate Law

② Write rate law in terms of concentration.

$$\text{e.g., } -r_A = k_A \left(C_A C_B^2 - \frac{C_C}{K_C} \right)$$

Relative Rates

③ Relate the rates of reaction of each species to one another.

$$\frac{-r_A}{1} = \frac{-r_B}{2} = \frac{r_C}{1}$$

$$\text{e.g., } r_B = 2r_A, \quad r_C = -r_A$$

Stoichiometry

④ (a) Write the concentrations in terms of molar flow rates for isothermal *gas-phase* reactions.

$$\text{e.g., } C_A = C_{T0} \frac{F_A}{F_T} \frac{P}{P_0}, \quad C_B = C_{T0} \frac{F_B}{F_T} \frac{P}{P_0}$$

$$\text{with } F_T = F_A + F_B + F_C$$

(b) For *liquid-phase* reactions, use concentration, e.g., C_A, C_B

Pressure Drop

⑤ Write the *gas-phase* pressure drop term in terms of molar flow rates.

$$\frac{dp}{dW} = -\frac{\alpha}{2p} \frac{F_T}{F_{T0}} \quad \text{with } p = \frac{P}{P_0}$$

Combine

⑥ Use an ODE solver or a nonlinear equation solver (e.g., Polymath) to combine Steps ① through ⑤ to solve for, for example, the profiles of molar flow rates, concentration, and pressure.

† For PBR, use $\frac{dF_A}{dW} = r_A, \quad \frac{dF_B}{dW} = r_B, \quad \frac{dF_C}{dW} = r_C$.

Membrane Reactors

Membrane reactors can be used to achieve conversions greater than the original equilibrium value. These higher conversions are the result of ***Le Chatelier's principle***; you can remove the reaction products and drive the reaction to the right.

To accomplish this, a membrane that is permeable to that reaction product, but impermeable to all other species, is placed around the reacting mixture.

Membrane Reactors

Dehydrogenation Reaction:

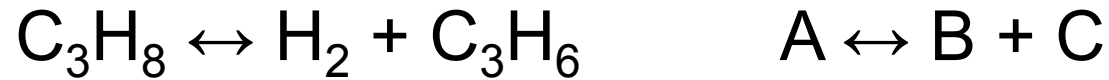

Thermodynamically Limited:

exothermic

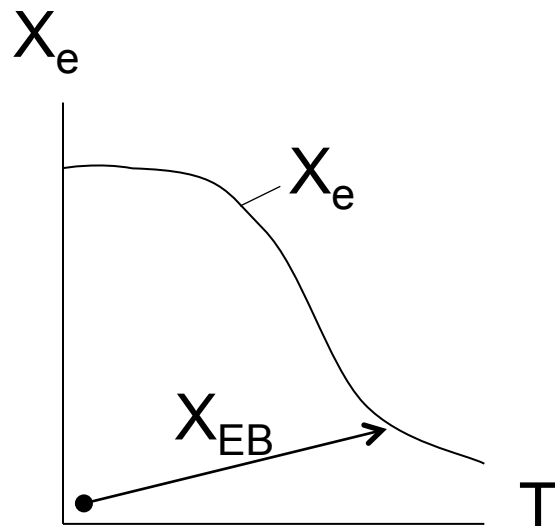

Membrane Reactors

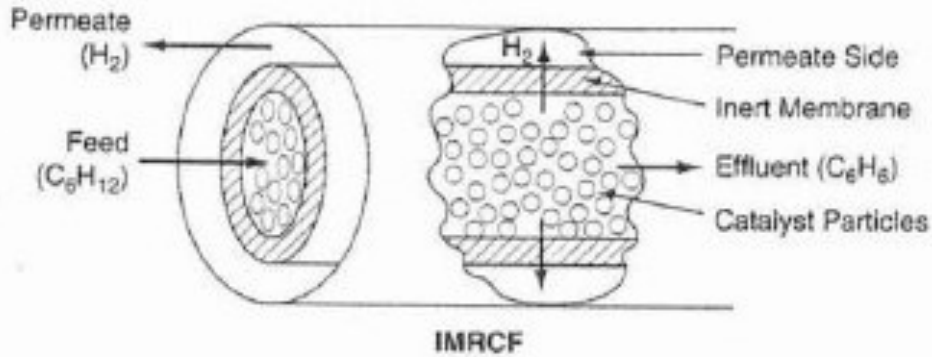

Cross section of IMRCF

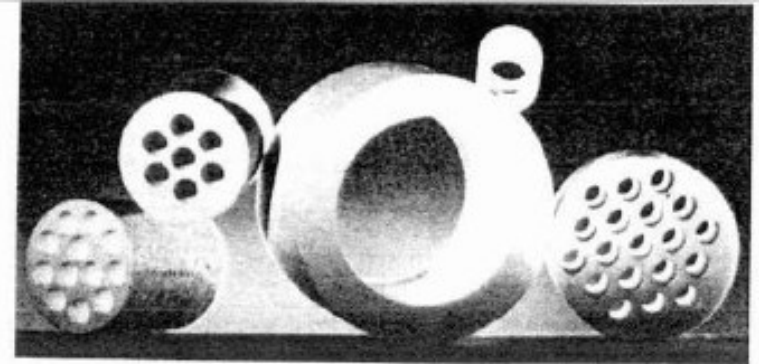

Membrane Reactors

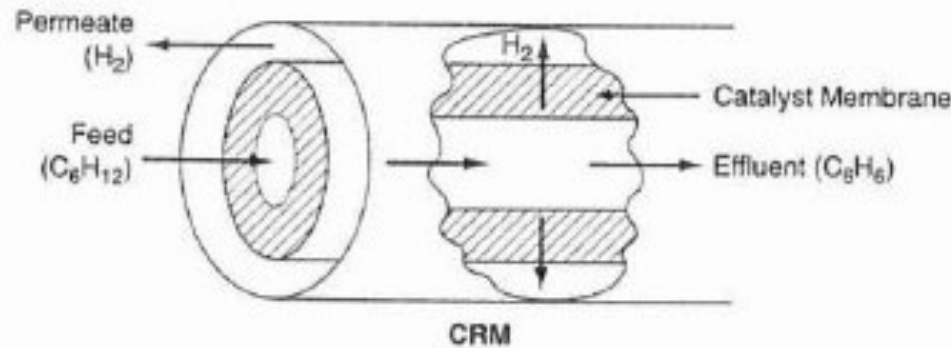

Cross section of CRM

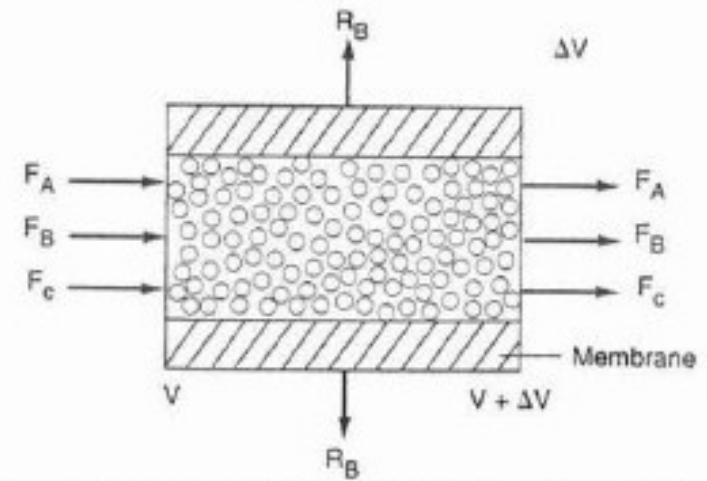

Schematic of IMRCF for mole balance

Membrane Reactors

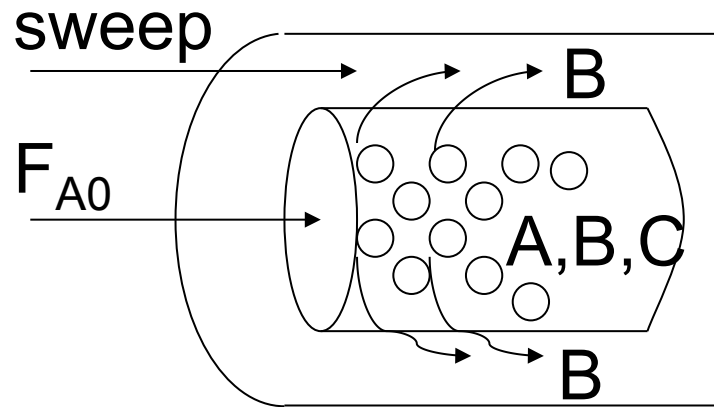

$$W = \rho_b V = \text{solids weight}$$

$$\rho_b = (1-\phi)\rho_C = \text{bulk solids density}$$

$$\rho_C = \text{density of solids}$$

$$\phi = \text{volume solids/volume total} * \text{mass of solids/volume solids}$$

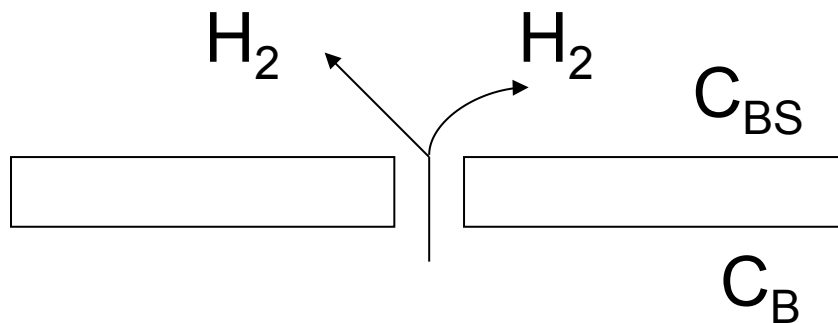

A, C stay behind since they are too big

Membrane Reactors

Mole Balance on Species A:

Species A: In – out + generation = 0

$$F_A|_V - F_A|_{V+\Delta V} + r_A \Delta V = 0$$

$$\frac{dF_A}{dV} = r_A$$

Membrane Reactors

Mole Balance on Species B:

Species B: In – out – out membrane + generation = 0

$$F_B|_V - F_B|_{V+\Delta V} - R_B\Delta V + r_B\Delta V = 0$$

$$\frac{dF_B}{dV} = (r_B - R_B)$$

$$R_B = \frac{\text{moles of B through sides}}{\text{volume of reactor}}$$

Membrane Reactors

$$W_B = k'_C (C_B - C_{BS}) = \frac{\text{molar flow rate through membrane}}{\text{surface area of membrane}} \left[\frac{\text{mol}}{\text{m}^2 \cdot \text{s}} \right]$$

$$a = \frac{\text{membrane surface area}}{\text{reactor volume}} = \frac{\pi D L}{\frac{\pi D^2}{4} L} = \frac{4}{D} \left[\frac{\text{m}^2}{\text{m}^3} \right]$$

$$R_B = W_B a = k'_C a [C_B - C_{BS}]$$

$$k_C = k'_C a$$

$$R_B = k_C [C_B - C_{BS}] \left[\frac{\text{mol}}{\text{m}^3 \cdot \text{s}} \right]$$

↑
Neglected most of the time

Membrane Reactors

Mole Balances:

$$(1) \quad \frac{dF_A}{dV} = r_A$$

$$(2) \quad \frac{dF_B}{dV} = r_B - R_B$$

$$(3) \quad \frac{dF_C}{dV} = r_C$$

Rate Law:

$$(4) \quad r_A = -k \left[C_A - \frac{C_B C_C}{K_C} \right]$$

Membrane Reactors

Relative Rates: $\frac{-r_A}{1} = \frac{r_B}{1} = \frac{r_C}{1}$

Net Rates: (5) $r_A = -r_B, \quad r_A = -r_C$

Transport Law: (6) $R_B = k_C C_B$

Stoichiometry: (7) $C_A = C_{T0} \frac{F_A}{F_T}$ (isothermal, isobaric)

(8) $C_B = C_{T0} \frac{F_B}{F_T}$

(9) $C_C = C_{T0} \frac{F_C}{F_T}$

(10) $F_T = F_A + F_B + F_C$

Parameters: $C_{T0} = 0.2, \quad F_{A0} = 5, \quad k = 4, \quad K_C = 0.0004, \quad k_C = 8$

Membrane Reactors

Example: The following reaction is to be carried out isothermally in a **membrane reactor** with no pressure drop. The membrane is permeable to product C, but impermeable to all other species.

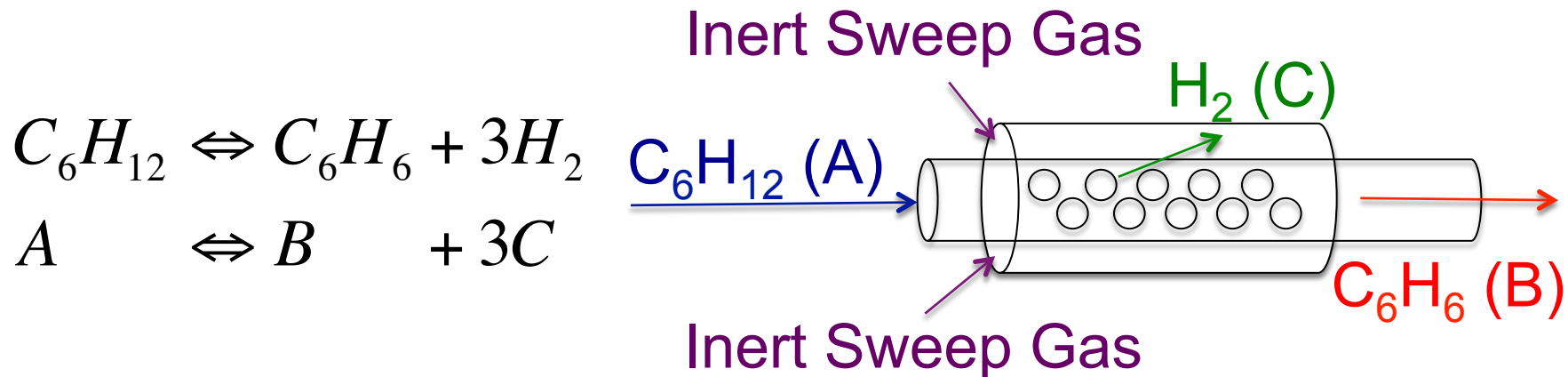

For **membrane reactors**, we cannot use conversion. We have to work in terms of the molar flow rates F_A , F_B , F_C .

Membrane Reactors

Mole Balances



$$\frac{dF_A}{dW} = r_A'$$

$$\frac{dF_B}{dW} = r_B'$$

$$\frac{dF_C}{dW} = r_C' - k_c C_C$$

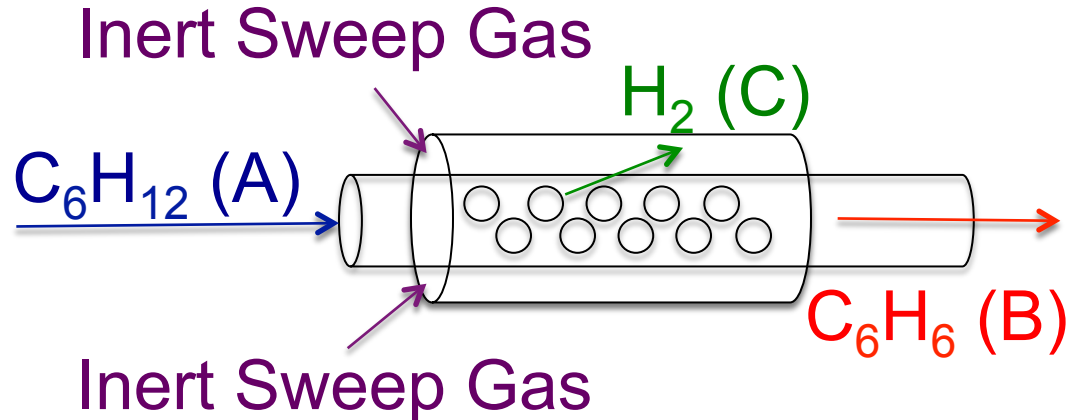

Membrane Reactors

Rate Law:
$$-r_A' = k_A \left[C_A - \frac{C_B C_C^3}{K_C} \right]$$

Relative Rates:
$$\frac{r_A'}{-1} = \frac{r_B'}{1} = \frac{r_C'}{3}$$

Net Rates:

$$r_B' = -r_A'$$
$$r_C' = -3r_A'$$

Membrane Reactors

Stoichiometry:

Isothermal, no Pressure Drop

$$C_{T0} = \frac{P_0}{RT_0}$$

$$C_A = C_{T0} \frac{F_A}{F_T}$$

$$C_B = C_{T0} \frac{F_B}{F_T}$$

$$C_C = C_{T0} \frac{F_C}{F_T}$$

$$F_T = F_A + F_B + F_C$$

Membrane Reactors

Combine: - Use Polymath

Parameters:

$$C_{T0} = 0.2 \frac{\text{mol}}{\text{dm}^3}$$
$$F_{A0} = 10 \frac{\text{mol}}{\text{s}}$$
$$k_A = 10 \frac{\text{dm}^3}{\text{kg cat s}}$$
$$k_C = 0.5 \frac{\text{dm}^3}{\text{kg cat s}}$$
$$K_C = 200 \frac{\text{mol}^2}{\text{dm}^6}$$

Membrane Reactors

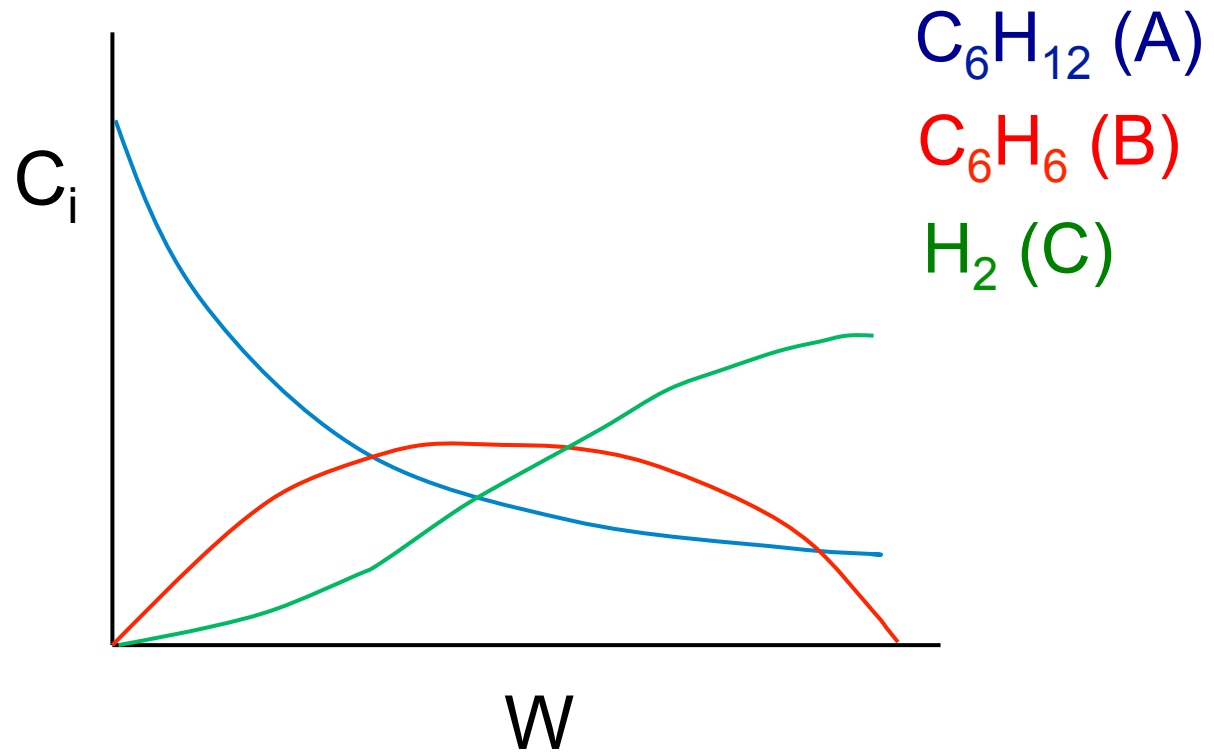

End of Lecture 9