

Dark Energy and the Accelerating Universe

Dragan Huterer

Physics Department
University of Michigan

Makeup of universe **today**

Visible Matter
(stars 0.4%, gas 3.6%)

Dark Energy
(suspected since 1980s
established since 1998)

Dark Matter
(suspected since 1930s
established since 1970s)

Also:
radiation (0.01%)

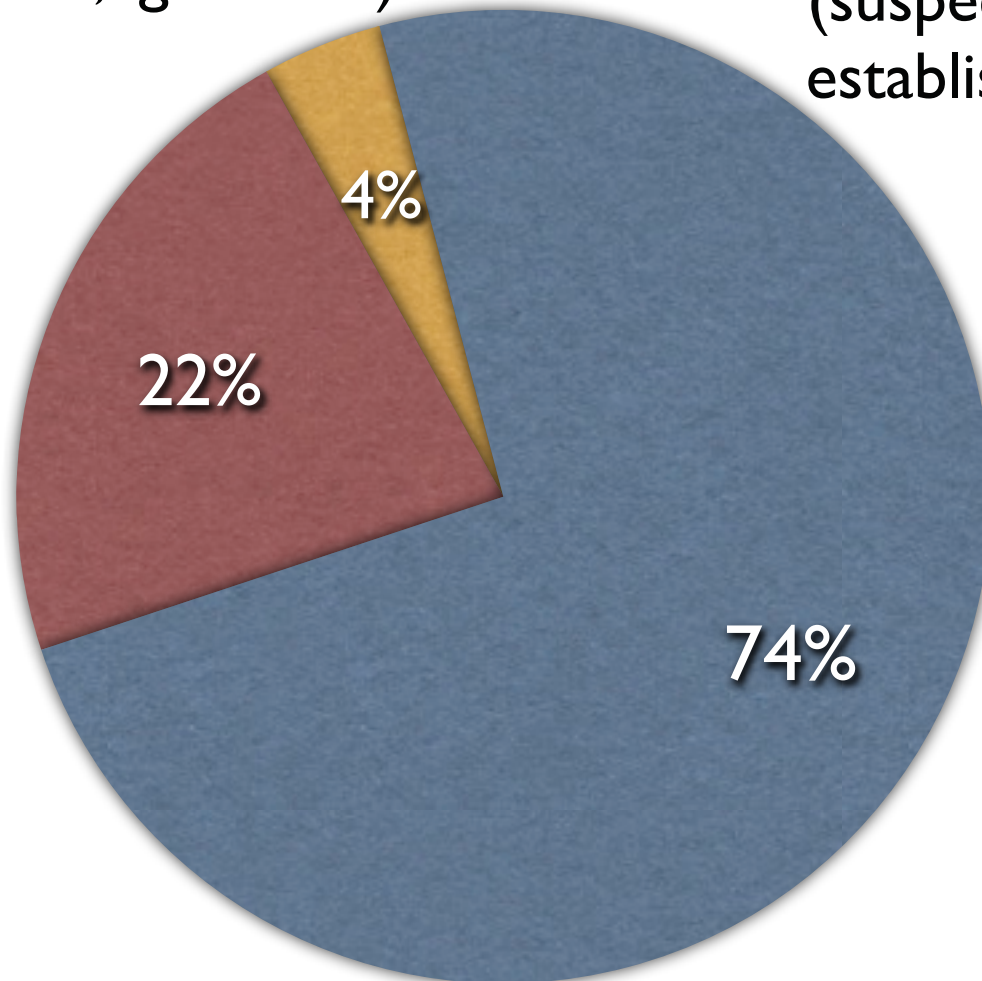

Some of the early history of the Universe is actually understood better!

Physics quite well understood

95% of contents only phenomenologically described

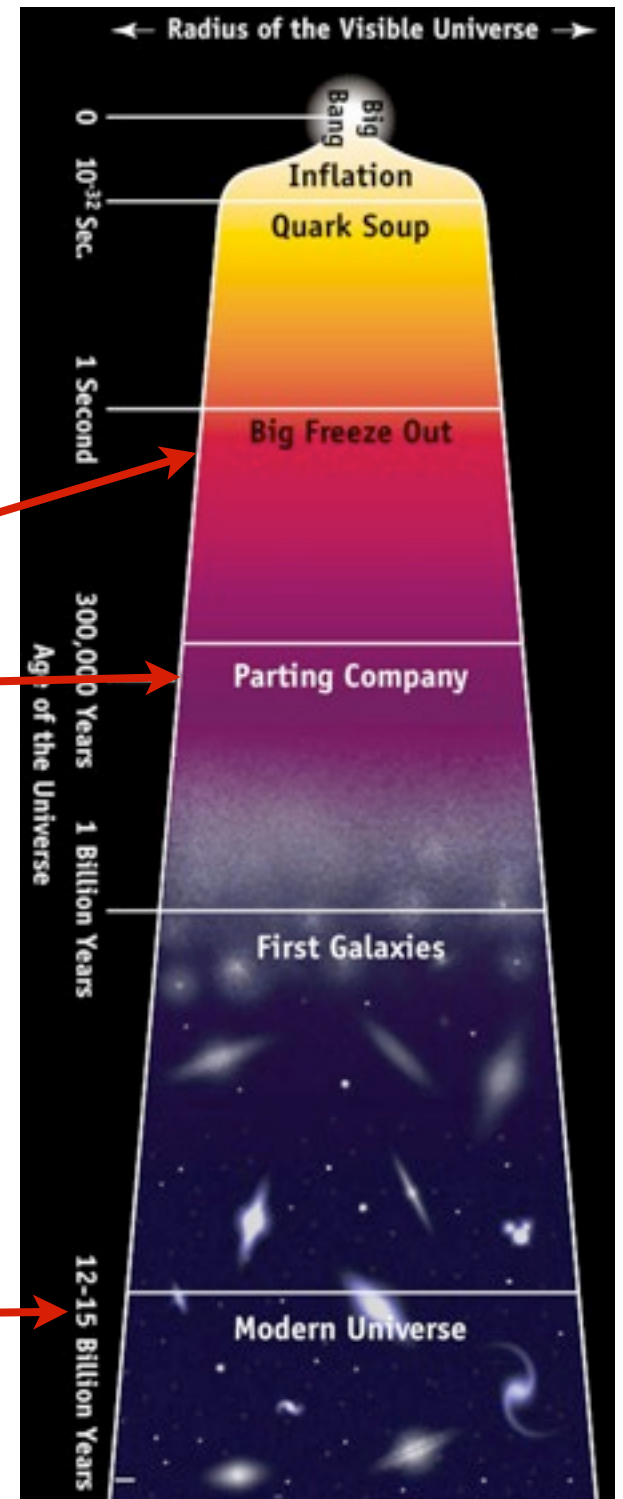

Friedmann Equation

$$H^2 = \frac{8\pi G}{3}\rho - \frac{\kappa}{a^2}$$

$$\text{define } \Omega \equiv \rho \frac{8\pi G}{3H^2} \equiv \frac{\rho}{\rho_{\text{crit}}}$$

Inflation predicts, and
CMB anisotropy indicates

universe is flat (curvature is zero), so $\Omega_{\text{TOT}} = 1$ (or $\kappa = 0$)

Galaxy distribution indicates matter makes up 25% of critical density, so $\Omega_{\text{M}} \approx 0.25$

So where is 75% of the energy density?

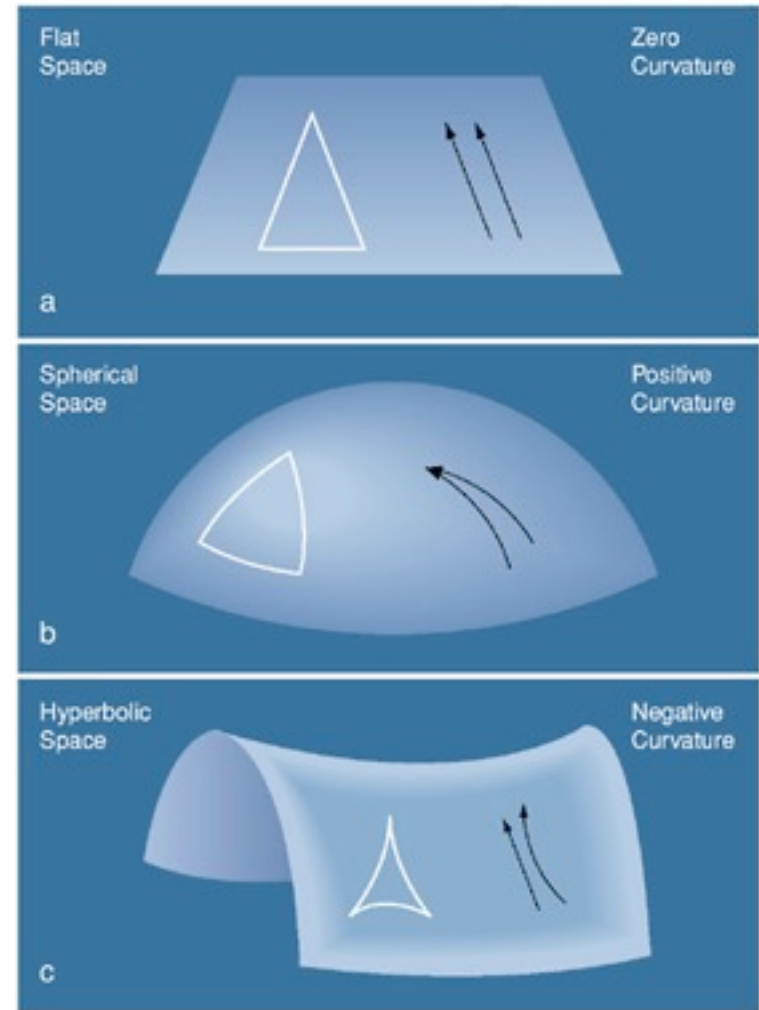

Type Ia Supernovae

A white dwarf accretes matter from a companion.

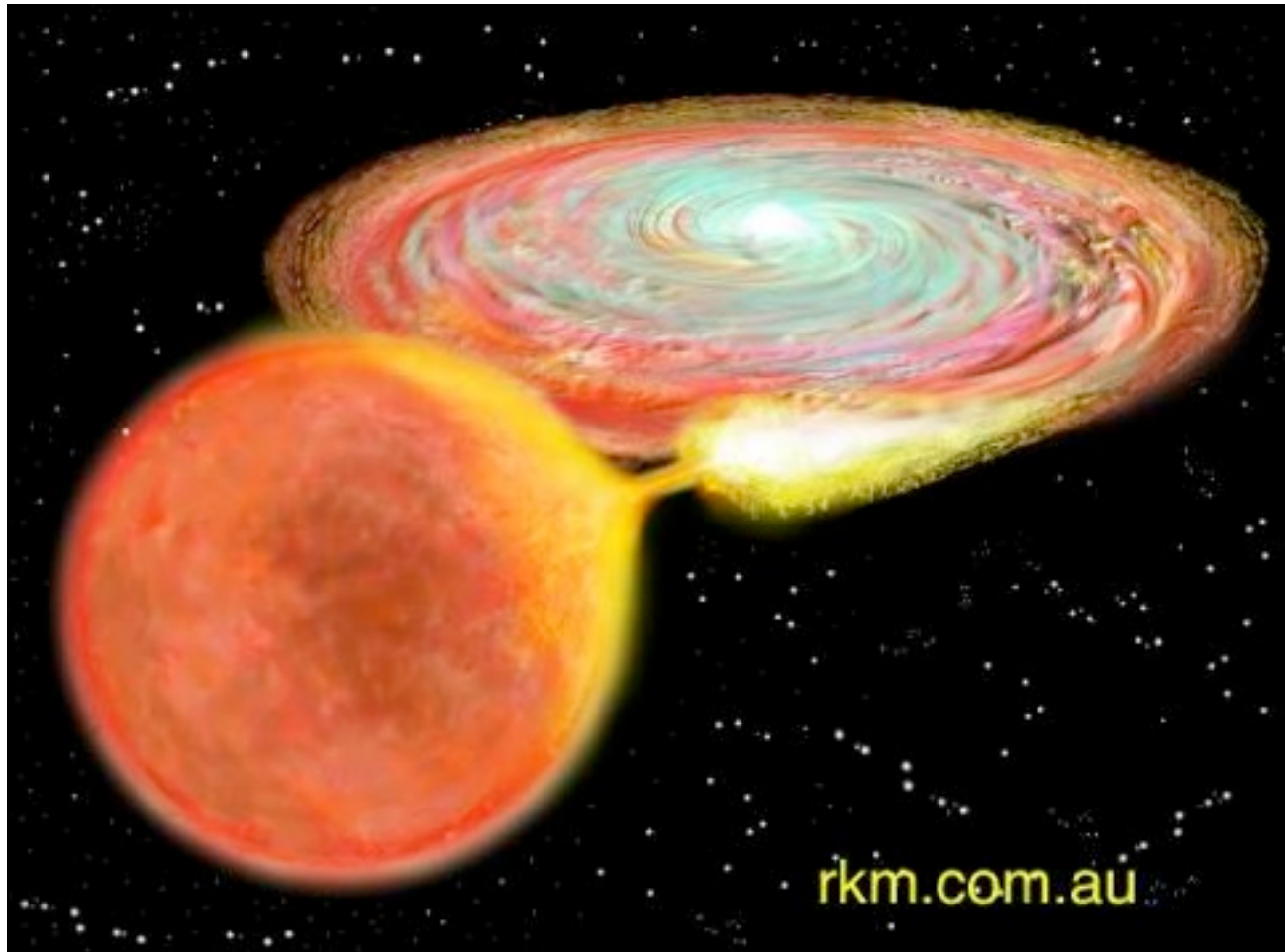

ensive investigations of extragalactic
brought to light the remarkable fact
types of new stars or novae which might
e and *super-novae*. No intermediate

rather frequent phenomenon in certain
to Bailey,¹ ten to twenty novae flash up

A similar frequency (30 per year) has
-known Andromeda nebula. A char-
n novae is their absolute brightness
n is -5.8 with a range of perhaps 3 to 4
to 20,000 times the radiation of the sun.
on novae therefore belong to the abso-
tems. This is in full agreement with
to discover this type of novae in other
to reach stars of absolute magnitude
ent

of the second group (*super-novae*) pre-
uzzle because this type of new star was
s, but apparently all over the accessible

SNe Ia are “Standard Candles”



If you know the intrinsic brightness of the headlights, you can estimate how far away the car is

(car headlights example)

A way to measure (relative) distances to objects far away

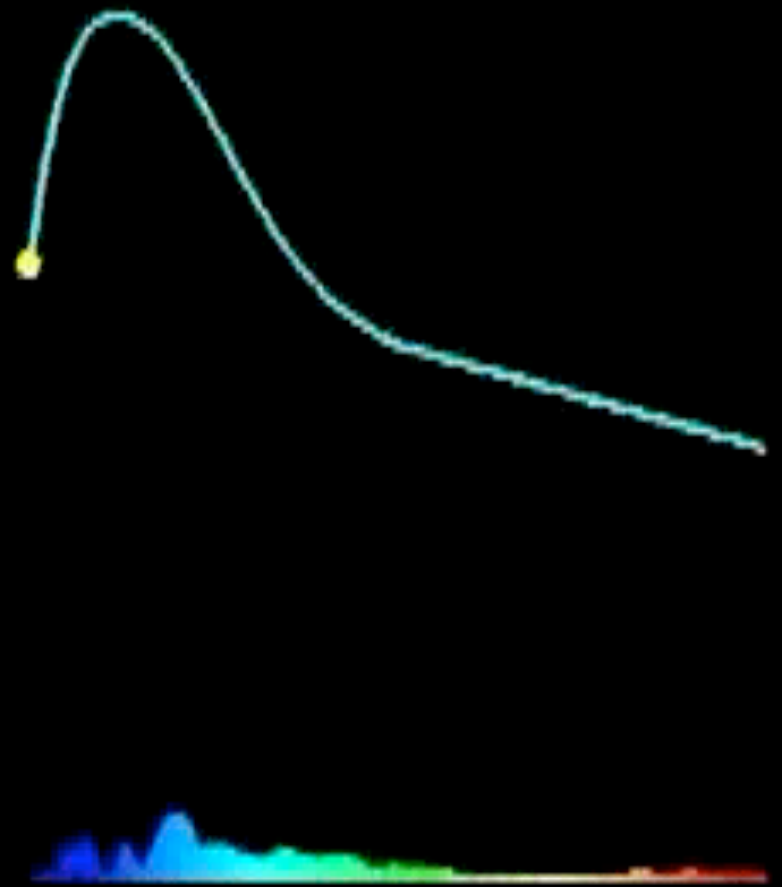

credit: Supernova Cosmology Project

Standardizing the candles

Abstract. Absolute magnitudes in the B , V , and I bands are derived for nine well-observed Type Ia supernovae using distances estimated via the surface brightness fluctuations or Tully-Fisher methods. These data show a significant intrinsic dispersion in the absolute magnitudes at maximum light of Type Ia supernovae amounting to ± 0.8 mag in B , ± 0.6 mag in V , and ± 0.5 mag in I . Moreover, the absolute magnitude is tightly correlated with the initial rate of decline of the B light curve, with the slope of the correlation being steepest in B and becoming progressively flatter in the V and I bands. This implies that the light curves of Type Ia supernovae at maximum light are not identical, with the fastest declining events corresponding to the intrinsically reddest events. Certain spectroscopic properties may also be correlated with the initial decline rate. These results are most simply interpreted as evidence for a range of explosion mechanisms, although variations in the explosion mechanism are also possible. Considerable care must be taken in employing Type Ia supernovae as cosmological standard candles, particularly at large redshifts where selection bias could be an important effect.

Subject headings: distance scale — supernovae: general

Standardizing the candles

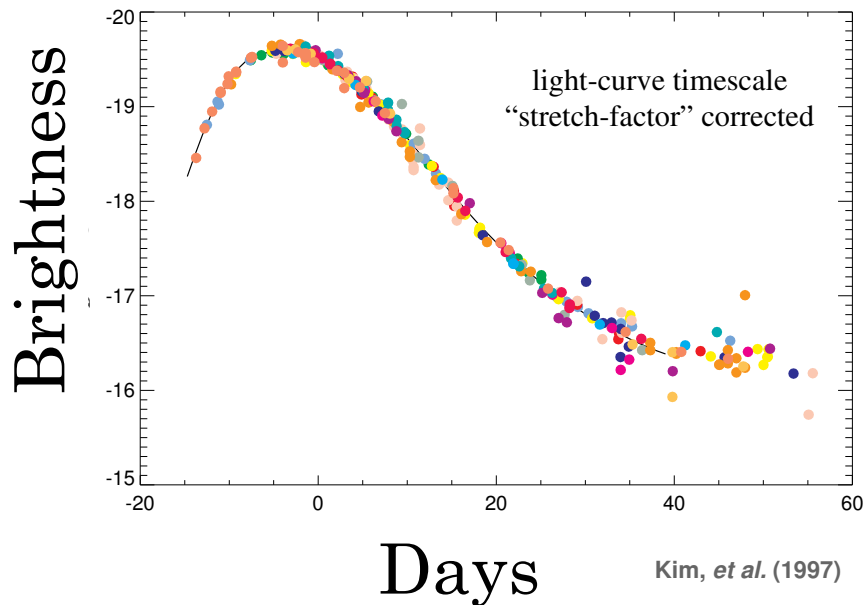
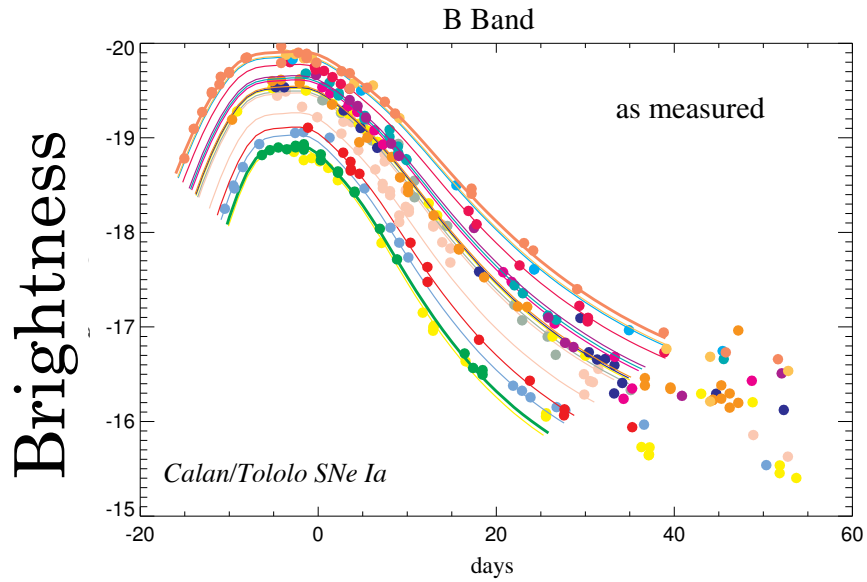

“Broader
is
Brighter”

But how do you find SNe?

Rate: 1 SN per galaxy per 500 yrs!

Solution:

1. use world's large telescopes,
2. schedule them to find, then “follow-up” SNe
3. put in heroic hard work

Saul Perlmutter,
Supernova Cosmology Project



Brian Schmidt,
High-redshift Supernova Team



Supernova Hubble diagram

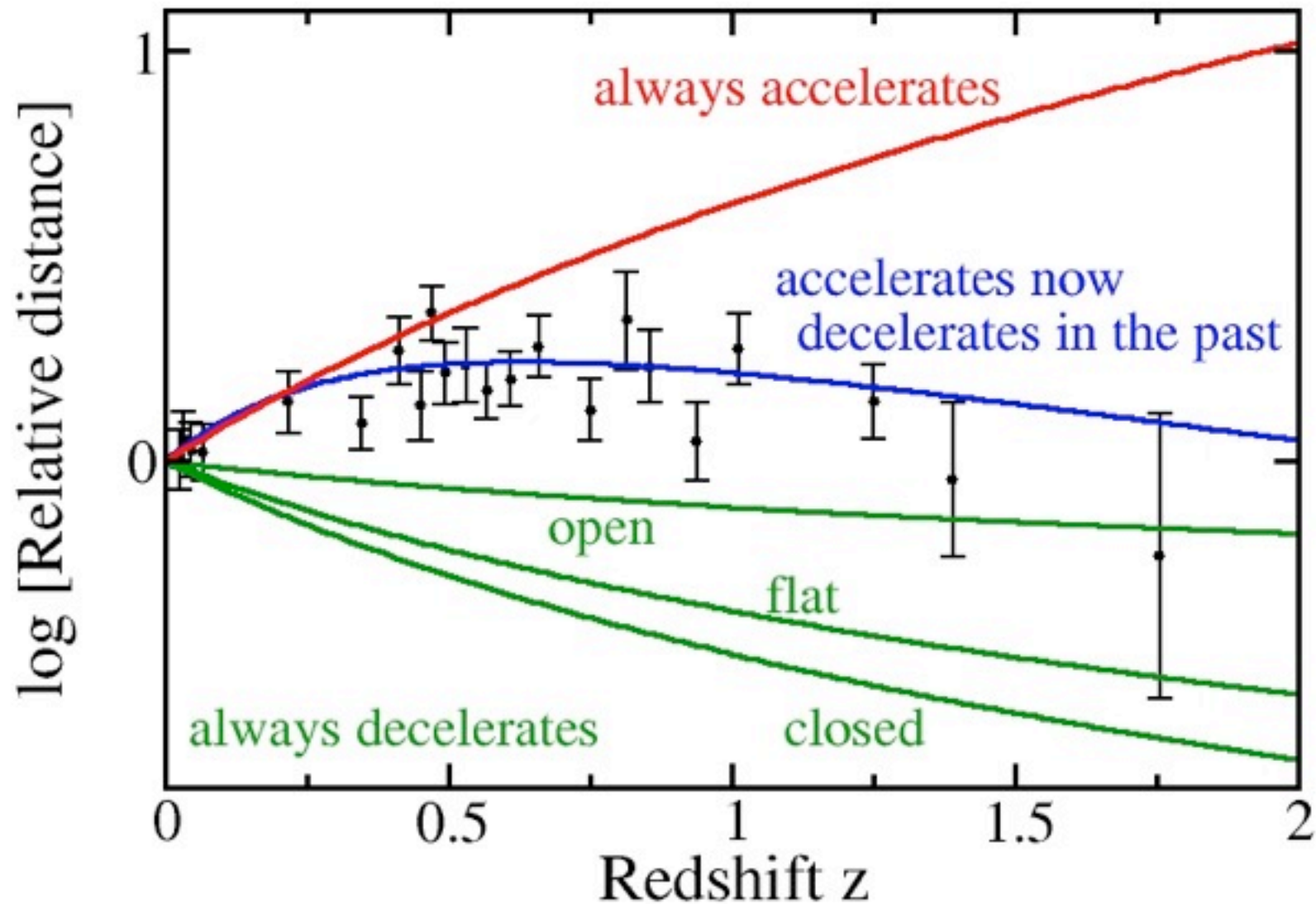

Dark Energy Parametrization

Distant SNe are **dimmer** than expected \Rightarrow
the expansion of the universe is **accelerating**

$$\frac{\ddot{a}}{a} = -\frac{4\pi G}{3}(\rho + 3p)$$

so, pressure of dark energy is strongly **negative**

Equation of state ratio: $w = \frac{p_{\text{DE}}}{\rho_{\text{DE}}}$

Energy density today (relative to critical): $\Omega_{\text{DE}} = \frac{\rho_{\text{DE}}}{\rho_{\text{crit}}}$

For vacuum energy $w = -1$ ($G_{\mu\nu} + \Lambda g_{\mu\nu} = 8\pi G T_{\mu\nu}$)

Current (2008) constraints

Supernova Cosmology Project
Kowalski, et al., *Ap.J.* (2008)

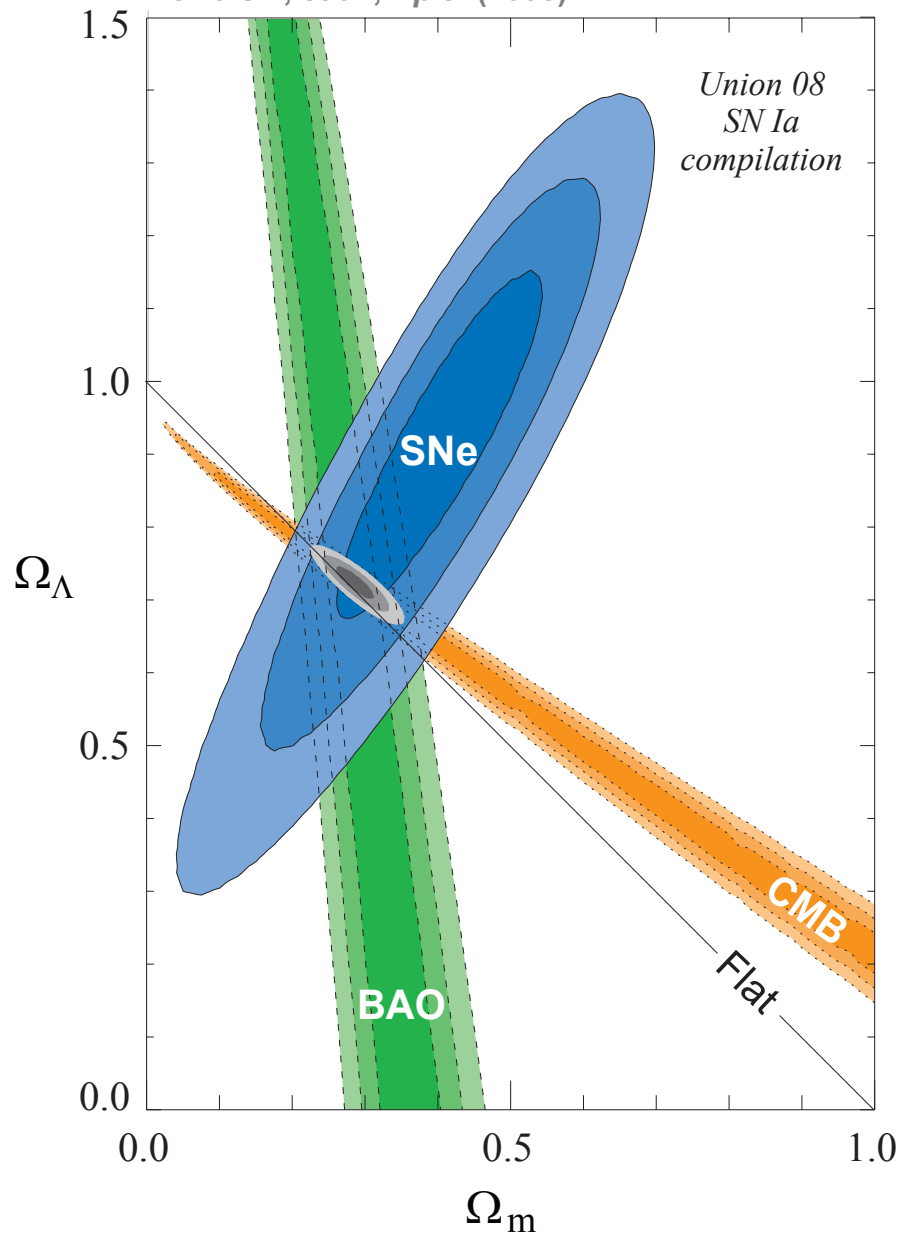

Supernova Cosmology Project
Kowalski, et al., *Ap.J.* (2008)

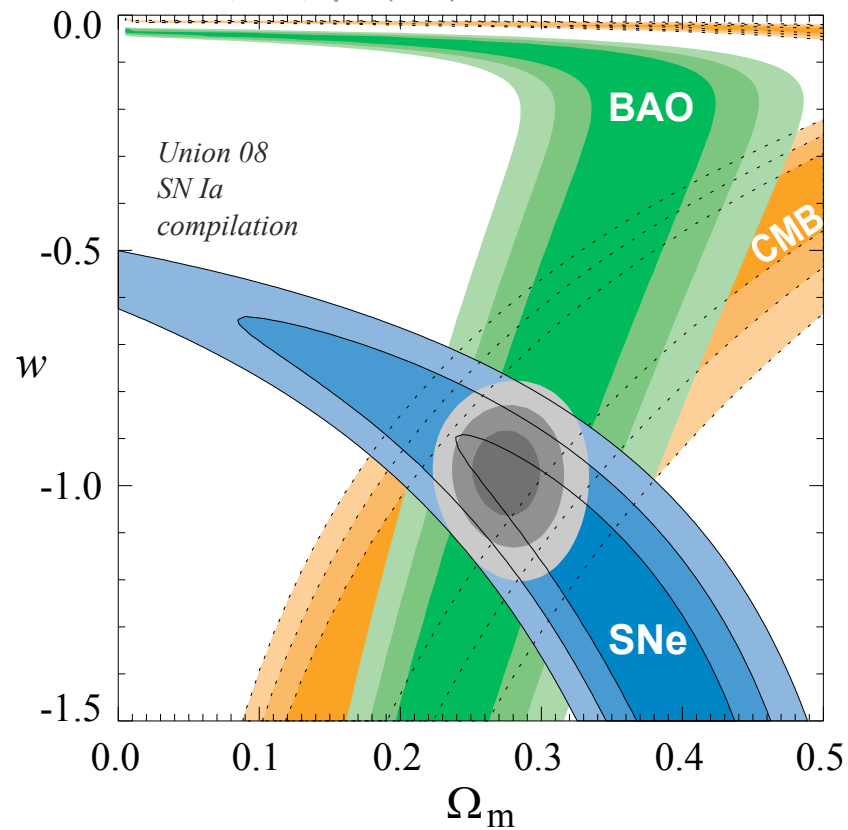

Recall: **Dark Matter** is in
“halos” around galaxies

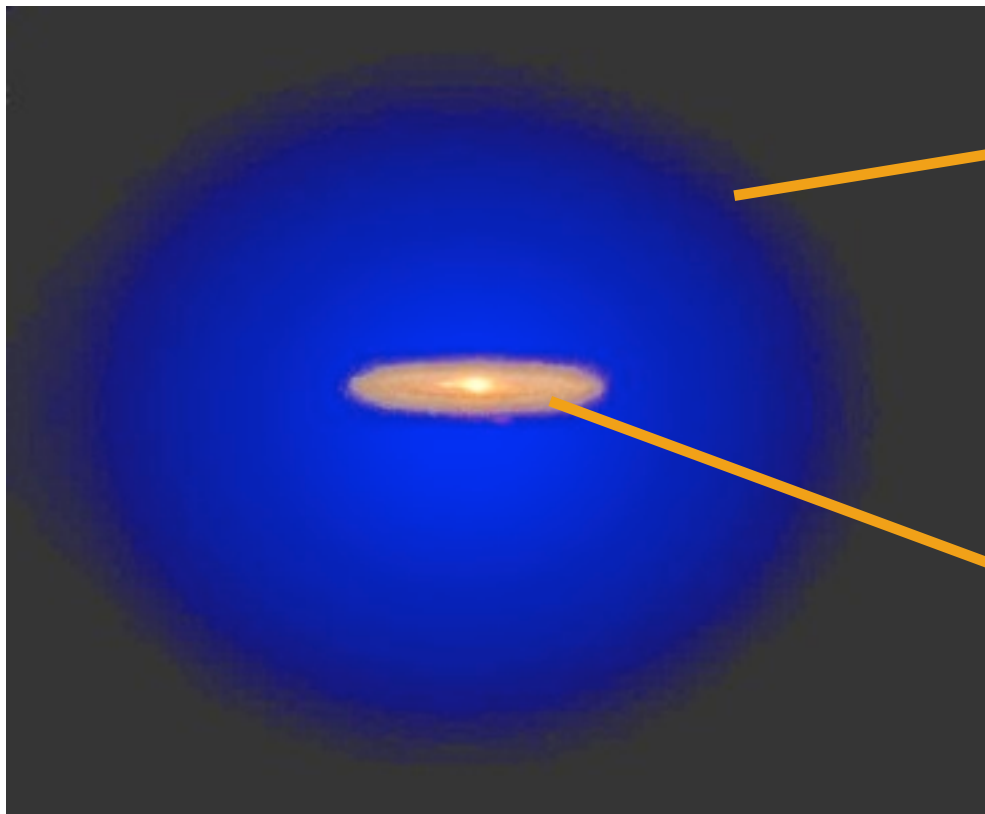

(invisible)

Dark Matter halo

(visible) light
from galaxy

Actual photo of dark energy

Dark Energy



- Universe is dominated by something other than dark matter
- This new component - “dark energy” - makes the universe undergo **accelerated expansion**
- This new component is largely **smooth**
- Other than that, we don’t know much!

Fine Tuning Problems I: “Why Now?”

Dark Energy was much less important at earlier epochs.

So why is it comparable to matter today?

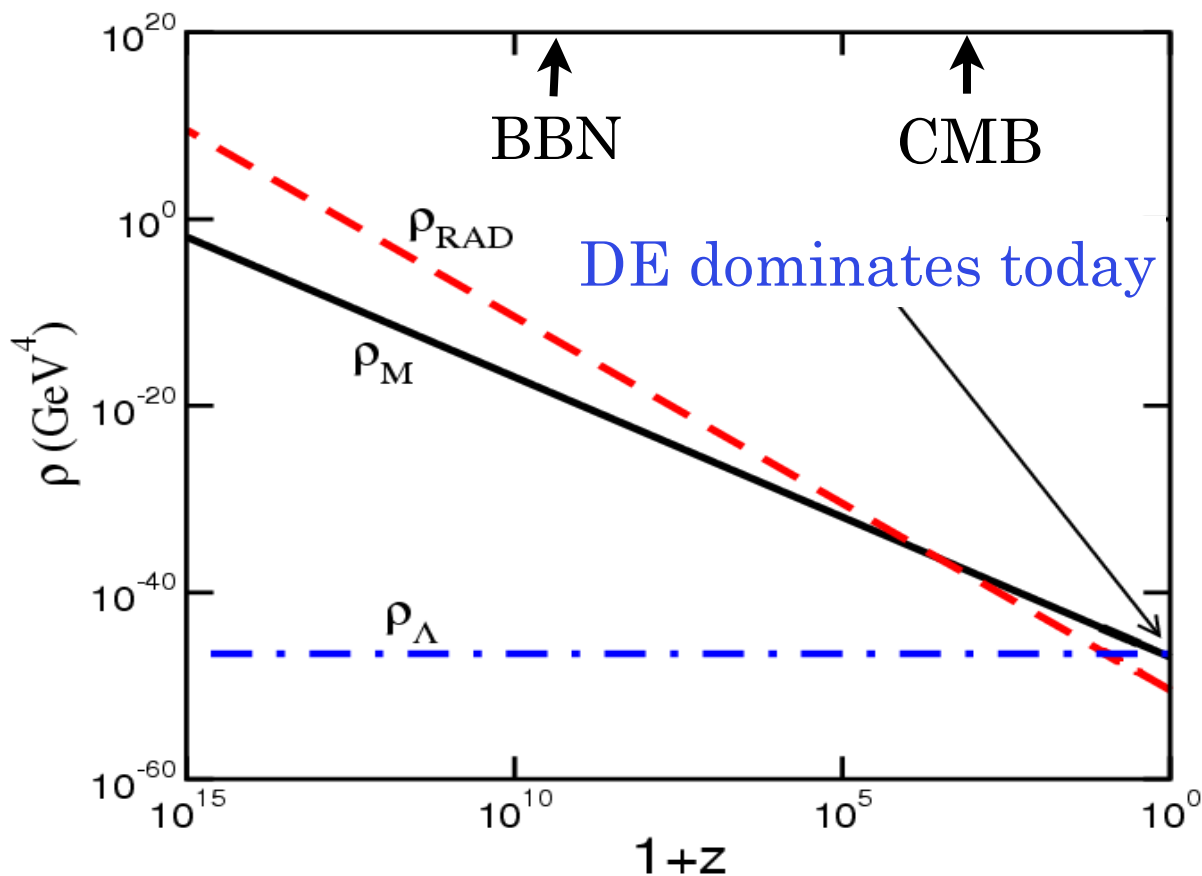

$$\frac{\rho_{\text{DE}}(z)}{\rho_{\text{M}}(z)} = \frac{\Omega_{\text{DE}}}{\Omega_{\text{M}}} (1+z)^{3w}$$

Fine Tuning Problems II: “Why so small”?

Vacuum Energy: QFT predicts it to be cutoff scale

$$\rho_{\text{VAC}} = \frac{1}{2} \sum_{\text{fields}} g_i \int_0^\infty \sqrt{k^2 + m^2} \frac{d^3 k}{(2\pi)^3} \simeq \sum_{\text{fields}} \frac{g_i k_{\text{max}}^4}{16\pi^2}$$

Measured: $(10^{-3} \text{eV})^4$

SUSY scale: $(1 \text{ TeV})^4$

Planck scale: $(10^{19} \text{ GeV})^4$

} **60-120** orders of magnitude
smaller than expected!

(Bizarre) Consequences of DE

- Geometry is not destiny any more! Fate of the universe (accelerates forever vs. recollapses etc) depends on the **future behavior** of DE
- In the accelerating universe, **galaxies are leaving our observable patch** -> the sky will be empty in 100 billion years
- **Under certain conditions** we will have a **Big Rip** - galaxies, stars, planets, our houses, atoms, and then the fabric of space itself will rip apart!

Steven Weinberg:

“Right now, not only for cosmology but for elementary particle theory, this is the bone in our throat”

Frank Wilczek:

“... maybe the most fundamentally mysterious thing in all of basic science”

Ed Witten:

“... would be the number 1 on my list of things to figure out”

Michael Turner:

“... the biggest embarrassment in theoretical physics”

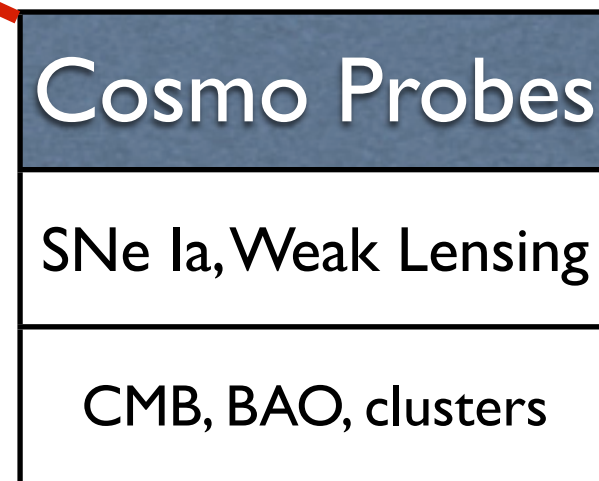
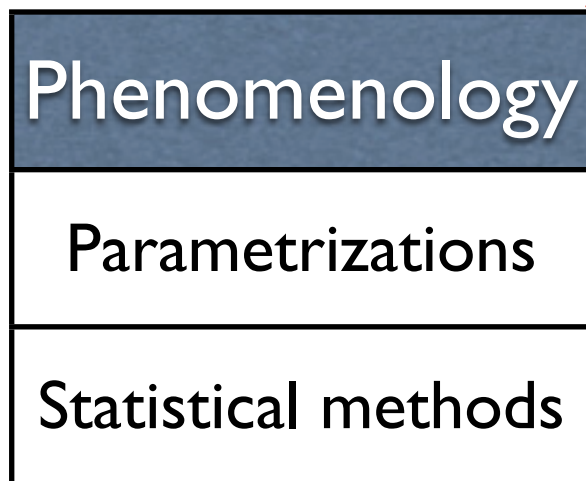
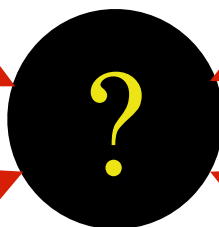
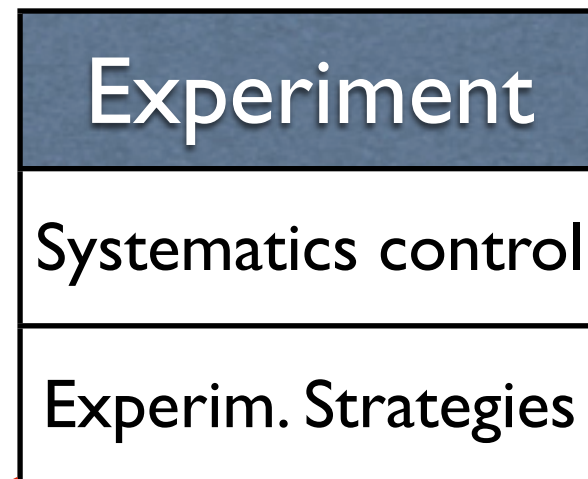
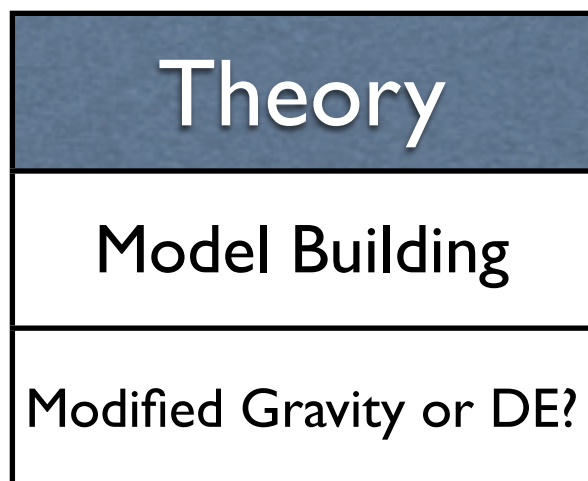

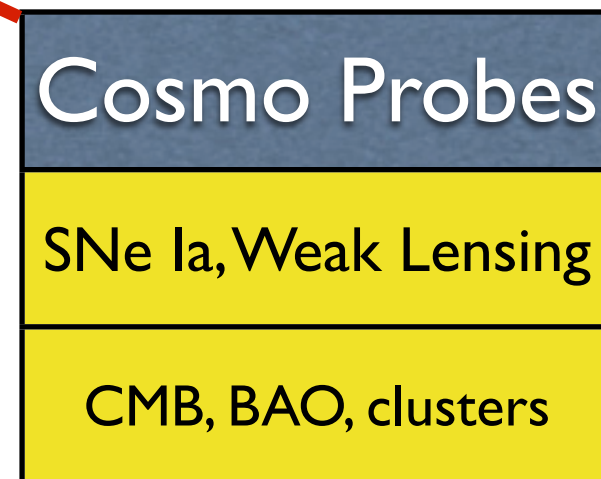
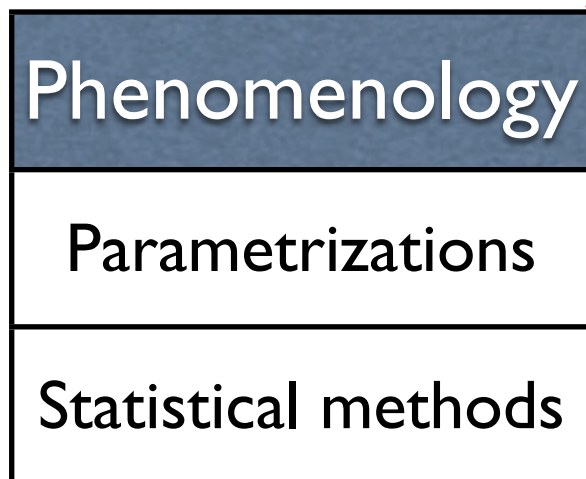
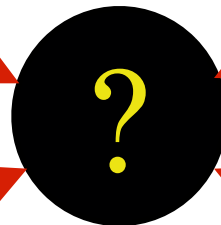
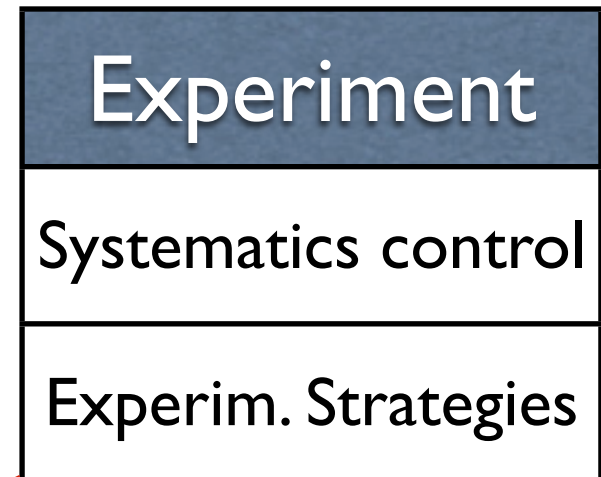
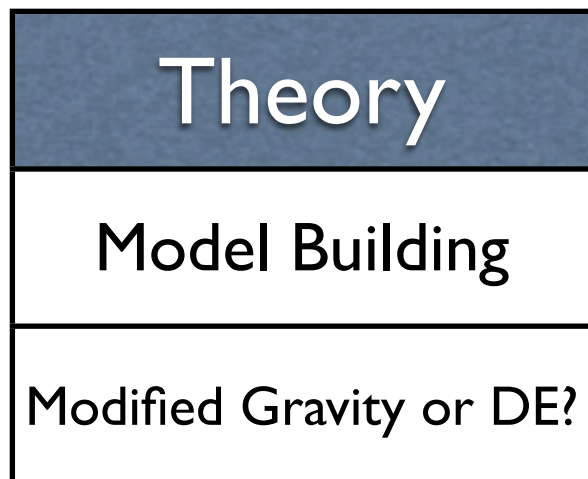

Cosmological Probes of Dark Energy

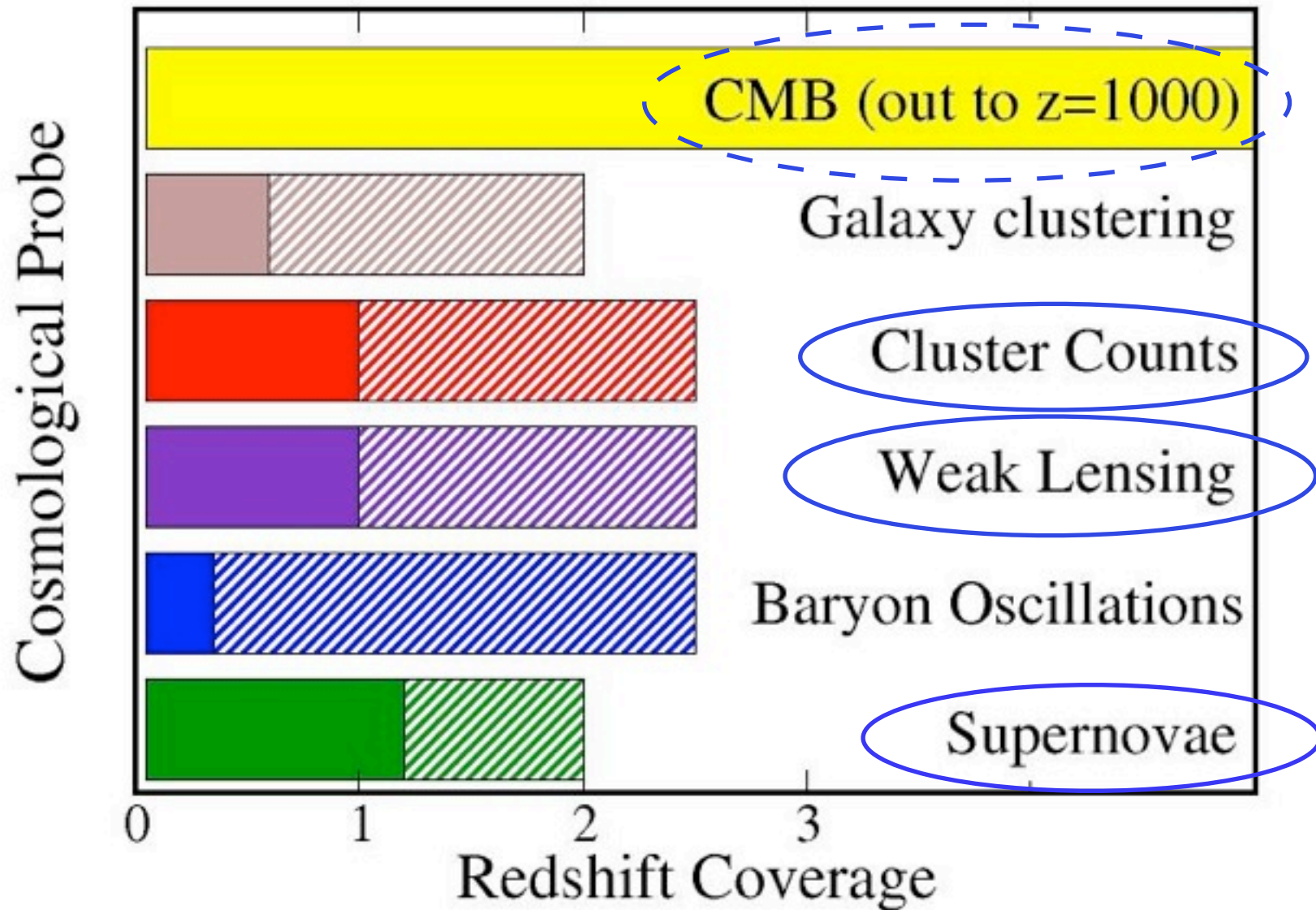

Weak Gravitational Lensing



Credit: NASA, ESA and
R. Massey (Caltech)

Key advantage: measures distribution of matter, not light

Weak Gravitational Lensing

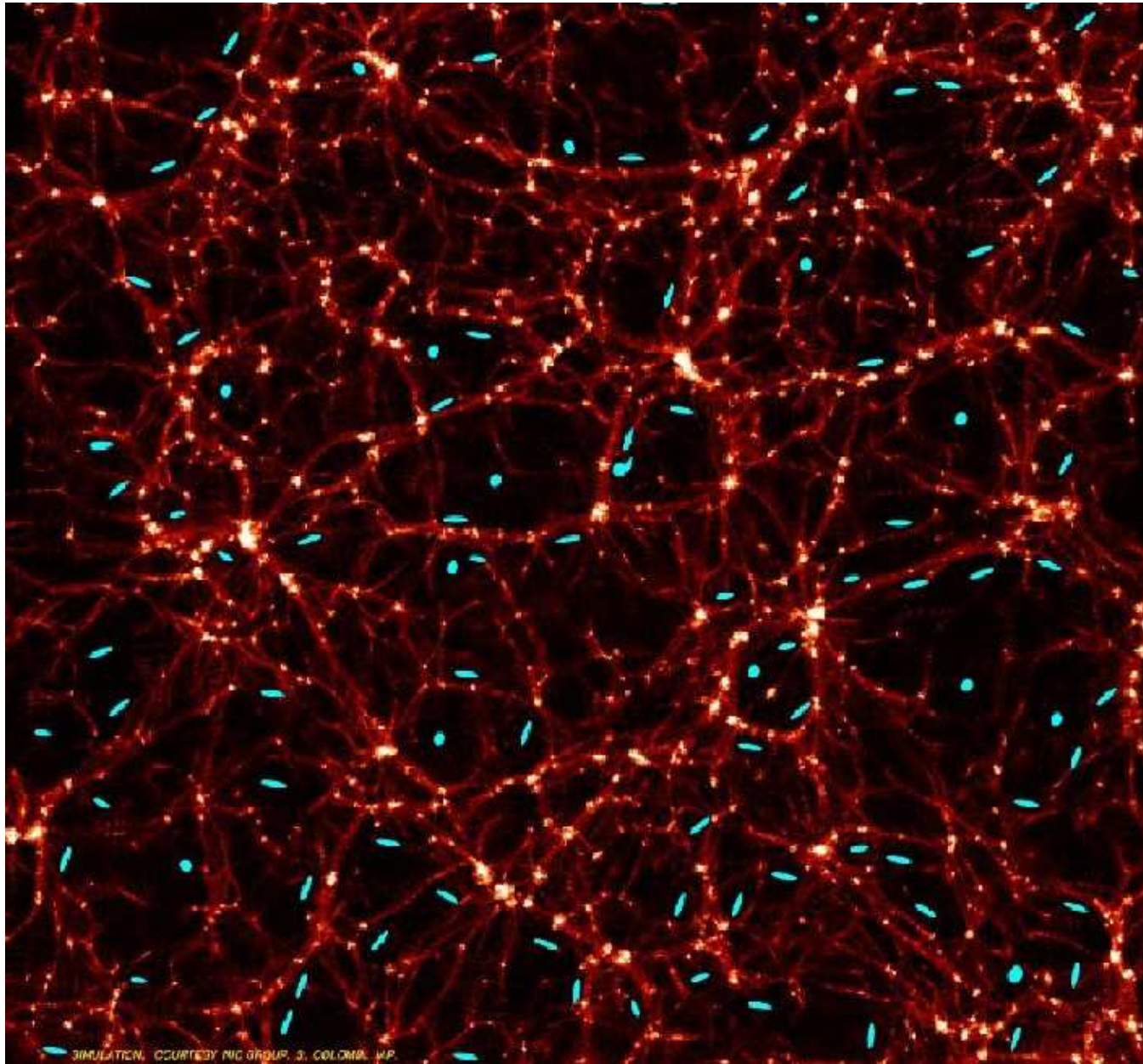

SIMULATION. COURTESY NIC GROUP, S. COLOMBAI, I.A.P.

Credit: Colombi & Mellier

Weak Lensing and Dark Energy

WL measures integral over the line of sight:

$$P_{\text{shear}} \simeq \int_0^{\infty} W(r) P_{\text{matter}}(r) dr$$

galaxy shear clustering
(measure)

distance,
volume factors
(theory → DE)

(dark) matter
clustering
(theory → DE)

- Probes integrated matter density; also sensitive to **Dark Energy** through distance, volume factors

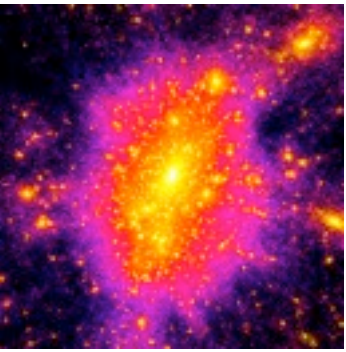

Counting galaxy clusters

cluster number
(measure)

$$\frac{d^2 N}{d\Omega dz} = n(z) \frac{r(z)^2}{H(z)}$$

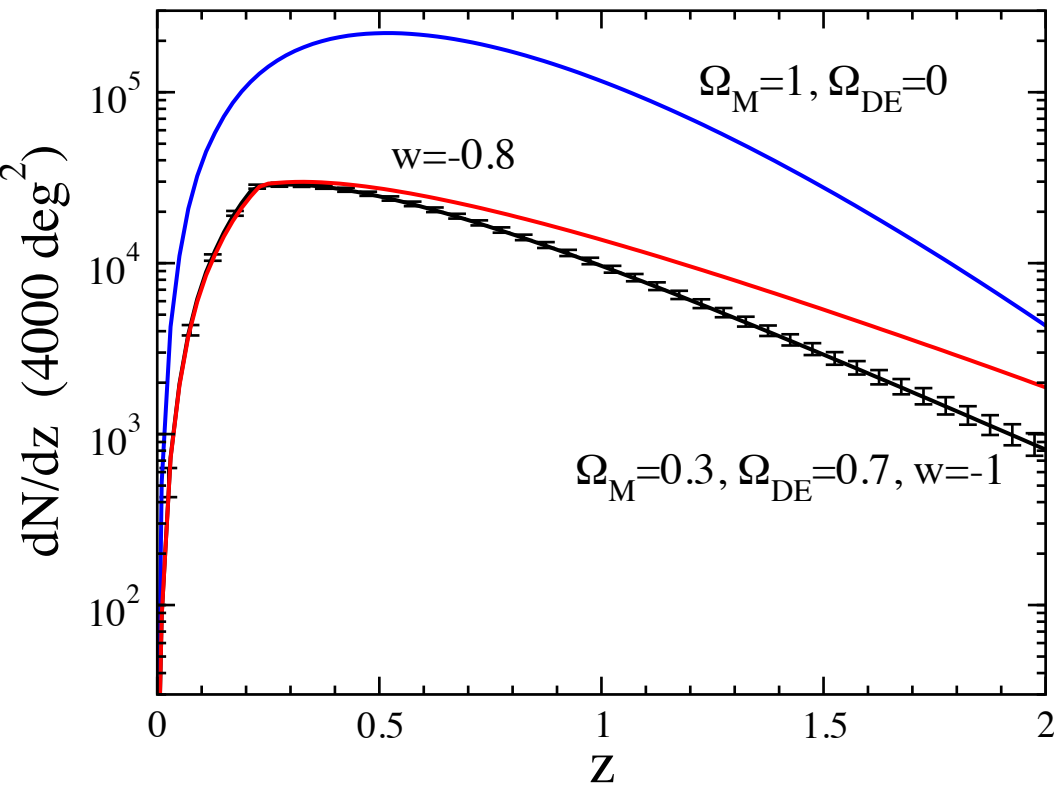

cluster num. density
(simulations \rightarrow DE)

distance factors
(theory \rightarrow DE)

CMB and Dark Energy

$$T = 2.726 \text{ K}$$

$$\frac{\delta T}{T} \approx 10^{-5}$$

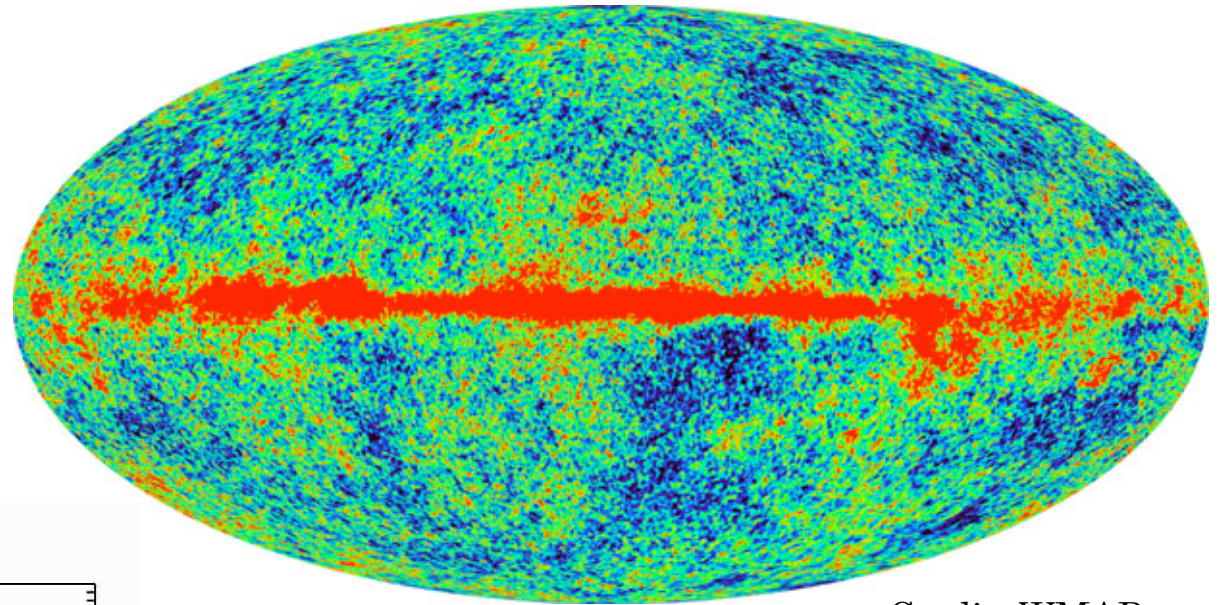

Credit: WMAP team

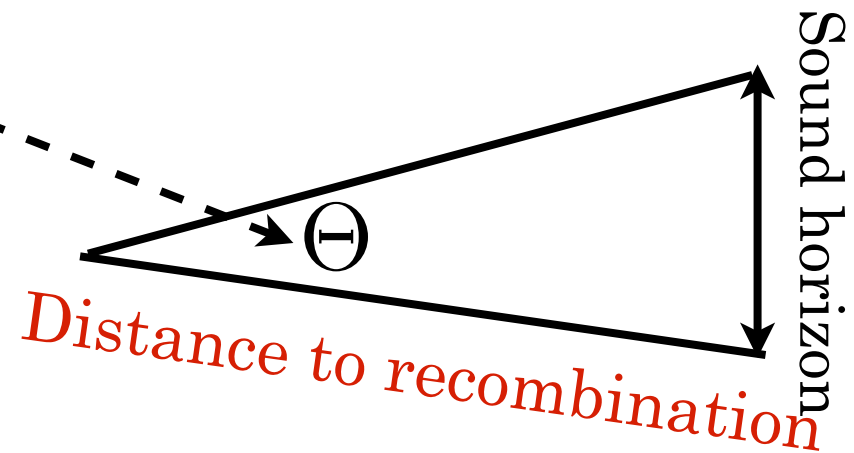
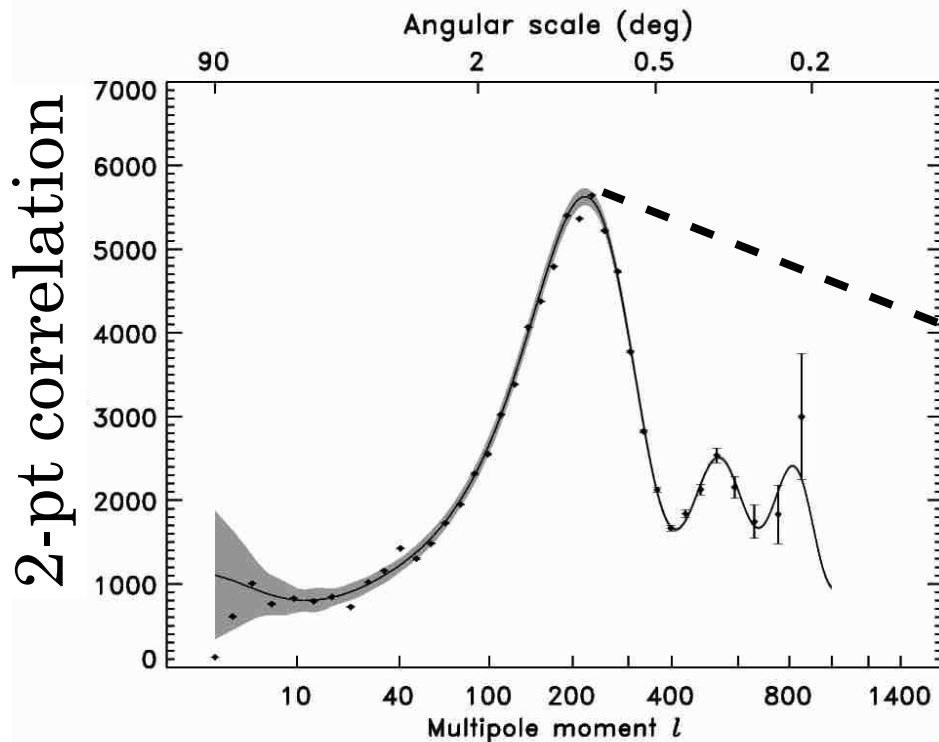

Bennett et al 2003 (WMAP collaboration)

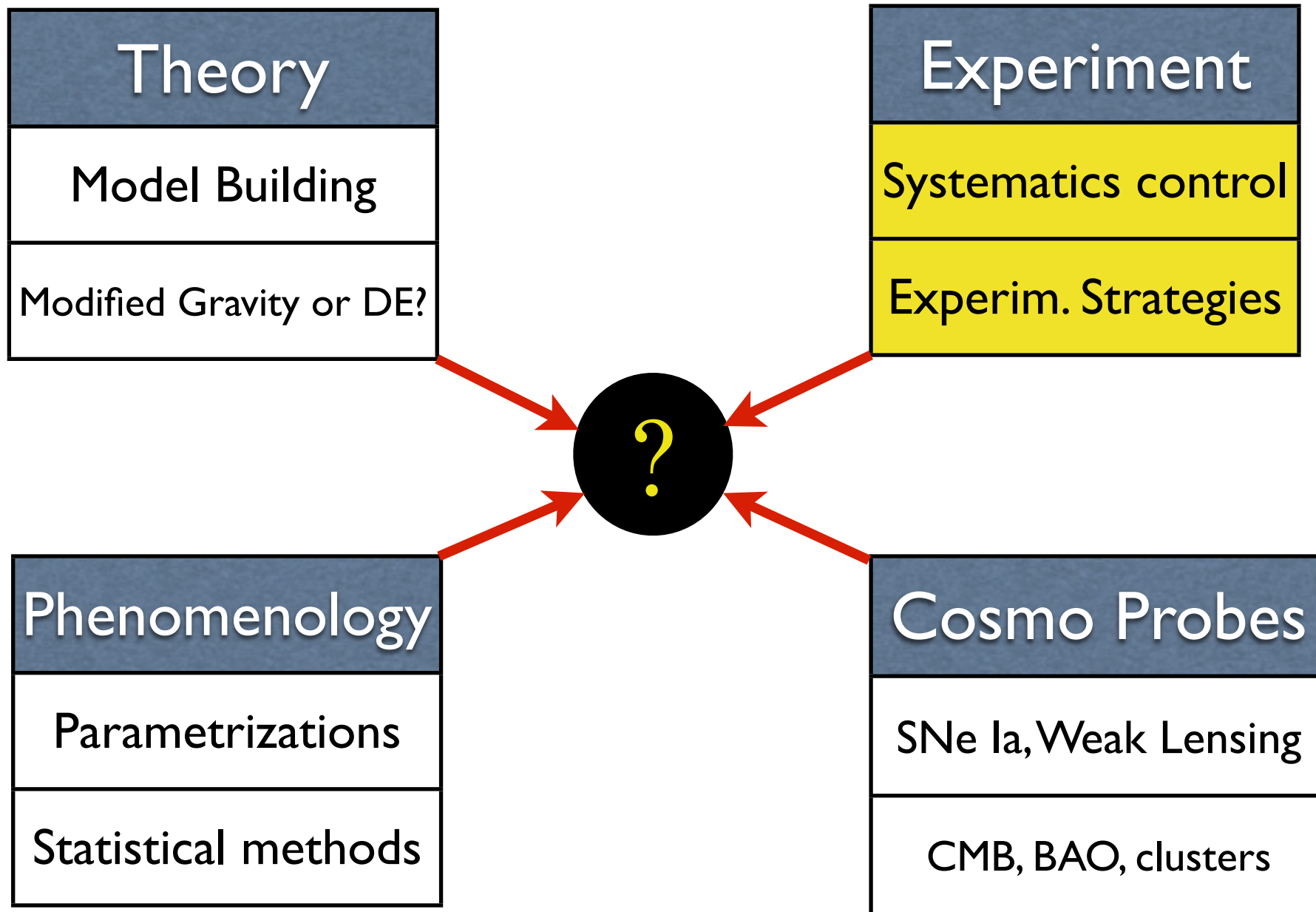

Hyper Suprime-Cam	Optical imaging, 8-m	WL,CL,BAO	III
ALPACA	Optical imaging, 8-m	SN, BAO, CL	III
LSST	Optical imaging, 6.8-m	All	IV
AAT WiggleZ	Spectroscopy, 4-m	BAO	II
HETDEX	Spectroscopy, 9.2-m	BAO	III
PAU	Multi-filter imaging, 2-3-m	BAO	III
SDSS BOSS	Spectroscopy, 2.5-m	BAO	III
WF MOS	Spectroscopy, 8-m	BAO	III
HSHS	21-cm radio telescope	BAO	III
SKA	km ² radio telescope	BAO, WL	IV
<hr/>			
Space-based:			
<i>JDEM Candidates</i>			
ADEPT	Spectroscopy	BAO, SN	IV
DESTINY	Grism spectrophotometry	SN	IV
SNAP	Optical+NIR+spectro	All	IV
<i>Proposed ESA Missions</i>			
DUNE	Optical imaging	WL, BAO, CL	
SPACE	Spectroscopy	BAO	
eROSITA	X-ray	CL	
<i>CMB Space Probe</i>			
Planck	SZE	CL	
<i>Beyond Einstein Probe</i>			
Constellation-X	X-ray	CL	IV

Upcoming Experiments

Planck

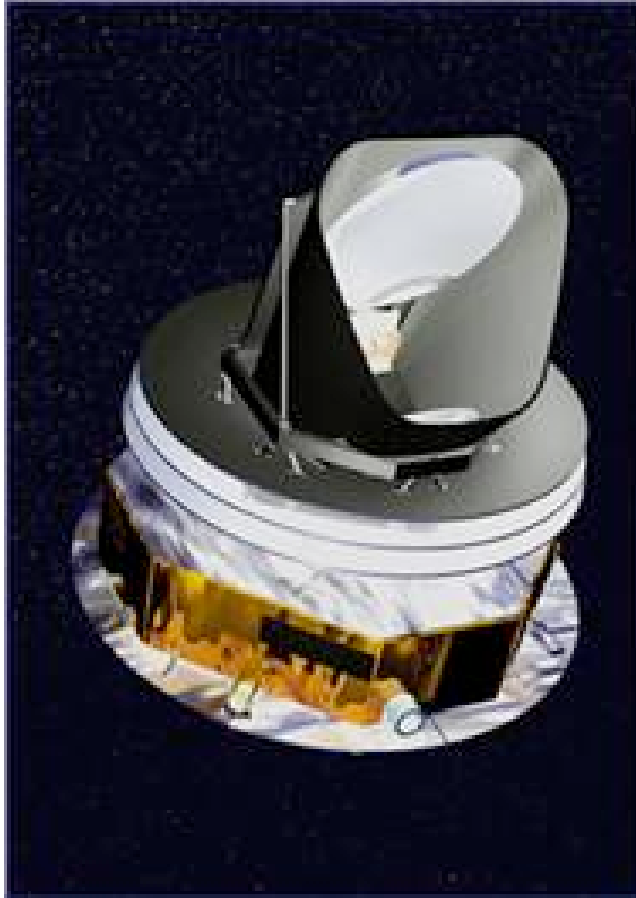

South Pole Telescope



LSST

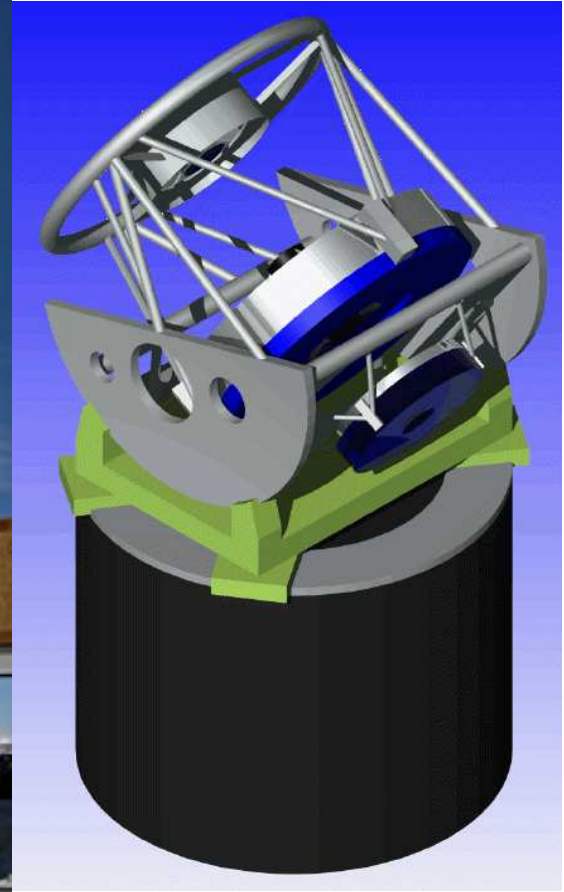

Lots and lots of data coming our way

Dark Energy Survey

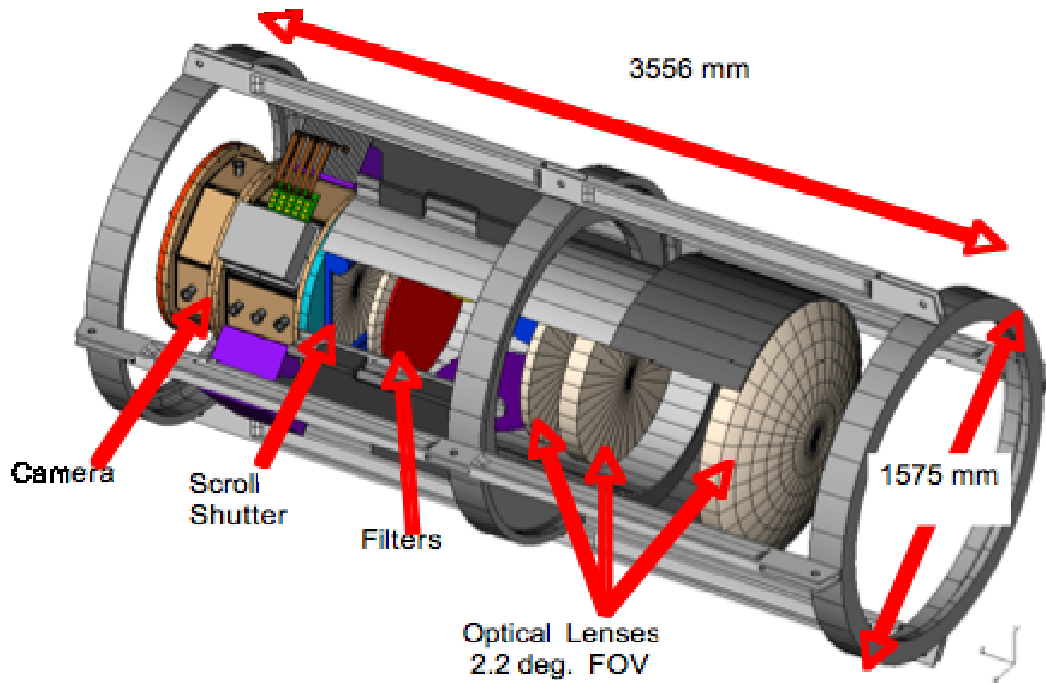

Blanco 4m telescope in Chile

Four techniques to probe Dark Energy:

1. Number Counts of clusters
2. Weak Lensing
3. SNe Ia
4. Angular clustering of galaxies

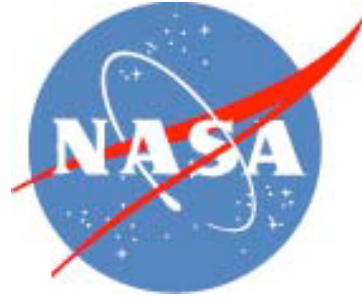

NASA-DOE

Joint Dark Energy Mission

Paul Hertz / NASA
Robin Staffin / DOE

Endorsed by

Raymond L. Orbach
Director of the Office of Science
Department of Energy
September 24, 2003

Edward J. Weiler
Associate Administrator for Space Science
NASA
September 25, 2003

DESTINY

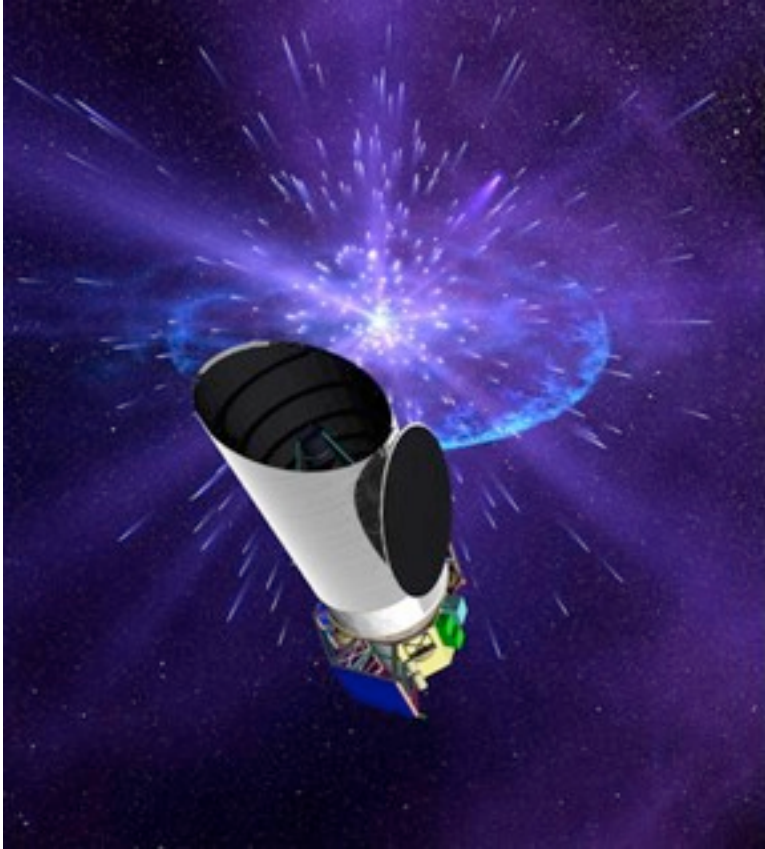

ADEPT

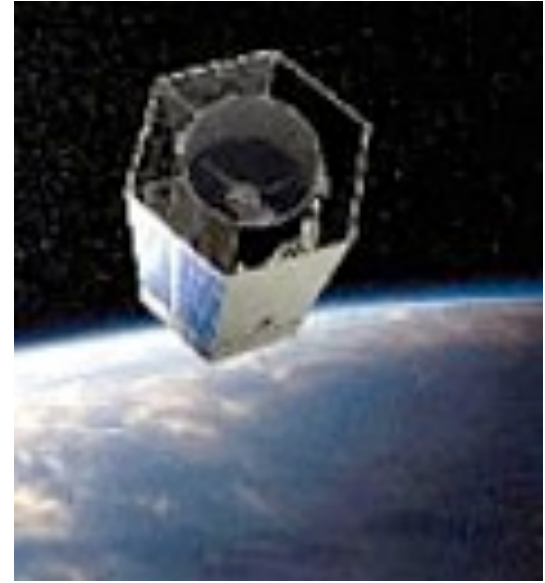

SNAP

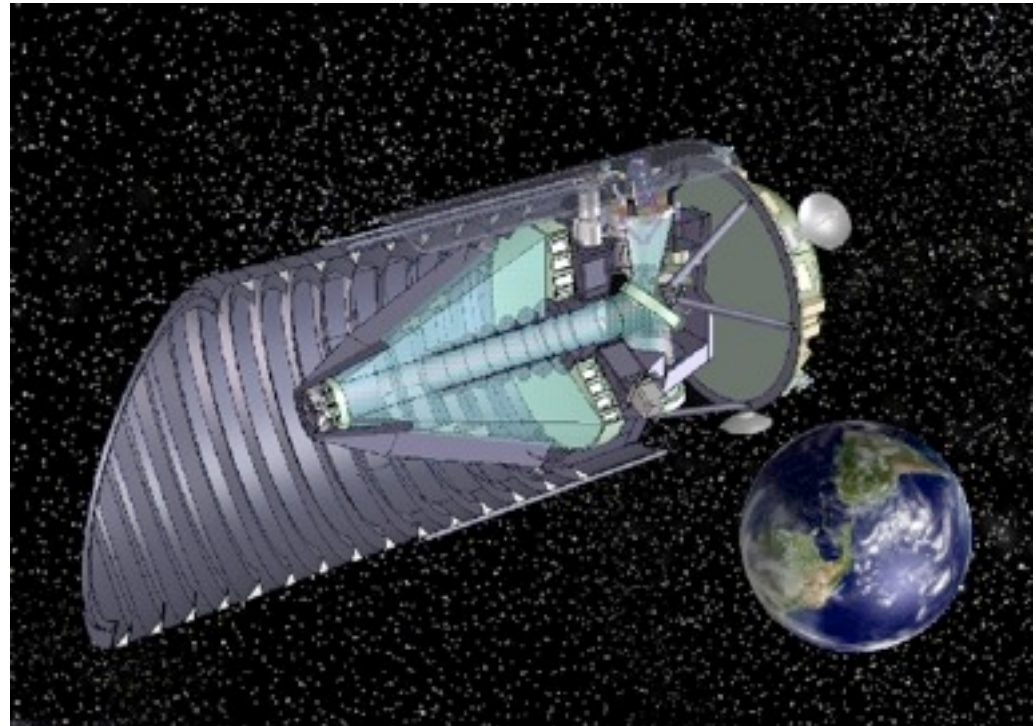

SuperNova/Acceleration Probe

~2500 SNe at $0.1 < z < 1.7$

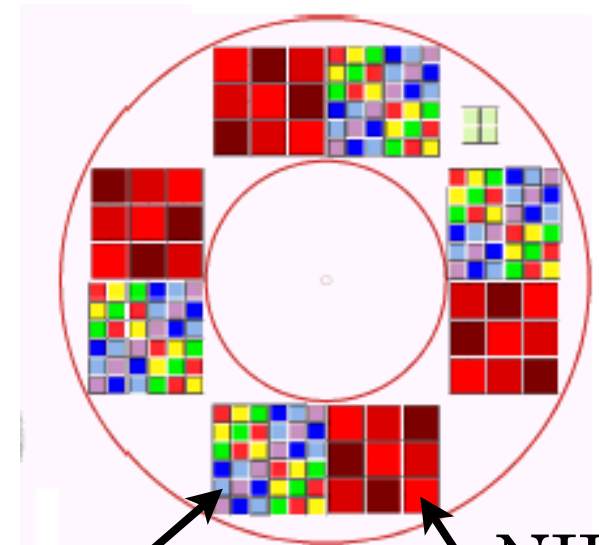
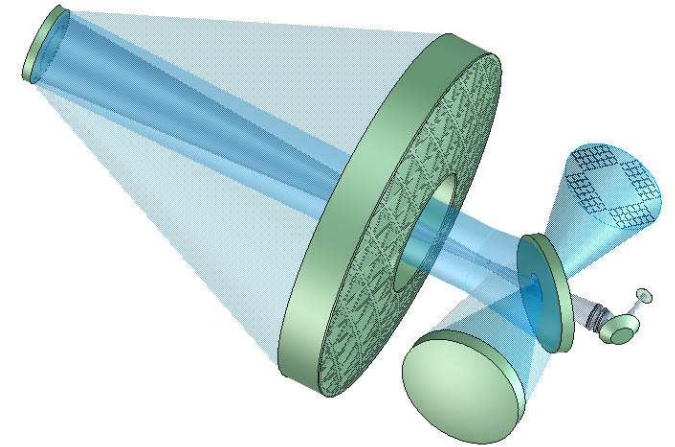

Visible (CCDs)

NIR
(HgCdTe)

required

non-linearity

CDM assumption

determining mass,
selection function

Systematic errors!

Weak Lensing **Experimental Systematics**: redshift errors

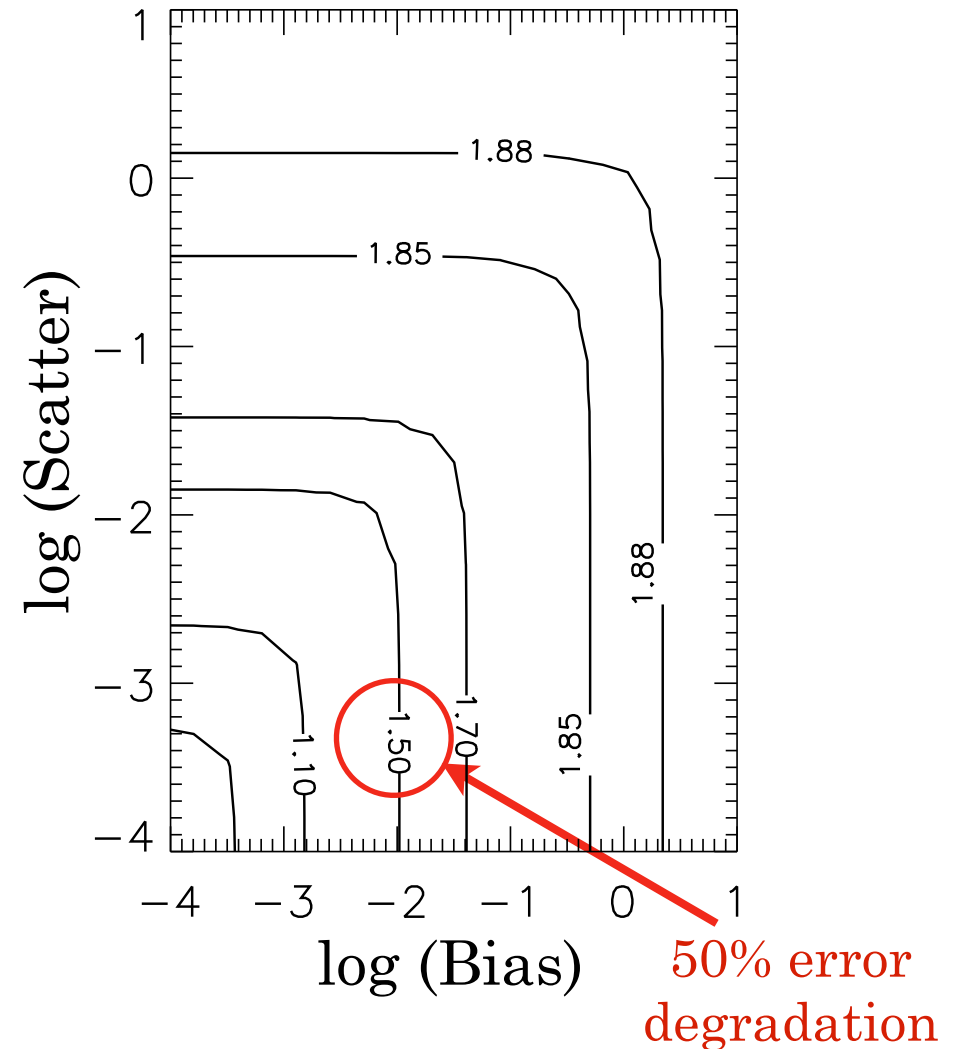
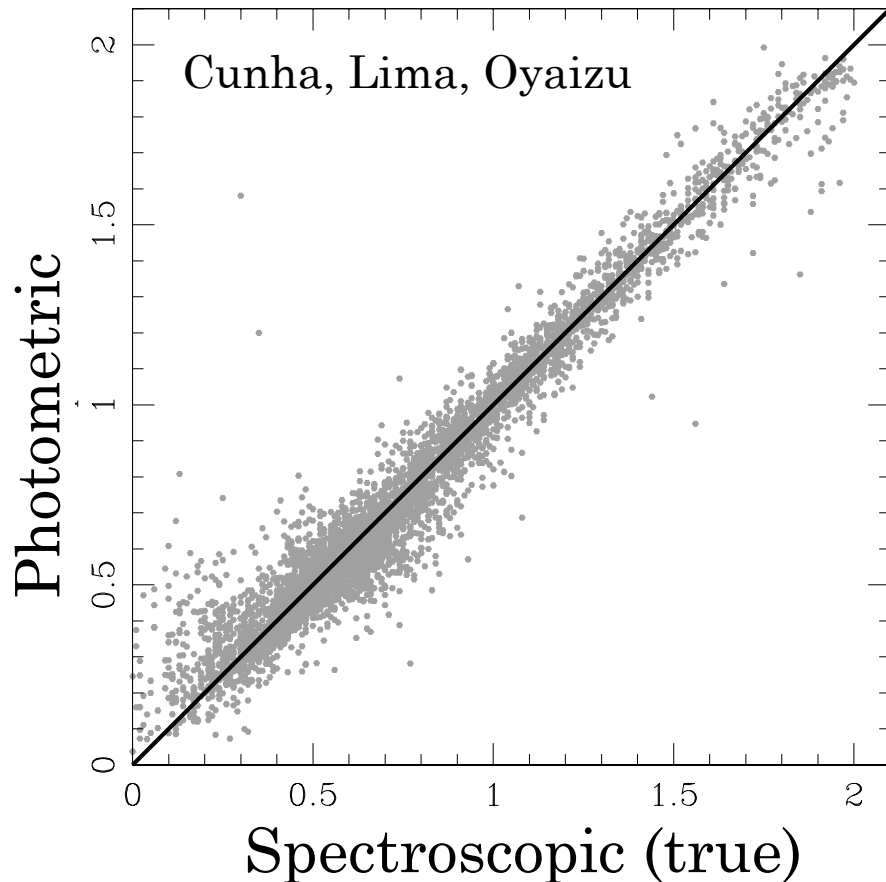

Weak Lensing: Theory Systematics

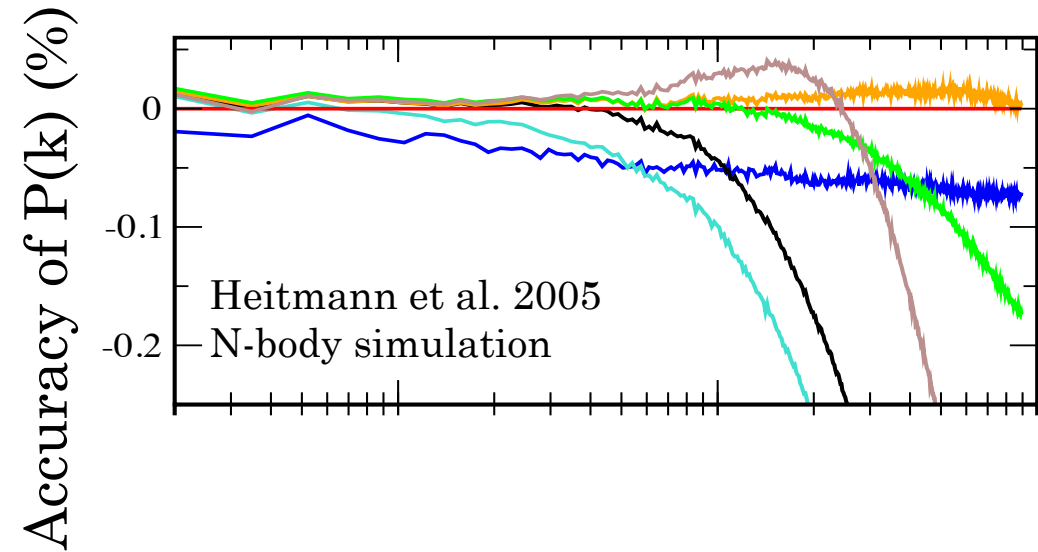
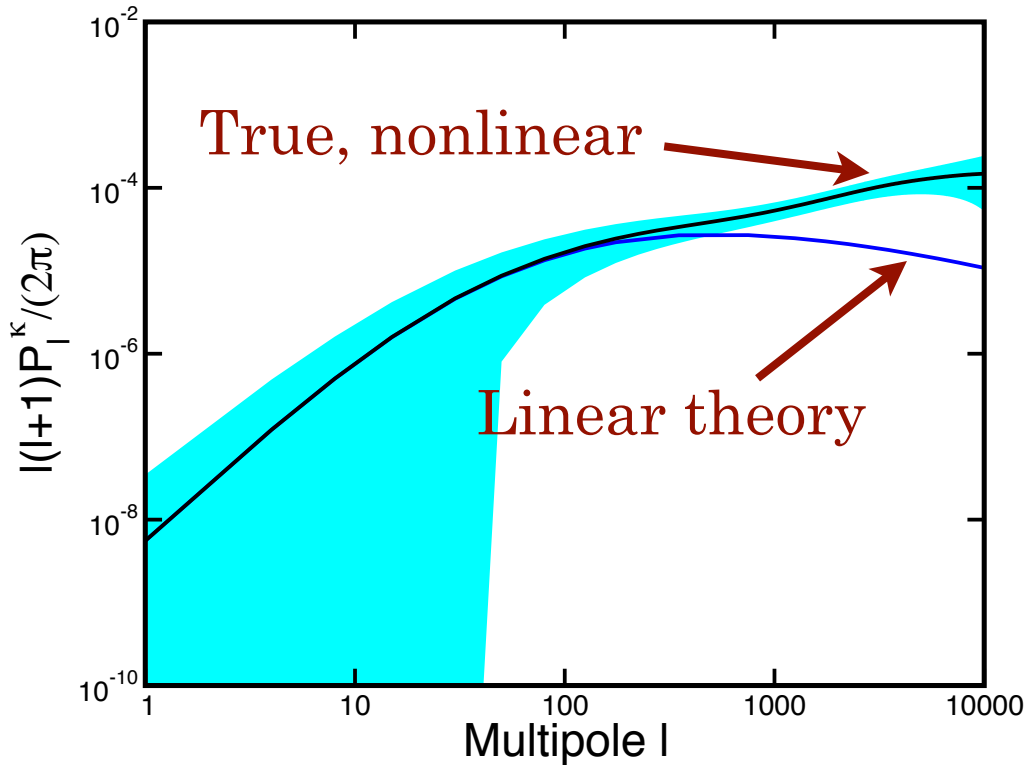

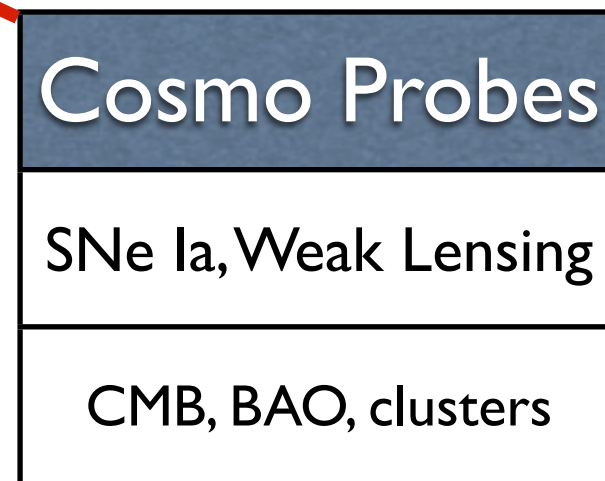
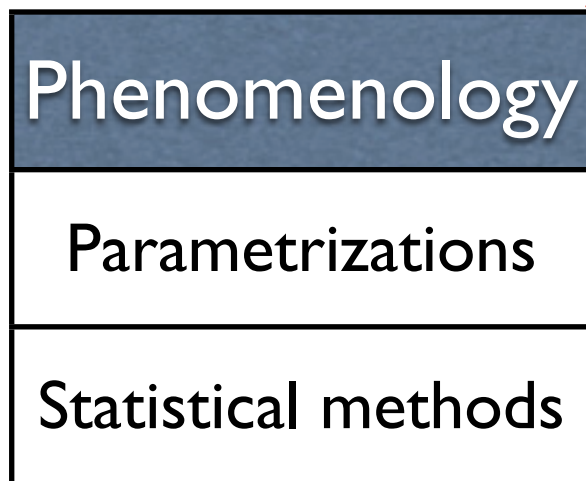
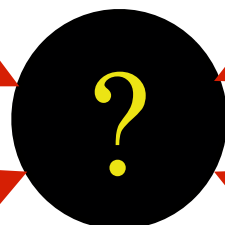
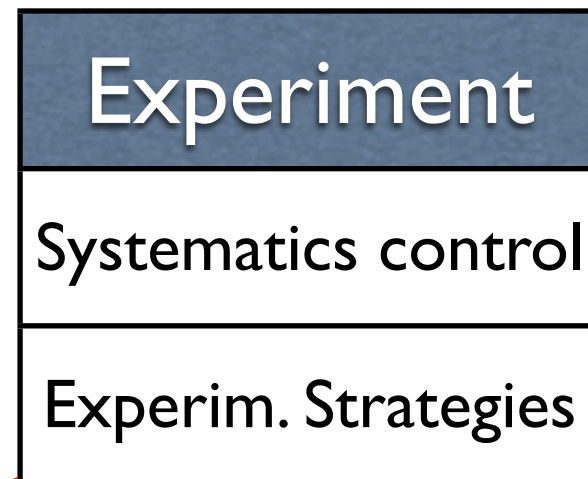
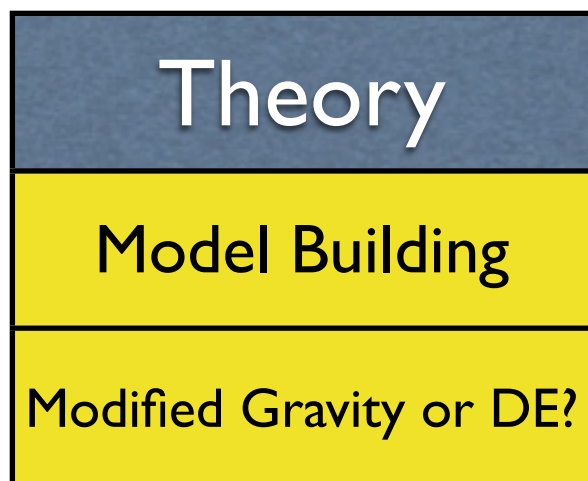

What if gravity deviates from GR?

For example:

$$H^2 - F(H) = \frac{8\pi G}{3} \rho, \quad \text{or} \quad H^2 = \frac{8\pi G}{3} \left(\rho + \frac{3F(H)}{8\pi G} \right)$$



Modified gravity



Dark energy

Modified gravity proposals

- Introduce modifications to GR (typically near horizon scale) to explain the observed acceleration of the universe
- Make sure Solar System tests are passed (can be hard)
- Constrain the MG theory using the cosmological data
- Try to distinguish MG vs. “standard” DE (can be hard!)

Example: DGP braneworld theory

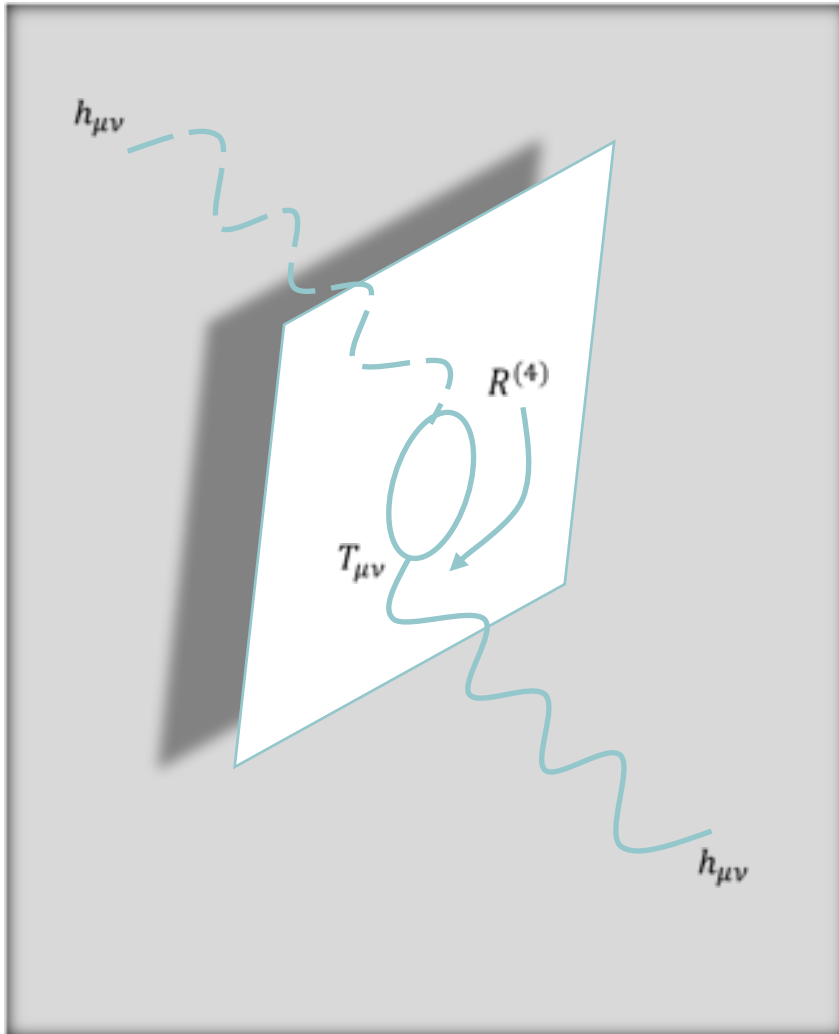

- 1 extra dimension (“bulk”) in which only gravity propagates
- matter lives on the “brane”
- weakening of gravity at large distances = appearance of DE

Credit: Iggy Sawicki

Dvali, Gabadadze & Porrati 2000; Deffayet 2001

The structure of DGP

$$H^2 - \frac{H}{r_c} = \frac{8\pi G}{3} \rho$$

r_c is a free parameter
(to be consistent with
observation, $r_c \sim 1/H_0$)

New scale $r_* = (r_g r_c^2)^{1/3}$

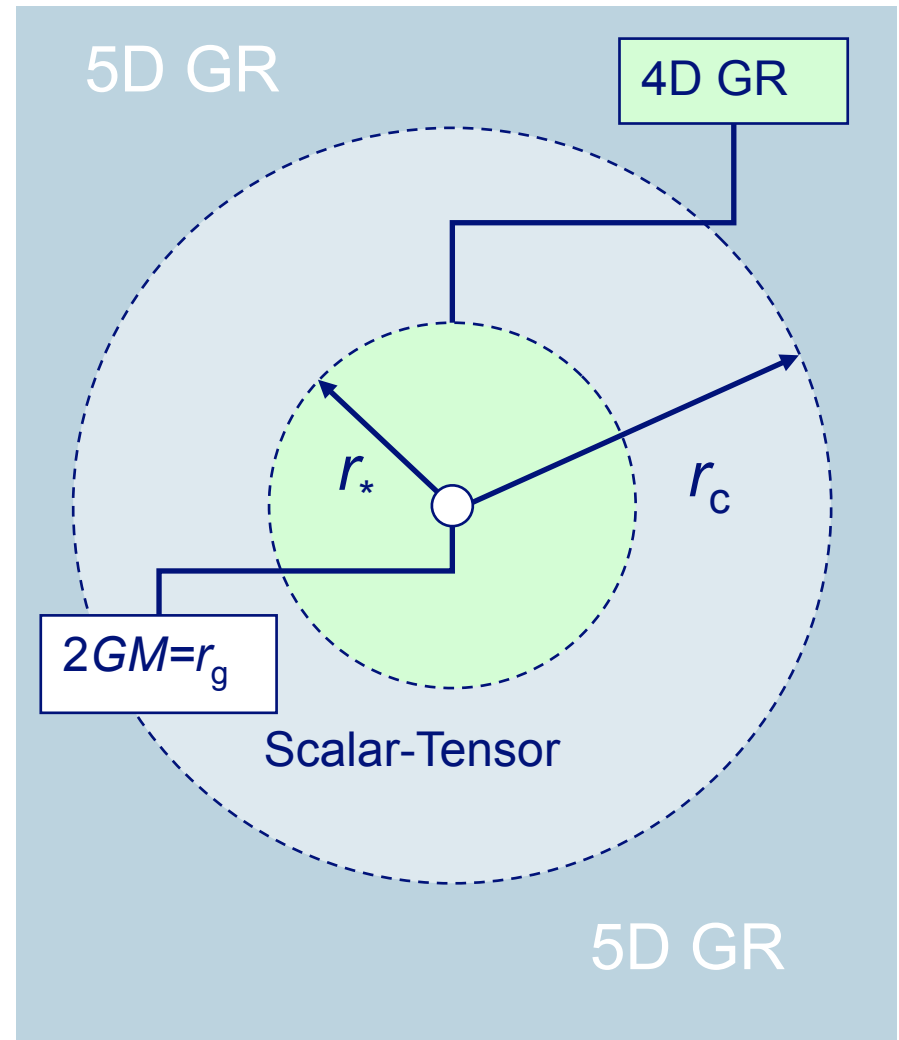

Credit: Iggy Sawicki

How to “detect” Modified Gravity

- In standard GR, expansion history determines distances **and** growth of structure

$$\ddot{\delta} + 2H\dot{\delta} - 4\pi\rho_M\delta = 0$$

- So check if this is true by measuring separately

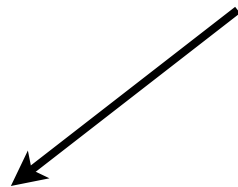

Distances

(a.k.a. kinematic probes)

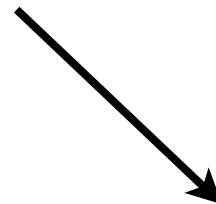

Growth

(a.k.a. dynamical probes)

Are they mutually consistent? (given GR)

Conclusions

- The accelerating universe -- powered by dark energy -- was directly discovered in 1998
- Dark energy's origin and nature are very mysterious
- DE makes up about 75% of energy density; its energy is (roughly) unchanging with time
- “Why now? Why so small?”
- Many upcoming experiments
- Little theoretical progress so far
- One of the biggest mysteries in science today