

CONSTRAINTS ON VARIABLES IN SYNTAX



by

JOHN ROBERT ROSS

B.A., Yale University (1960)

M.A., University of Pennsylvania (1964)

SUBMITTED IN PARTIAL FULFILLMENT
OF THE REQUIREMENTS FOR THE
DEGREE OF DOCTOR OF
PHILOSOPHY

at the

MASSACHUSETTS INSTITUTE OF
TECHNOLOGY

September, 1967

Signature of Author
Department of Modern Languages, August 21, 1967

Certified by
Thesis Supervisor

.....
Chairman, Departmental Committee
on Graduate Students

DEDICATION

To four of my teachers

Bernard Bloch, Zellig Harris, Noam Chomsky and Morris Halle

who have awoken in me, and intensified
by their ever-deeper insights, the desire
to understand Man through an unraveling
of the mysteries of his language; and

to my mother,

Eleanor Campbell Mott Ross,

who, although she does not understand
how anyone could want to study language,
has spared no effort to let me study
where, what, and how I want to,

I dedicate this thesis.

CONSTRAINTS ON VARIABLES IN SYNTAX

by

John Robert Ross

submitted to the Department of Modern Languages and Linguistics on August 21, 1967, in partial fulfillment of the requirements for the degree of Doctor of Philosophy.

ABSTRACT

This thesis attempts a definition of the notion syntactic variable, a notion which is of crucial importance if the central fact of syntax, that there are unbounded syntactic processes, is to be accounted for. A set of constraints on variables, some universal, some language particular, is presented, and the question of what types of syntactic rules they affect is raised. It is shown that these constraints, in conjunction with the notion of command, partition phrase markers into islands -- the maximal domains of applicability of all rules of a specified type.

Thesis Supervisor: Noam Chomsky
Title: Professor of Linguistics

FRAGESTELLUNG

The following anecdote is told of William James. I have been unable to find any published reference to it, so it may be that I have attributed it to the wrong man, or that it is apocryphal. Be that as it may, because of its bull's-eye relevance to the study of syntax, I have retold it here.

After a lecture on cosmology and the structure of the solar system, James was accosted by a little old lady.

"Your theory that the sun is the center of the solar system, and that the earth is a ball which rotates around it, has a very convincing ring to it, Mr. James, but it's wrong. I've got a better theory," said the little old lady.

"And what is that, madam?" inquired James politely.

"That we live on a crust of earth which is on the back of a giant turtle."

Not wishing to demolish this absurd little theory by bringing to bear the masses of scientific evidence he had at his command, James decided to gently dissuade his opponent by making her see some of the inadequacies of her position.

"If your theory is correct, madam," he asked, "what does this turtle stand on?"

"You're a very clever man, Mr. James, and that's a very good question," replied the little old lady, "but I have an

answer to it. And it's this: the first turtle stands on the back of
a second, far larger, turtle, who stands directly under him."

"But what does this second turtle stand on?" persisted
James patiently.

To this, the little old lady crowed triumphantly,

"It's no use, Mr. James -- it's turtles all the way
down."

ACKNOWLEDGEMENTS

This thesis ends an overly long career as a professional student, a career which has been a joy to me, but a trial to the many teachers and administrators who have gritted their teeth and forgiven the lateness of papers and assignments (several are still late), the frequency with which I asked ill thought-out questions, and my chronic unpunctuality. They have put up with all this in the hope that something might become of me someday. To these friends I can only offer this thesis, in the hope that it will in part repay their confidence in me.

For aid and support beyond the call of duty, I must single out the following for special gratitude:

The Deutscher Akademische Austauschdienst, who gave me a chance to dabble around at three German universities, apparently learning nothing but in reality finally realizing that it was time to stop dabbling and study seriously;

The Woodrow Wilson Foundation, who gave me one last chance that I had no right to, sending me to the University of Pennsylvania, where at last I did stop dabbling;

Don Walker, of the MITRE Corporation, who allowed me to spend the summer of 1963 at MITRE, a summer in which I produced nothing, but learned more through reading and talking than in any comparable period of my life;

Naomi Sager, for whom I worked for almost a year as a research assistant on the String Analysis Project of the University of Pennsylvania, and who never complained about the extent to which I neglected my job;

Hu Matthews, who I worked for when I first came to MIT, again giving precious little to show for it;

John Olney, of the Systems Development Corporation, who supported my work during a pleasant California summer in 1965;

The National Institutes of Health, for a Pre-Doctoral Fellowship during the year 1965-1966; and

Susumu Kuno, of the Harvard Computation Laboratory, who supported my work during 1965-1966, and eliminated many oversights and inadequacies in my work with insightful counterexamples.

The typing of a thesis this size is a job of Herculean proportions, and proofreading it can be almost as bad. It is therefore with great pleasure that I thank Ellie Dunn, Patricia Wanner, and, because she did the bulk of it with a speed and industry which were incredible, especially Lorna Howell. The care and accuracy with which these girls prepared the manuscript made proofreading as enjoyable as I have ever known it.

I would also like to express my thanks to Dwight Bolinger, of Harvard, for the care that he has devoted to reading, and commenting on, various papers of mine, some related closely to the thesis, some not, and for the many deep insights into syntax that his comments afford.

To Roman Jakobson, I owe a special debt: not only has he always given me freely of his time, for discussion of a wide range of problems, but he loaned me his office in Boylston Hall, so that I could break out of the becalmed state I had gotten into. Without his generosity, the thesis would not have been finished this summer.

Each member of the MIT Linguistics Department has helped me overcome some obstacle in my work. Hu Matthews helped me to see

the nature of the Sentential Subject Constraint (cf. § 4.4) more clearly, and to formulate it. Ed Klima's fundamental insight that pruning interacts with the constraints of Chapter 4 (cf. § 4.1.1) has been the indirect source of most of the thesis. And Paul Kiparsky's insight that factive clauses behave the same with respect to feature-changing rules and reordering rules (cf. § 6.4) leads directly to what I regard as one of the most important concepts developed below --the concept of islands.

My debt to the remaining three members is less direct, but no less important, for all that. It was from Paul Postal's lectures in 1964 and 1965 that the conception of a highly abstract, but probably universal, deep structure, which contained only nouns and verbs, emerged. It is to the end of establishing the correctness of this conception that most of Lakoff's and my work, including this thesis, has been directed.

Morris Halle, in addition to running a department which contains an atmosphere uniquely conducive to discovery, has somehow been able to get across to me the all-important distinction between solutions to problems (i.e., devices that work, but...) and explanations for phenomena, the most crucial distinction in science.

What I owe to Noam Chomsky is incalculable. Unless he had formulated the A-over-A principle (cf. Chapter 2), it is doubtful whether I would have even noticed the problems which this thesis is devoted to solving. I disagree with him on many particular points of

analysis, but since it was really from his work that I learned how to construct an argument for or against a proposed analysis, my ability to disagree also derives from him. I am deeply grateful to him and to Halle for helping me to understand what it is that a theory is.

It is impossible to thank all my friends individually for their contributions, so I will select three. David Perlmutter, aside from the great amount I have learned from his work, has also taught me a lot about my own, through serving as a backboard for my new ideas and pointing out unclarities and inconsistencies. He has also helped proofread the thesis, for all of which I thank him. Bruce Fraser has helped in every kind of way -- linguistically, technically, financially. I cannot thank him sufficiently.

This thesis is an integral part of a larger theory of grammar which George Lakoff and I have been collaborating on for the past several years. Since there is close interaction between the theory of variables reported here and almost all facets of the larger theory, it is impossible to guess what kind of thesis I would have written on this topic had we not worked together in delving down into deeper and deeper layers of turtles. Where I can remember, I have tried to give him credit for particular ideas of his. I ask him to accept this general word of thanks for all the places I have forgotten.

Finally, I come to my family. Since in my view cats are as necessary as air or water, I thank our cats Krishna and Aristotle

for deigning to stay with us and seasoning our existence. To my new son Daniel Erik I owe the added impetus that pushed me to finish the thesis this summer. The ease with which this three-month-old child dislodged the completion of the thesis from its central position in the universe, to assume this position himself, made me realize that once he became ambulatory, thesis writing of all sorts would cease.

I have no words with which to thank my wife Elke-Edda. The writing of this thesis has been as much of an ordeal for her as it has for me, for which I beg her forgiveness. For making my life as easy as it could be, under the sword of Damocles, I thank her with my heart.

Table of Contents

Dedication.....	ii
Abstract.....	iii
Fragestellung.....	iv
Acknowledgements.....	vi
<u>Introduction</u>	
1.0.....	1
1.1.....	7
1.2.....	10
Footnotes.....	11
<u>The A-over-A Principle</u>	
2.0.....	12
2.1.....	14
2.2.....	16
2.3.....	24
2.4.....	25
2.4.0.....	25
2.4.1.....	26
2.4.2.....	29
2.5.....	34
Footnotes.....	37
<u>Tree Pruning</u>	
3.0.....	41
3.0.0.....	41

3.0.1.....	44
3.0.2.....	45
3.1.....	47
3.1.1.....	47
3.1.1.1.....	47
3.1.1.2.....	49
3.1.1.3.....	51
3.1.1.3.1.....	51
3.1.1.3.2.....	62
3.1.1.3.3.....	69
3.1.1.4.....	73
3.1.2.....	74
3.1.3.....	80
3.1.4.....	88
3.1.5.....	91
3.1.6.....	94
3.1.7.....	96
3.1.8.....	98
3.1.9.....	99
3.2.....	100
Footnotes.....	102

Constraints on Reordering Transformations

4.0.....	117
4.1. The Complex NP Constraint.....	118

4.1.1.....	118
4.1.2.....	120
4.1.3.....	126
4.1.4.....	128
4.1.5.....	139
4.1.6.....	148
4.1.7.....	158
4.2. The Coordinate Structure Constraint.....	158
4.2.1.....	158
4.2.2.....	161
4.2.3.....	167
4.2.4.....	174
4.2.4.1.....	174
4.2.4.2.....	178
4.2.4.3.....	186
4.2.4.4.....	190
4.2.5.....	195
4.3. The Pied Piping Convention.....	196
4.3.1.....	196
4.3.2.....	206
4.3.2.0.....	206
4.3.2.1.....	207
4.3.2.2.....	217
4.3.2.3.....	223
4.3.2.4.....	228
4.3.2.5.....	236

4.3.3.....	240
4.4. The Sentential Subject Constraint.....	241
4.4.1.....	241
4.4.2.....	245
4.4.3.....	252
4.5.....	255
Footnotes.....	256

Bounding, Command, and Pronominalization

5.0.....	267
5.1. Bounding.....	268
5.1.1.....	268
5.1.1.1.....	268
5.1.1.2.....	280
5.1.1.3.....	285
5.1.1.4.....	296
5.1.2.....	298
5.1.2.1.....	298
5.1.2.2.....	301
5.1.2.3.....	306
5.1.3.....	312
5.1.3.1.....	312
5.1.3.2.....	318
5.1.3.2.1.....	318
5.1.3.2.2.....	322

5.1.3.2.3.....	325
5.1.3.2.4.....	329
5.1.3.2.5.....	331
5.1.3.2.6.....	333
5.1.4.....	334
5.2. Command.....	338
5.2.1.....	338
5.2.1.0.....	338
5.2.1.1.....	338
5.2.1.2.....	340
5.2.2.....	343
5.2.3.....	347
5.2.3.1.....	347
5.2.3.2.....	352
5.3. Pronominalization.....	354
5.3.0.....	354
5.3.1.....	354
5.3.2.....	358
5.3.3.....	363
5.3.3.0.....	363
5.3.3.1.....	364
5.3.3.2.....	365
5.3.3.3.....	367
5.3.3.4.....	368

5.3.4.....	369
5.4.....	372
Footnotes.....	374

On the Notion "Reordering Transformation"

6.0.....	382
6.1. Some Rules Obeying the Constraints.....	383
6.1.0.....	383
6.1.1.....	385a
6.1.1.1.....	385a
6.1.1.2.....	386
6.1.1.3.....	388
6.1.1.4.....	391
6.1.1.5.....	392
6.1.1.6.....	394
6.1.1.7.....	396
6.1.2.....	398
6.1.2.0.....	398
6.1.2.1.....	398
6.1.2.2.....	400
6.1.2.3.....	401
6.1.2.4.....	404
6.1.2.5.....	406
6.1.2.6.....	406
6.1.2.7.....	408

6.1.2.8.....	409
6.1.3.....	410
6.1.3.0.....	410
6.1.3.1.....	411
6.1.3.2.....	415
6.1.3.3.....	416
6.2. Chopping Rules.....	421
6.2.0.....	421
6.2.1.....	422
6.2.2.....	428
6.2.3.....	432
6.2.4.....	434
6.2.4.1.....	434
6.2.4.2.....	437
6.2.5.....	442
6.3. Reordering over Variables.....	442
6.3.1.....	442
6.3.2.....	445
6.3.3.....	447
6.4. Islands.....	449
6.4.0.....	449
6.4.1.....	450
6.4.1.0.....	450

6.4.1.1.....451
6.4.1.2.....456
6.4.1.3.....461
6.4.1.4.....464
6.4.2.....465b
6.4.3.....469
6.4.3.1.....469
6.4.3.2.....477
6.5. **Summary**.....478
Footnotes.....481
7. **Conclusion**.....491
 Bibliography.....495
 Biography.....500

Chapter 1

INTRODUCTION

1.0. The past decade of research on transformational grammar has substantiated amply, to my mind, the claim that the optimal framework for the description of syntactic facts is a set of rules, of two types: context-free phrase structure rules, which generate an infinite set of highly abstract formal objects, underlying (or deep) phrase markers; and grammatical transformations, which map underlying phrase markers onto an infinite set of objects of roughly the same formal character, superficial (or surface) phrase markers.¹ Within this framework, an evaluation measure is provided which must select, from a set of observationally adequate grammars of some language -- i.e., grammars which all generate the observed set of grammatical sentences of the language -- the descriptively adequate grammar -- the grammar which makes correct predictions about strings of words not yet observed, and can thus be said to reflect linguistic knowledge of speakers of the language.² Such knowledge includes intuitions about the immediate constituents of sentences, about similarity among constituents, and about relatedness between sentences. For instance, a descriptively adequate grammar of English would have to predict the following facts about sentence (1.1):

(1.1) A gun which I had cleaned went off.

- a) The main constituent break occurs between cleaned and went; I is a constituent; which I is not; etc.

- b) The constituent a gun which I had cleaned is a constituent of the same kind as the constituent I. Similarly, went off is the same type of constituent as had cleaned, and neither is of the same type as I, a, or off.
- c) Sentence (1.1) is related to sentence (1.2).

(1.2) A gun went off which I had cleaned.

Within a transformational grammar, intuitions of relatedness between sentences are reconstructed by deriving sets of related sentences from the same or highly similar underlying phrase markers by means of slightly differing sets of transformations. As a first approximation, we could postulate a rule like (1.3) to convert the structure underlying (1.1) to the one underlying (1.2)³ (here and elsewhere I will give rules and tree diagrams in a simplified form, as long as it makes no difference for the point under discussion):

$$\begin{array}{rcccc}
 (1.3) & [NP & S] & VP & \\
 & & NP & & OPT \\
 & 1 & 2 & 3 & \implies \\
 & 1 & 0 & 3 + 2 & \\
 & & & & \downarrow
 \end{array}$$

where the phrase marker (P-Marker) associated with (1.1) can be represented as a tree diagram of roughly the following form⁴:

(1.1')

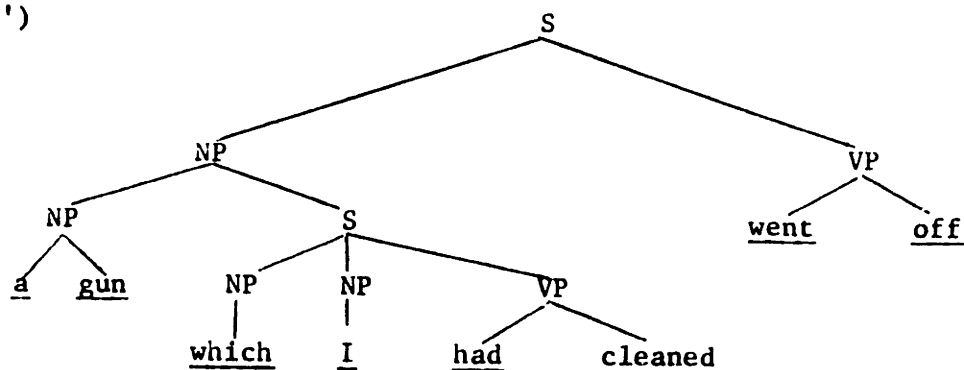

Rule (1.3) would convert (1.1') into the derived P-Marker (1.2')

(1.2')

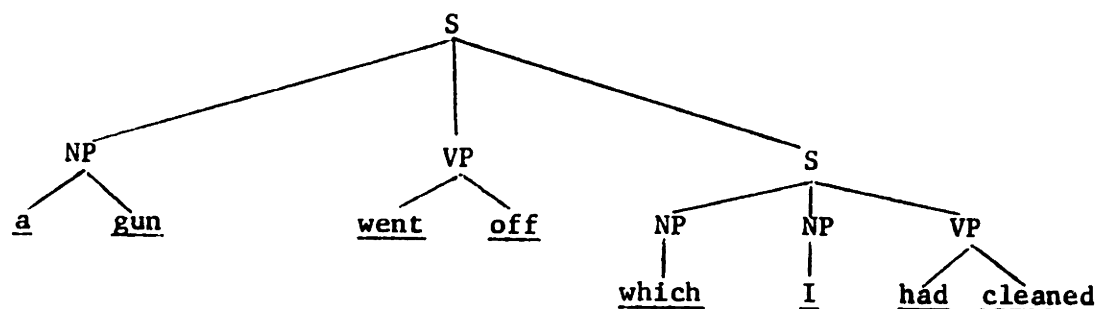

It is fairly easy to demonstrate that the present evaluation measure gives a higher rating to a grammar which has (1.1') as an underlying P-Marker and derives (1.2') from it by using (1.3), than to one which assumes (1.2') is basic; but I will not undertake such a demonstration here, since the point at issue is more general, and these rules I propose are only supposed to illustrate it, not to constitute a complete analysis.

Now consider the sentences (1.4) and (1.5).

(1.4) I gave a gun which I had cleaned to my brother.

(1.5) I gave a gun to my brother which I had cleaned.

To relate (1.4) and (1.5) -- again, I omit the argument which would prove that (1.5) must derive from (1.4) -- some rule like (1.6) would be necessary.

$$\begin{array}{ccccccc}
 (1.6) & \text{NP} & \text{V} & [\text{NP} - \text{S}] & - & \text{PP} & \\
 & \underbrace{\hspace{1.5cm}} & & \text{NP} & & & \text{OPT} \\
 & & 1 & 2 & & 3 & \implies \\
 & & 1 & 0 & & 3 + 2 &
 \end{array}$$

By the provisions of the evaluation measure, we are forced to collapse rules which are similar in certain ways, and (1.3) and (1.6) collapse to yield (1.7):

$$\begin{array}{ccccccc}
 (1.7) & \left\{ \begin{array}{c} \emptyset \\ \text{NP} \quad \text{V} \end{array} \right\} & - & [\text{NP} - \text{S}] & - & \left\{ \begin{array}{c} \text{VP} \\ \text{PP} \end{array} \right\} & \\
 & \underbrace{\hspace{1.5cm}} & & \text{NP} & & & \text{OPT} \\
 & & 1 & 2 & & 3 & \implies \\
 & & 1 & 0 & & 3 + 2 &
 \end{array}$$

Consideration of sentences like (1.8) and (1.9).

(1.8) He let the cats which were meowing out.

(1.9) He let the cats out which were meowing.

and similar sentences might lead one to reformulate (1.7) as an even more general rule, (1.10), which I will call Extrapolation from NP:

(1.10) Extrapolation from NP

$$\begin{array}{ccccccc}
 & \text{X} & & [\text{NP} - \text{S}] & - & \text{Y} & \\
 & & & \text{NP} & & \text{NP} & \text{OPT} \\
 & \underbrace{\hspace{1.5cm}} & & & & & \implies \\
 & & 1 & 2 & & 3 & \\
 & & 1 & 0 & & 3 + 2 &
 \end{array}$$

The symbols X and Y in (1.10) are variables which range over all strings, including the null string. With them, the rule as it stands is much too powerful. For instance, (1.10) would convert (1.11) into the ungrammatical (1.12).

(1.11)

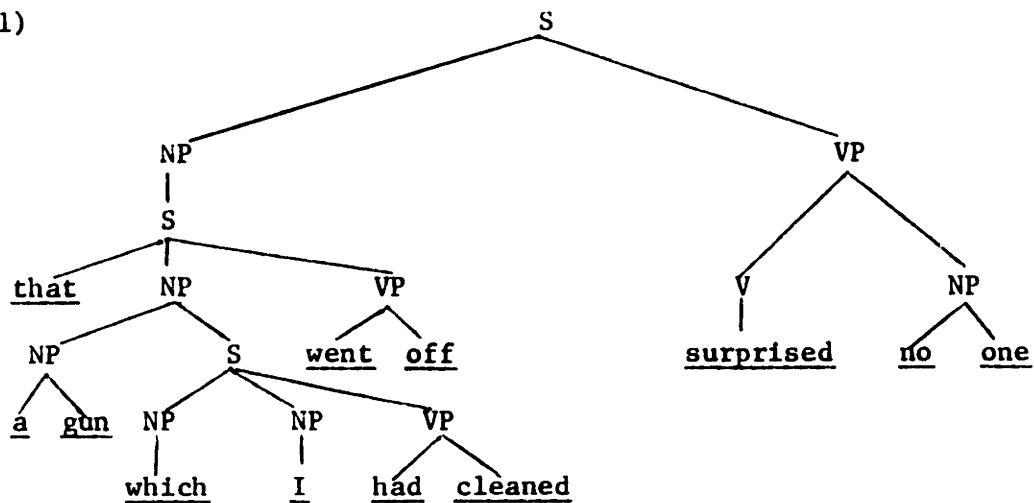

(1.12)

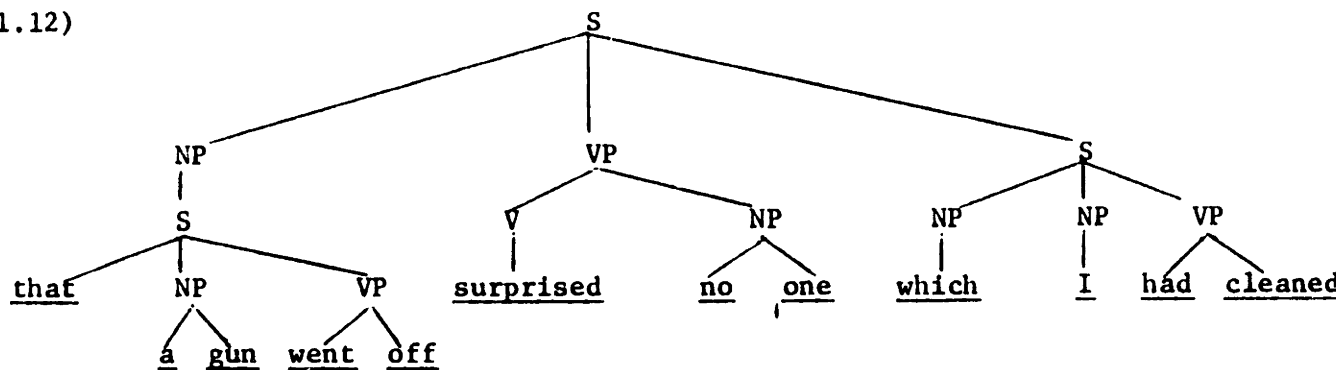

The fact is that an extraposed clause may never be moved outside "the first sentence up," in the obvious interpretation of this phrase, and there are a number of ways of incorporating this fact into

(1.14) What did Bill buy?

What did you force Bill to buy?

What did Harry say you had forced Bill to buy?

What was it obvious that Harry said you had
forced Bill to buy?

A moment's reflection should convince anyone that it is impossible to replace the variable X in (1.13) by some such disjunction as that contained in (1.7): rule (1.13) is not stateable without variables. And yet, just as was the case with rule (1.10), Extrapolation from NP, it is easy to see that (1.13) is far too strong, for it will generate infinitely many non-sentences, such as those in (1.15).

(1.15) * What did Bill buy potatoes and?

* What did that Bill wore surprise everyone?

* What did John fall asleep and Bill wear?

1.1. Sentences and non-sentences like those in (1.14) and (1.15) show that some rules must contain variables but that somehow the power of these variables must be restricted. It is the purpose of this thesis to try to justify a set of constraints on variables, which I will propose in detail in subsequent chapters. There are doubtless many constraints on variables which are peculiar to individual languages, and possibly some which are even peculiar to some rule in some particular language, but I have by and large avoided detailed discussion of these and have instead concentrated my research on constraints which I suspect to be universal.

It is obvious that the limited character of presently available syntactic knowledge reduces drastically the chances of survival of any universals which can be formulated today, for the study of syntax is truly in its infancy. But it will be seen below that the constraints on variables which I will propose are often of such a complex nature that to state them as constraints on rules in particular languages would greatly increase the power of transformational rules and of the kinds of operations on P-Markers they could perform. But to assume more powerful apparatus in a theory than can be shown to be necessary is contrary to basic tenets of the philosophy of science, and so I will tentatively assume that many of the constraints I have arrived at in my investigations of the few languages I am familiar with are universal. It is easy to prove me mistaken in this assumption: if languages can be found whose rules are not subject to these constraints, then the apparatus in theory of generative grammar which provides for the description of language - particular facts will have to be strengthened so that rules like the question transformation in English, (1.13), for instance, can be stated and correctly restricted to exclude ungrammatical sentences like those in (1.15). But until such disconfirming evidence arises, the assumption of a weaker theory for particular languages is dictated by principles of the philosophy of science.

It is probably unnecessary to point out that it is commonplace to limit the power of the apparatus which is available for the description of particular languages by "factoring out" of individual

grammars, principles, conditions, conventions and concepts which are necessary in all grammars: to factor out in this manner is to construct a theory of language. So, for example, when the principle of operation of the syntactic transformational cycle has been specified in linguistic theory, it is unnecessary to include another description of this principle in a grammar of French. And so it is also with such well-known notions as free variation, grammatical sentence, constituent, coordinate structure, verb, and many others. The present work should be looked upon as an attempt to add to this list a precise specification of the notion syntactic variable. This notion is crucial for the theory of syntax, for without it the most striking fact about syntactic processes - the fact that they may operate over indefinitely large domains - cannot be captured. And since almost all transformations either are most generally stated, or can only be stated, with the help of variables, no transformation which contains variables in its structural index will work properly until syntactic theory has provided variables which are neither too powerful nor too weak. It is easy to construct counterexamples such as those in (1.15) for almost every transformation containing variables that has ever been proposed in the literature on generative grammar.¹ It is for this reason that attempts to constrain variables, like those which will be discussed in Chapters 2, 4, and 5, are so important: without the correct set of constraints, it is impossible to formulate almost all syntactic rules precisely, unless one is willing to so greatly

increase the power of the descriptive apparatus that every variable in every rule can be constrained individually. But one pursuing this latter course will soon come to realize that many of the constraints he imposes on individual variables must be stated again and again; that he is missing clear generalizations about language. Thus, the latter course must be abandoned: the only possible course is to search for universal constraints. This thesis is devoted to that search.

1.2. The outline of this work is as follows. In Chapter 2, I will discuss the only previous attempts to limit the power of variables which I know of⁵, Chomsky's A-over-A principle, and two conditions subsequently proposed by him, and demonstrate that they are too strong in some respects and too weak in others. In Chapter 3, I will discuss a notion which will prove indispensable in stating the universal constraints: the notion of node deletion, or tree pruning. In Chapter 4, I state and discuss two putatively universal constraints on variables, which overcome the inadequacies in the principles discussed in Chapter 2, and several less general constraints. The notion of bounding is introduced in Chapter 5. In Chapter 6, I discuss briefly a number of rules and show that these rules are¹ subject to the constraints of Chapter 4, but that not all transformations are subject to these constraints. The question is discussed as to what formal features of rules determine whether the variables in them are subject to the constraints or not. Chapter 7 is a brief recapitulation of the results of the thesis.

Chapter 1

FOOTNOTES

1. For an excellent introductory article on the difference between underlying and superficial structure, cf. Postal (1964). A more technical and far more complete exposition is given in Chomsky (1965).
2. For further discussion of the notions of observational and descriptive adequacy, cf. Chomsky (1964b).
3. My notation for transformations follows that of Rosenbaum (1965), except where otherwise noted.
4. The assumption that relative clauses are introduced in the deep structure by the rule $NP \rightarrow NP S$ will be justified in Lakoff and Ross (in preparation b).
5. Except Langacker's notion of command (Langacker (1966)) and Klima's notion in construction with (Klima (1964)), which will be discussed separately in §5 below, in connection with the notion of bounding.

Chapter 2

THE A-OVER-A PRINCIPLE

2.0. In a paper written for the 1962 Ninth International Congress of Linguists, "The logical basis of linguistic theory" (Chomsky (1964a)), on p. 930-931, while discussing the relative clause transformation and the question transformation, Chomsky makes the following statement:

"The same point can be illustrated by an example of a rather different sort. Consider the sentences:

- (6) (i) who(m) did Mary see walking toward the railroad station?
 (ii) do you know the boy who(m) Mary saw walking to the railroad station?

(7) Mary saw the boy walking toward the railroad station.

(7) is multiply ambiguous; in particular it can have either the syntactic analysis (8i) or (8ii)

- (8) (i) NP - Verb - NP - Complement
 (ii) NP - Verb - NP

where the second NP in (8ii) consists of a NP ("the boy") with a restrictive relative clause. The interpretation (8ii) is forced if we add "who was" after "boy" in (7); the interpretation (8i) is forced if we delete "ing" in (7). But (6i,6ii) are not subject to this ambiguity; the interpretation (8ii) is ruled out, in these cases. Once again, these are facts that a grammar would have to state to achieve descriptive adequacy. (Notice that there is a further ambiguity, where "Mary" is taken as the subject of "walk", but this is not relevant to the present discussion.)

The problem of explanatory adequacy is, again, that of finding a principled basis for the factually correct description. Consider how (6i) and (6ii)

must be generated in a transformational grammar for English. Each must be formed by transformation from a terminal string S underlying (7). In each case, a transformation applies to S which selects the second NP, moves it to the front of the string S, and replaces it by a wh-form.¹⁵ [I have not quoted footnote 15 here, for it does not bear on the A-over-A principle-JRR] But in the case of (7) with the structural description (8ii), this specification is ambiguous, since we must determine whether the second NP -- the one to be prefixed -- is "the boy" or "the boy walking to the railroad station," each of which is an NP. Since transformations must be unambiguous, this matter must be resolved in the general theory. The natural way to resolve it is by a general requirement that the dominating, rather than the dominated, element must always be selected in such a case. This general condition, when appropriately formalized, might then be proposed as a hypothetical linguistic universal. What it asserts is that if the phrase X of category A is embedded within a larger phrase ZXW which is also of category A, then no rule applying to the category A applies to X (but only to ZXW)."

It is the principle stated in this last sentence which I will refer to as the A-over-A principle. In terms of tree diagram (2.1), the principle asserts that all transformations which refer to A must apply to the topmost instance of A in (2.1), not the dominated A, which I have circled.

(2.1)

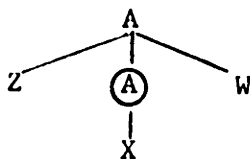

2.1. Chomsky, in the course of revising the paper quoted above for separate publication as the monograph Current Issues in Linguistic Theory (Chomsky 1964b), realized that the A-over-A principle was too strong. On page 46, in footnote 10, he gives the examples "who would you approve of my seeing?", "what are you uncertain about giving to John?", and "what would you be surprised by his reading?", where in each case the question word, who or what, itself an NP, has been moved out of another NP ([_{NP} my seeing something], [_{NP} giving something to John], [_{NP} his reading something])¹. Other examples of this sort are not difficult to construct, and there are even cases where the relative clause transformation can move either a dominated NP or any one of an unbounded number of NP's which dominate it.

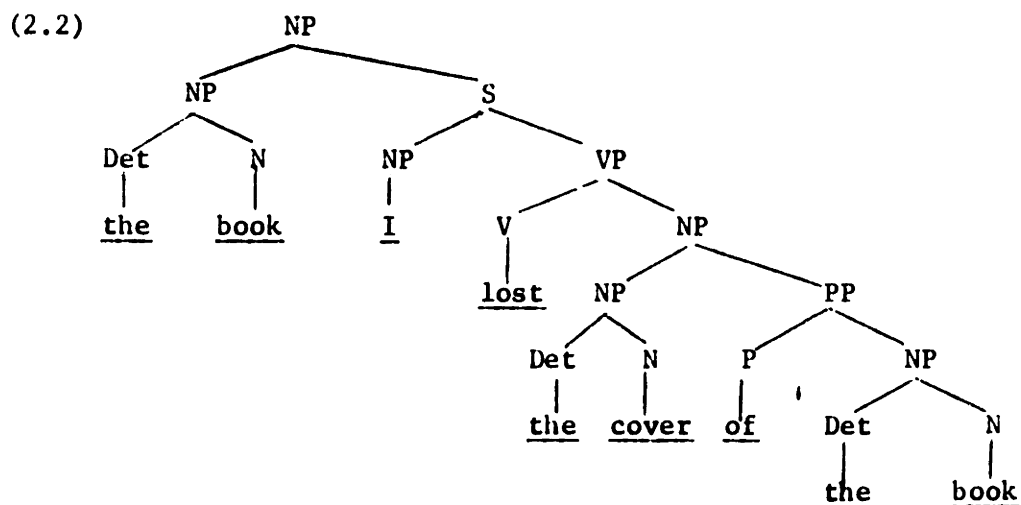

The relative clause rule², when applied to (2.2), will produce either the book, the cover of which I lost, or the book which I lost

the cover of, the second of which would be ruled out by the A-over-A principle. The example can be made more complicated by embedding the NP in ever larger NP's, and as far as I know, this process can be repeated without limit. Thus if the structure underlying (2.3)

(2.3) The government prescribes the height of the
lettering on the covers of the reports.

is embedded as a relative clause into an NP whose head noun is reports, the relative clause rule must produce (at least) four relative clauses: the reports, the height of the lettering on the covers of which the government prescribes; the reports, the lettering on the covers of which the government prescribes the height of; the reports, the covers of which the government prescribes the height of the lettering on; and the reports which the government prescribes the height of the lettering on the covers of. The problem of how to formulate the relative clause rule so that it will produce all four of these is an important and difficult one which I will discuss in some detail later (cf. §4.3 below); but for the purposes of the present discussion it is enough to note that the A-over-A principle would exclude all but the first of these four clauses. Many other examples of the same kind, which show that the principle as originally stated is too strong, can be found, so it would appear that it must either be modified somehow, or abandoned and replaced by some weaker principle. I have not been able to find any successful

modification, and therefore, I have pursued the latter course.

2.2. Of course, it was not merely to handle certain restrictions on question and relative clause formation that the A-over-A principle was proposed. And it is incumbent upon anyone who wishes to modify or replace this principle to take into consideration all cases which it dealt with satisfactorily. As far as I know, the following is a complete list of all cases which the principle handled convincingly. In all of these, I have been able to construct an alternative explanation which still allows the generation of such sentences as were demonstrated in § 2.1 to be improperly excluded by the A-over-A principle. In all of the cases but one, I will not present here the alternative I have found, but rather postpone the explanation until a more natural time in the sequence of exposition. For ease of reference, I will repeat here several examples which I have already discussed, so that all cases which seem to support the A-over-A principle are grouped together.

- A. Elements of relative clauses may not be questioned or relativized. Thus, the sentence I chased [the boy who threw [a snowball] at our teacher] can never be embedded as a relative clause in an NP whose head noun is snowball: sentence (2.4) is ungrammatical.

(2.4) * Here is the snowball which I chased the boy who threw at our teacher.

It is easy to see how the A-over-A principle would exclude this: in the source sentence the NP a snowball is embedded within a larger NP the boy who threw a snowball at our teacher, and the principle dictates that only dominating, not dominated, nodes can be affected by the operation of a rule.

This restriction also applies to elements of reduced relative clauses (i.e., those in which the initial which is has been deleted³): the NP bikinis is impossible to question or relativize in the following sentence: she reported [all the girls wearing NP [bikinis]] to the police. Thus the following question is impossible:

(2.5) * Which bikinis did she report all the girls wearing to the police?

B. Elements of sentences in apposition to such sentential nouns as fact, idea, doubt, question, etc., cannot be questioned or relativized.

Thus the sentence Tom mentioned [the fact that NP she had worn [a bikini.]] cannot be embedded as a relative clause into an NP whose head

noun is bikini: sentence (2.6) is ungrammatical:

(2.6) * Where's the bikini which Tom mentioned
the fact that Sue had worn?

Once again, it is easy to see how the A-over-A principle can be made use of in excluding this sentence.

- C. An extraposed clause may never be moved outside "The first sentence up," as was discussed briefly in § 1.0. Assuming that an approximately correct formulation of the rule for Extrapolation from NP is the one which was given in (1.10), which I repeat here for convenience,

(1.10) Extrapolation from NP

$$\begin{array}{ccccccc}
 X & - & [NP - S] & - & Y & & \\
 & & \underbrace{\hspace{1.5cm}} & & \text{NP} & & \text{OPT} \\
 & & 1 & & 2 & & 3 \\
 & & & & & & \Longrightarrow \\
 & & 1 & & 0 & & 3+2
 \end{array}$$

we see that unless it is somehow restricted, it will have two results when it is applied on the topmost cycle of the structure shown in (2.7).

(2.7)

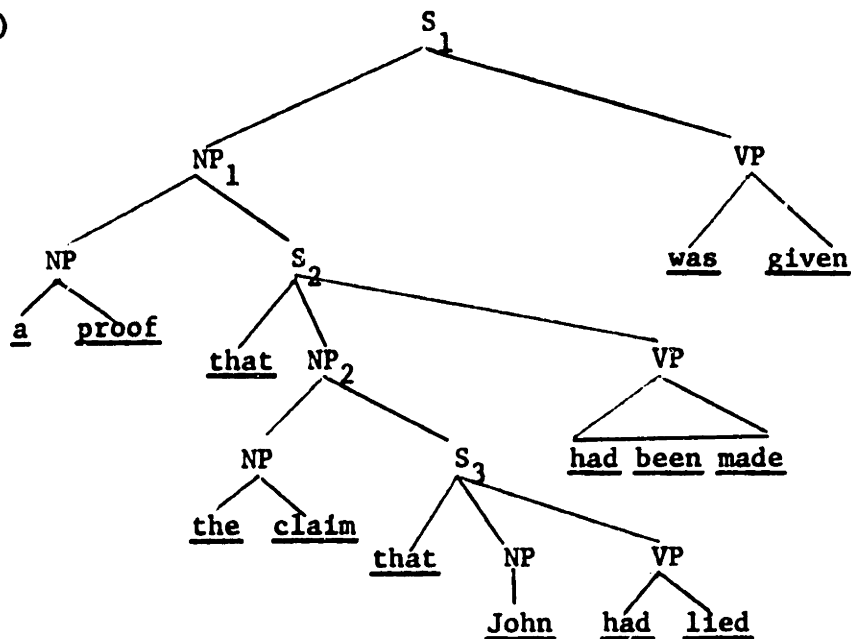

Either S₂ (the subscripts have no systematic significance and are merely inserted as an aid to exposition) could be moved to the end of S₁, which would yield the grammatical sentence (2.8),

(2.8) A proof was given that the claim that
John had lied had been made.

or S₃ could be moved to the end of S₁, which would result in the ungrammatical (2.9),

(2.9) * A proof that the claim had been made was
given that John had lied.

Sentences like (2.9) could be avoided if the A-over-A principle was strengthened somewhat so that if a P-Marker had two proper analyses with respect to

the structural index of some transformation⁴, where one proper analysis "dominated" the other, in a sense which is intuitively fairly clear, but would probably be difficult to state formally, then the transformation in question would only perform the operations specified in its structural change⁵ with respect to the "dominating" proper analysis. Begging the question of how these notions could be made precise, it should be clear that the sequence of nodes $[\text{NP } \text{S}]_{\text{NP}}$ which is immediately dominated by NP_1 in (2.7) "dominates", in the intended sense, the sequence of nodes $[\text{NP } \text{S}]_{\text{NP}}$ which is immediately dominated by NP_2 ; so Extrapolation from NP could not produce (2.9) from (2.7), if the strengthened version of the A-over-A principle which was sketched immediately above were adopted.

- D. In a relative clause structure, $\begin{array}{c} \text{NP} \\ \swarrow \quad \searrow \\ \text{NP}' \quad \text{S} \end{array}$, it is not possible to question or relativize the dominated NP' . This is the case discussed by Chomsky in the passage quoted in § 2.0 above. An example of the kind of sentence that must be excluded is the following: it is not possible to question (2.10) by moving

someone to the front of the sentence and leaving the relative clause who I was acquainted with behind.

(2.10) He expected [[someone]_{NP} who I was acquainted with]_{NP} to show up.

Thus (2.11) is ungrammatical:

(2.11) * Who did he expect who I was acquainted with to show up?

In (2.10), if the NP someone is to be questioned, the whole NP which dominates it, someone who I was acquainted with, must be moved forward with it, yielding (2.12), or, by later extraposition, (2.13)

(2.12) Who who I was acquainted with did he expect to show up?

(2.13) Who did he expect to show up who I was acquainted with?

It should be obvious how the A-over-A principle would exclude (2.11).

E. A NP which is exhaustively dominated⁶ by a Determiner cannot be questioned or relativized out of the NP which immediately dominates that Determiner. Thus, from (2.14) it is impossible to form (2.15):

(2.14)

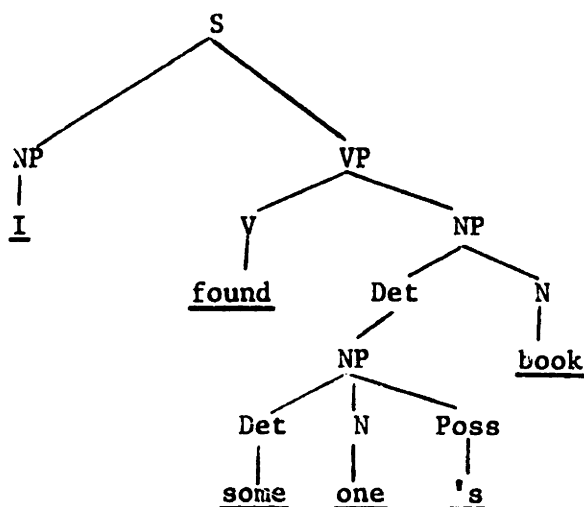

(2.15) * Whose did you find book?

Only (2.16) is possible:

(2.16) Whose book did you find?

and the A-over-A principle correctly makes this assertion.

F. An NP which is a conjunct in a coordinate NP structure cannot be questioned or relativized. Thus, in (2.17), neither of the conjoined NP's may be questioned -- (2.18) and (2.19) are both impossible.

(2.17) He will put the chair between $_{NP}$ $_{NP}$ [some table] $_{NP}$ and [some sofa] $_{NP}$.

(2.18) * What sofa will he put the chair between some table and?

(2.19) * What table will he put the chair between and some sofa?

Once again, the A-over-A principle will exclude these last two sentences.

- G. The last example was suggested by James McCawley (cf. McCawley (1964)). He points out that if the Adjective Shift Rule, the rule which permutes a reduced relative clause with the noun it modifies, if the clause is only a single adjective, and not a phrase, is formulated as in (2.20),

(2.20)	X	N	Adj	Y	
	1	2	3	4	⇒
	1	3	2	0	4

Then it is necessary to invoke the A-over-A principle; for otherwise, when which is has been deleted from (2.21), the adjective big will permute with the noun case, instead of with the whole compound noun book case.

(2.21)

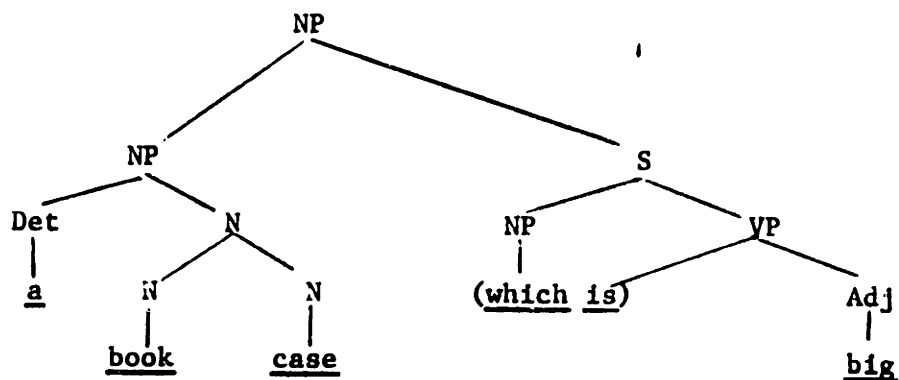

Thus, without the stronger version of the A-over-A principle which was discussed above in connection with Extrapolation from NP, rule (2.20), when applied to (2.21) would yield the incorrect * a book big case instead of the desired a big book case.

2.3. As was stated above, I have been able to find alternative explanations for all seven of the cases discussed in § 2.2 above. Cases A, B, and C will be accounted for by the Complex NP Constraint, which will be discussed below, in § 4.1. In case D, ungrammatical sentences like (2.11) will be shown to be excluded by either of two independent conditions: the Complex NP Constraint of § 4.1, or the Pied Piping Convention, which will be discussed in § 4.3, in connection with relative clauses. The Pied Piping Convention will also be used to exclude the ungrammatical sentences which arose in case E. And case F will be accounted for by a special condition of great generality which will be discussed in § 4.2 -- the Coordinate Structure Constraint.

Case G remains to be explained without invoking the A-over-A principle, and it seems to me that the most likely line of explanation lies in rejecting the assumption that the correct statement of the Adjective Shift Rule is the one given above in (2.20). The rule of (2.20) must have many restrictions placed on it,

Chomsky at no time claims that these two conditions will have the same coverage as the principle, but since the facts given in cases A through F have to be accounted for anyway, it is of interest to see how far his two conditions can go towards this end.

In the quote that follows, '(6)' refers to the following rule, which Chomsky states on p. 38, and which he asserts is the basic rule in question and relative clause formation.

$$(6) \quad Y - \underline{Wh} + X - Z \implies \underline{Wh} + X - Y - Z$$

2.4.1. The first of the proposed conditions on this rule is on pp. 43-44:

"Notice that although several noun Phrases in a sentence may have Wh attached to them, the operation (6) must be limited to a single application to each underlying terminal string. Thus we can have 'who saw what?', 'you met the man who saw what?', 'you read the book that who saw?', 'you saw the book that was next to what?', etc., but not 'who what saw?', 'you saw the book which which was next to' (as a declarative), and so on, as could arise from multiple applications of this rule. These examples show that (6) cannot apply twice to a given string as a Relativization and cannot apply twice as an Interrogative transformation, but it is equally true that it cannot apply to a given string once as a Relativization and once as an Interrogative transformation. Thus if rule (6) has applied to form a string which is embedded as a relative clause, it cannot reapply to this embedded string, preposing one of its Noun Phrases to the full sentence. Thus we can have the interrogative 'he saw the man read the book that was on what?', but not 'what did he see the man read the book that was on'; and we can have 'he wondered where John put what?', but not 'what did he wonder where John put'; etc."

My first objection to this condition, which I will refer to as Condition 1, is that it seems to me to be somewhat too strong. That is, I find the sentences in (2.23) all more or less acceptable:

- (2.23) a. He told me about a book which I can't
figure out { whether to buy or not }
 { how to read. }
 { where to obtain. }
 { what to do about. }
- b. He told me about a book which I can't
figure out { why he read. }
 { ?whether I should read }
 { ??when I should read. }
- c. Which books did he tell you { why }
 { ?whether }
 { ??when }
he wanted to read?

For some reason that is obscure to me, I find sentences like those in (2.23a), where the embedded question⁸ consists of a wh-word followed by an infinitive, by and large more acceptable than corresponding sentences, like those in (2.23b), where the wh-word is followed by a clause with a finite verb. And yet there are many sentences which differ in no way which I can discern from those in (2.23b-c) but which I find totally unacceptable. (Chomsky's example, "* what did he wonder where John put?" is a good case in point). So, for speakers who agree with me in finding at least some sentences like those in (2.23) acceptable, Condition 1 is too strong as it stands, although examples like Chomsky's make it clear that it is partially true. This all indicates that much more work needs to be done on this condition, so that a weaker version of it may be found.

It is apparent that even a correct version of Condition 1 must be supplemented somehow by other principles; for, of the six cases which were discussed in § 2.2, Condition 1 can only account for case A. And it should be noted that even in case A, it is not obvious how Condition 1 should be stated so that it will apply to embedded questions, full relative clauses, and reduced relative clauses. That is, in (2.24a) and (2.24b), it is easy to state formally that, in Chomsky's terms, "operation (6)" has applied once, for there is a substring which is headed by a wh-word.

(2.24) a. I know who is mad at John.

b. I know a boy who is mad at John.

But in (2.25), which has been derived from (2.24b) through the operation of the Relative Clause Reduction Rule, there is no longer any wh-word in the sentence which could be used as an indication that Condition 1 must be invoked.

(2.25) I know a boy mad at John.

The fact that NP's in the position of John in (2.25) cannot be relativized or questioned (cf. the ungrammaticality of * who do you know a boy mad at?) would have to be stated in some other way than in terms of wh-words, possibly, for instance, as follows:

(2.26) No element of a constituent of an NP which modifies the head noun may be questioned or relativized.

But this condition is strong enough to account for cases A and (with

suitable modification) B, of § 2.2; and in fact, condition (2.26), when suitably formalized, is the cornerstone of what I have called the Complex NP Constraint, and will be discussed in detail in § 4.1.

It appears, therefore, that Condition 1 is of limited utility, except insofar as it can be given in a weakened reformulation which will allow some of the sentences in (2.23) to be generated, but will exclude others, like Chomsky's example of "* what did he wonder where John put?". I should add that none of the conditions I will propose in Chapters 4 or 5 can be modified, in any way that I know of, to exclude this last example; so it is evident that some version of Condition 1 must appear in the grammar of English, or, if this condition should prove to be universal, in linguistic theory.

2.4.2. The second condition which Chomsky proposes for his rule, (6), is stated as follows:

"Finally, it is clear that the first segment Y of the structural condition of rule (6) must be suitably restricted. Thus we cannot have such interrogatives as 'what presumably did Bill see' from 'presumably Bill saw something', and so on. This suggests that we restrict Y in (6) to the form NP + With this further condition, we also succeed in excluding such non-sentences as 'what for me to understand would be difficult?', although the perfectly correct form 'what would it be difficult for me to understand?' is still permitted. Thus this condition would account for a distinction between the occurrences of 'for me to understand something' in the contexts '---- would be difficult' and 'it would be difficult ----',

so far as applicability of (6) is concerned.^{10,}
 (op. cit. pp. 45-46) [I do not quote footnote
 10 here, because its content has been discussed
 in § 2.1 above, and it is of no direct relevance
 to the point at hand -- JRR].

This condition, which I will refer to as "Condition 2",
 bears close scrutiny, even though it is clear that there is no overlap
 at all between it and the A-over-A principle -- none of the ungrammatical
 sentences discussed in cases A through F of § 2.2 will be
 excluded by Condition 2.

In the first place, the first example is not convincing.
 The fact that Chomsky's example * what presumably did Bill see? is
 ungrammatical has nothing to do with the fact that an adverb starts
 the sentence; as was noted in footnote 8 above, questions are
 incompatible with sentence adverbs in any position. Thus, neither
 in Bill presumably saw something nor in Bill saw something, presumably
 can the word something be questioned: * what did Bill presumably see?
 and * what did Bill see, presumably? are both probably to be
 excluded. It may be that Condition 2 is correct anyway, but if it
 is, all of the sentences in (2.27), (2.28), and (2.29) must be
 explained away, for they appear to be counterexamples.

(2.27) After maintaining that you were sick, why did
 you get out of bed?

Although you've never been in one, what would
 you do in a typhoon?

In light of this promotion, how long will you

stay here?

Furthermore, what prompted you to hit John?

If it rains, will you finally give up and go home?

(2.28) Why, after maintaining that you were sick, did you get out of bed?

What, although you've never been in one, would you do in a typhoon?

How long, in light of this promotion, will you stay here?

What, furthermore, prompted you to hit John?

What, presumably, did Bill see?

(2.29) $\left\{ \begin{array}{l} \text{And} \\ \text{But} \\ \text{For} \end{array} \right\}$ what can you do with the wounded?

The type of explanation which at first seems attractive is one involving rule ordering. That is, one might suggest that the Question Rule should apply first, and that then the adverbial elements which start the sentences in (2.27) should be moved to the front of the sentence, past the wh-words, to yield the sentences in (2.27). Subsequently, a second adverb movement rule might move the preposed adverbs to the position immediately following the wh-word, and insert pause markers on either side of them. To give an example, the second sentence in (2.27) and (2.28) would be derived as follows:

Base: you would do wh + something in a typhoon, although you've never been in one.



question formation

what would you do in a typhoon, although you've never been in one?



1st adverb movement

(2.27) Although you've never been in one, what would you do in a typhoon?



2nd adverb movement

(2.28) What, although you've never been in one, would you do in a typhoon?

Note that if this proposal is adopted, Condition 2 can be dispensed with anyway, for at the time at which the question rule applies, no adverbs have yet been moved into sentence-initial position. But there is still some doubt in my mind as to whether the rule-ordering explanation is possible, because the sentences of (2.30) have such low acceptability that I doubt they should be generated at all.⁹

(2.30) a. ? I wonder, after maintaining that you were sick, why you got out of bed.

- b. ? Tom will ask you, although you've never been in one, what you would do in a typhoon.
- c. ?*I wonder, if it rains, whether he will finally give up and go home.
- d. *It is not known, if it rains, whether he will finally give up and go home.
- e. *She raised the question $\left\{ \begin{array}{l} \text{as to} \\ \text{of} \end{array} \right\}$, if it rains, whether he will finally give up and go home.

Since the sentences in (2.30) all contain embedded questions, the first adverb movement rule, which produces the sentences of (2.27), will also generate the ones in (2.30), unless it can be restricted somehow, which seems doubtful to me. And if the first adverb movement rule cannot be prevented from generating them, then the second adverb movement rule, which converts sentences like those in (2.27) to ones like those in (2.28), must somehow be made obligatory when it operates on embedded questions. It does not appear to me as if conditions of either of these kinds on the adverb movement rules cannot be stated, but it does begin to seem that the rule-ordering mode of explanation may not be the optimal one.

If the correct explanation is not to be found in the ordering of the rules, then some version of Condition 2 may be necessary. I say "some version", because it seems to me that the sentences in (2.29) constitute clear (though rather trivial) counterexamples

to the condition as it was originally stated.

I would like to call particular attention to the last sentence of (2.28), what, presumably, did Bill see? This sentence seems perfectly acceptable, as long as heavy pauses separate presumably from the rest of the sentence. This fact is especially baffling, since it seems that presumably can occur nowhere else in the questioned sentence, unless I was wrong in excluding the question which has it occurring finally, preceded by a comma: ?* what did Bill see, presumably? It is obvious that much more work will have to be done in this area before answers to many of the questions I have raised can be attempted.

One last comment about Condition 2 should be made: although it is strong enough to exclude Chomsky's example, * what for me to understand would be difficult?, I will show below in § 4.4 that sentences like this can be excluded by a much more widely applicable condition than Condition 2, and one that is independently motivated. So it appears that although Condition 2 may be correct, the only support for it is to be found in the confused mass of cases which have to do with the interrelationship of the two adverb movement rules and the question formation rule.

2.5. In summary, I have tried to demonstrate in this chapter that the three conditions on the relative clause and question formation

rule which Chomsky has proposed all suffer from defects of various kinds. The A-over-A principle, while shown in § 2.1 to be too strong in a non-trivial way, still is the most important of the three, because of the wide range of cases it successfully accounts for. Condition 1 seems to be somewhat too strong, in some way which I cannot yet delimit precisely; but insofar as it is correct in the restrictions it imposes upon the relativizing or questioning of elements in embedded questions, it is valuable and should be added either to the rules of English grammar or to the theory of grammar. But it seems that this condition, if it is to apply both to full and to reduced relative clauses, cannot be formulated in terms of Chomsky's notion of "single application of rule (6) to a string"; rather, it must be formulated along the lines suggested in (2.26), and, as will be shown in § 4.1, (2.26) contains, in rough form, the central notion of the Complex NP Constraint, which has much independent motivation. In any case, Condition 1 fails to account for most of the six cases of § 2.2. The status of Condition 2 is undecided, because of the present lack of knowledge about the complex syntactic phenomena which may provide support for it. But whether it is eventually adopted or not, it can account for none¹ of the six cases of § 2.2.

I hope that in my criticisms of the three conditions proposed by Chomsky I have not given the impression that I wish to belittle them, merely because they can be proven to be wrong today;

for the contrary is true: these conditions, in particular the A-over-A principle, provide the basis for the present work. For as Chomsky remarked,

"Precisely constructed models for linguistic structure can play an important role, both negative and positive, in the process of discovery itself. By pushing a precise but inadequate formulation to an unacceptable conclusion, we can often expose the exact source of this inadequacy and, consequently, gain a deeper understanding of the linguistic data."
(Chomsky (1957), p.5)

The main task of this work is to provide a set of constraints which will avoid the defects pointed out in § 2.1 and will account for all the cases in § 2.2. Before this can be attempted, in Chapter 4, one digression must intervene: Chapter 3, in which the notion of tree-pruning, which interacts in various ways with the constraints of Chapters 4 and 5, is discussed.

Chapter 2

FOOTNOTES

1. For a justification of the assignment of NP status to these embedded sentences, cf. Rosenbaum (1965).
2. For justification for the claim that the rule $NP \rightarrow NP S$ is the correct deep structure of relative clauses, a claim which is implicit in Chomsky's earlier discussion of relative clauses (cf. Chomsky (1964a), p. 930 bottom, and p. 933 top), cf. Lakoff and Ross (in preparation b).
3. For a discussion of the relative clause reduction rule, cf. Smith (1961).
4. The most complete discussion of the notions P-Marker, proper analysis and structural index is contained in Chomsky (1955). A shorter account is given in Fraser (1963).
5. For an explanation of the term "structural change" cf. the references of fn. 4, or Chomsky (1957), or Lees (1960).

6. The relation exhaustively dominates is the converse of the converse of the ISA relation (cf. Fraser (1963)). I use the term (weakly) dominate as follows: if A (weakly) dominates B, then A exhaustively dominates XBY, where X and Y are (possible null) variables and B is a single symbol or a string of symbols. A immediately dominates B if and only if A dominates B and there is no Z such that A dominates Z and Z dominates B.
7. Sentences like I painted red all the houses which had white doors are derived by a different rule which moves "complex" NP (for an attempted partial explanation of this term, cf. § 3.1.1.3.2. below) to the end of the first S above them. Some results of this rule are the sentences I would consider unwise any attempt to visit her now, Pete attributed to Masaccio a beautiful old fresco which Joan swooned over, They elected president a man who had never run for public office before, etc.
8. There are two facts about such sentences as those in (2.23) which indicate that the clauses in them that start with a wh-word are in fact questions, and not the type of clause which has been called "the free relative clause," such as the wh-word clauses in I eat what she cooks or I live where he lives.

1. Questions exclude sentence adverbs, like perhaps, probably, possibly, etc., as was pointed out by Katz and Postal (cf. Katz and Postal (1964), p. 87-88).

Thus the following sentences are impossible:

* Did John probably hurt himself?

* What will she perhaps wear?

* Where did you possibly find this?

The same restriction, however it is to be stated, which is far from being clear, obtains after such verbs as ask and wonder,

* I wonder whether to probably leave.

* Tom asked where he should possibly put the car.

although after ask there are contexts where these adverbs can occur; e.g., Tom asked where Jane probably put the car. There is still much to be explained here.

2. The word else can appear after the wh-word in questions

What else did he say?

Where else did you stop?

Why else would he have come?

and after the wh-word in clauses after wonder, ask, know, find out, determine, guess, etc.

I wonder what else he said.

Tom asked where else I stopped.

? I know why else he would have come.

but it cannot appear after the wh-word of a free
relative clause

* I ate what else she cooked.

* I live where else he lives.

9. I will occasionally wish to designate more than two degrees of acceptability; when I do so I assert that I find that sentences prefixed with an asterisk are completely unacceptable; those prefixed with a question mark followed by an asterisk are only barely acceptable, if at all; those prefixed with a question mark are not quite fully acceptable; and those with no prefix are completely acceptable.

Chapter 3

TREE PRUNING¹

3.0.

3.0.0. A fairly serious failing of the present theory of generative grammar is that it assigns to many sentences derived constituent structures which seem intuitively to be overly complex. For instance, sentence (3.1) would probably be assigned some such structure as the one given in (3.2):

(3.1) John is taller than Bill.

(3.2)

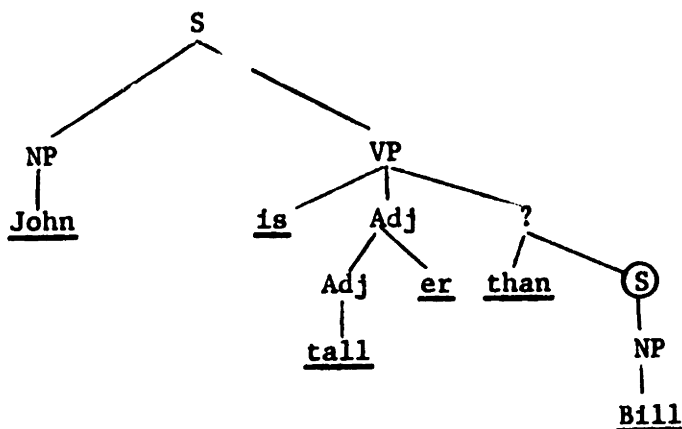

At present, I am not interested in the question of what the node over the constituent than Bill (if indeed it is a constituent at all) should be labeled, so I have avoided the issue by labeling it with a question mark. What concerns me at present is only the question of whether the NP Bill should be immediately

dominated by the circled node S. It seems intuitively abhorrent to assert that, in sentence (3.1), the single word Bill has the same status as a constituent as the whole sentence, and yet that is precisely the assertion that the labeled bracketing in (3.2) makes. And yet in sentence (3.3), from which (3.1) is derived by the deletion of the second occurrence of the word is, it seems more reasonable that the phrase Bill is should be called a sentence,

(3.3) John is taller than Bill is.

for there is every reason to believe that the underlying structure contained the sentence Bill is tall. Transformational grammarians since Harris (cf. Harris (1957), p. 166) have agreed that sentences containing comparatives derive from sources containing at least two sentences, and in more complex comparative sentences, like those in (3.4)

(3.4) This sofa is longer than the room is wide.

Tom is smarter than anyone thought he would
prove himself to be.

Bannister ran a little faster than it was
necessary for him to run.

there is no intuitive difficulty in labeling as sentences the phrases which follow than. But the phrase Bill is, in (3.3), which it seems correct to call a sentence, ceases to be felt to be one when the word is is deleted.

Similarly, it seems counter-intuitive to claim, with the present theory, that the correct structure to assign to a NP like his yellow cat is one roughly like the one shown in (3.5).

(3.5)

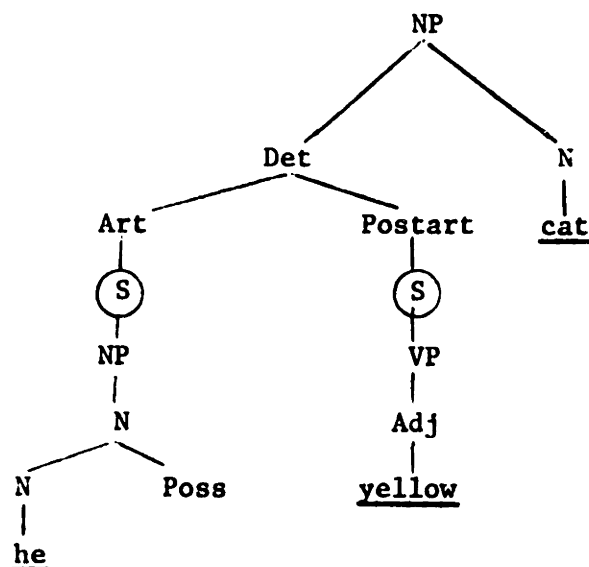

Once again, recent research in syntax has called into question many facets of the analysis implicit in (3.5) (cf. Postal (1966a) and Lakoff and Ross (in preparation b)), but at present I am only interested in the fact that it seems incorrect to claim that the words his and yellow are sentences.² In the present theory, an NP like the one diagrammed in (3.5) would, correctly I think, be derived from an underlying NP with two relative clauses: the cat which I have which is yellow. The motivation for deriving possessives and prenominal adjectives from relative clauses is well-known enough not to need recapitulation here

(cf., e.g., Harris (1957)), although several real problems remain (cf. Winter (1965)). But it seems to me that the analysis is well-established enough to make the appearance of the two circled S nodes in (3.5) more than a pseudo-problem.

3.0.1. To overcome the inadequacies of the present theory, which I have just discussed, I propose that the following principle be added to the theory of derived constituent structure:

- (3.6) S - Pruning: delete any embedded node S which does not branch (i.e., which does not immediately dominate at least two nodes).

This principle should not be thought of as a rule which is stated as one of the ordered rules of any grammar, but rather as a condition upon the well-formedness of trees, which is stated once in linguistic theory, and applies to delete any non-branching S nodes which occur in any derivations of sentences of any language. The condition that (3.6) only affect embedded S nodes, which was suggested to me by George Lakoff, is necessary to prevent the node S which should dominate imperative sentences like go home! from deleting when the subject, you, is deleted.³

It is easy to see that (3.6) will operate on the circled instances of the node S which were pointed out to be intuitively incorrect in diagrams (3.2) and (3.5), but the only evidence I have given so far for adopting (3.6) is that without

it, counter-intuitive derived structures would be produced. This is already a sufficient reason for incorporating (3.6) or something like it into the theory, but it might be objected that (3.6) could be replaced by some other convention which would do as well for the two cases I have discussed. Below, however, in § 3.1, I will discuss eight cases which I know of, whose correct analysis seems to me to depend upon occurrences of S being pruned out either by the principle stated in (3.6) or by some more general principle which subsumes it. These cases constitute even stronger evidence for (3.6), for in each case the rules which would be required in order to describe the facts accurately without the principle are far more complex than the rules which can be formulated if the principle is adopted. In most cases, ad hoc conditions would have to be placed upon the latter rules, but in some cases extra rules would have to be added, and in one case, which is discussed in § 3.1.4, the facts seem to me to resist description completely, unless one allows the Complex NP Constraint (cf. § 4.1), which is applicable elsewhere in English and which I believe to be universal, to be avoided somehow for just these cases.

3.0.2. Before I start in on a detailed analysis of the eight cases, I would like to add one final prefatory comment, which was suggested to me by James Thorne, in a recent letter. Traditional

grammarians distinguished between phrases and clauses; and while a considerable effort has been made, both in structuralist linguistics and in generative grammar, to reconstruct the former notion (the resulting theoretical entities have been called (immediate) constituents, tagmemes, or trees), little attention has been focussed on the latter notion, to the best of my knowledge, in any recent theoretical work. In the framework of generative grammar, it would seem that the most natural reconstruction for the traditional notion of clause of a sentence would be "any subpart (not necessarily proper) of the terminal string of the final derived phrase marker of a sentence which is dominated by the node S." But without some notion of tree-pruning, the cases discussed above, (3.2) and (3.5), are counter-examples to this reconstruction, for no traditional grammarian would designate as clauses the words Bill, his, or yellow. However, with principle (3.6), these words are no longer dominated by S in the derived phrase marker, so the definition just proposed is again in line with the traditional notion. It might be thought that the distinction between clause and phrase is a minor one, but I feel that the contrary is the case. Many rules can only be stated if the notion of clause is available (three of these -- the Latin word order rule, the Serbo-Croatian clitic placement rule, and the English reflexive rule -- will be discussed in the next section), and I think it

is fair to say that the fundamental idea of transformational grammar -- Harris's insight that complex sentences can be thought of as being in some way "composed" of more elementary sentences, which may only appear in a deformed shape in the complex sentence -- can be traced back to the realization that what might be called "clauses of the underlying structure" may differ from the things which have traditionally been called simply "clauses," but which it might be more accurate to call "clauses of the superficial structure." And the failure of traditional grammarians to recognize that the clauses I go and I shave myself underlie the phrases to go and shaving myself in (3.7)

(3.7) I want to go.

Shaving myself is difficult for me.

may derive in part from the fact that such principles as (3.6) were not available to them.

3.1.

3.1.1.

3.1.1.1. The first of the eight cases I will discuss has to do with the interaction of the Particle Movement Rule and "complex" NP. Verb particles in English are a subset of the English prepositions which occur in such two-word idiomatic verbs as eke out, think over, call up, show off, etc.⁴ Since there is a

close lexical connection between verb and particle (bruit, for instance, only occurs in English in construction with the particle about), in previous transformational accounts it has been assumed that the structure underlying (3.8a) is basic and that (3.8b) is derived from it by a rule roughly like the one given in (3.9) (cf. Chomsky (1962), p. 228).

(3.8) a. The shock touched off the explosion.

(3.8) b. The shock touched the explosion off.

(3.9) Particle Movement

X	V	-	Prt	-	NP	-	Y	
1			2		3		4	\Rightarrow OPT OBLIG if 3 is a pronoun BLOCKS if 3 is "complex"
1			0		3+2		4	

The condition that (3.9) be obligatory if the object NP is a pronoun has been imposed in order to exclude sentences like *I called up him. But it is the second condition on (3.9) which I am primarily interested in, in connection with the problem of node deletion. Chomsky notes (cf. Chomsky (1961), fn. 13) That whatever "complex" in the second condition on (3.9) may mean, it cannot be equated with "long", for he finds (3.10a), though far longer, far more acceptable than (3.10b).

(3.10) a. I called almost all of the men from
Boston up.

b. * I called the man you met up.

I agree with his intuitions, but I must point out that there are people who find (3.10b) perfectly acceptable, and there may even be people who find it better than (3.10a). The whole problem area of what NP are felt to be "heavy" or "complex" borders on questions of style, and there seems to be a baffling array of dialectal, or possibly even idiolectal, variations here. Since I have not made a systematic study of this variation, I can have no hope of finding examples whose acceptability will be agreed on by all readers, if indeed such examples exist. Instead I must resort to describing the facts of my own speech, insofar as they can be ascertained with any consistency, for this area is really a grammatical shadowland, and I fear my own judgments may change from time to time. I can only hope that most readers will share my judgments, at least in part.

3.1.1.2. With this caveat, I would like to propose the following definition as a partial explication of the notion of "complex" NP.

(3.11) A noun phrase is complex if it dominates the
the node S.

Used in conjunction with the principle for S-pruning, (3.6), definition (3.11) explains why sentence (3.10b) is less acceptable than sentence (3.10a): in the d.c.s. of the former, the node S will dominate the relative clause you met, so the object NP,

the man you met, is complex, under definition (3.11); but in (3.10a), although the post-nominal modifier from Boston is derived from a relative clause, who are from Boston, the node S which dominates this clause in the deep structure will have been pruned by (3.6) when the Relative Clause Reduction Rule⁵ deletes the subject NP who and the copula are.

A similar explanation holds for the sentences in (3.12), (3.13), and (3.14). The b version of each of these sentences is more acceptable, because the nodes S which dominate the relative clauses of the a versions are deleted after the who is has been dropped by the Relative Clause Reduction Rule

- (3.12) a. * I ran a man who was old down.
 b. I ran an old man down.
- (3.13) a. * I'm going to call somebody who is strong up.
 b. ? I'm going to call somebody strong up.
- (3.14) a. * I polished the vase which was from India up.
 b. ? I polished the vase from India up.

I find sentences (3.13b) and (3.14b) somewhat worse than (3.12b), although none of them are complex according to definition (3.11). It is thus clear that (3.11) cannot be strengthened to a biconditional: for an NP to dominate the node S is a sufficient, but not a necessary, condition for diminished acceptability. A

possible explanation for the less than full acceptability of (3.13b) and (3.14b) will be suggested below, in § 3.1.1.3. Nevertheless, despite the fact that principle (3.6) cannot explain the variations in acceptability among the b sentences, the fact that it and definition (3.11) can predict the difference between the a sentences and the b sentences is an indication of the correctness of (3.6).

3.1.1.3.

3.1.1.3.1. I will now discuss what I consider to be an inadequacy of the previous analysis of particles, or of any analysis which includes conditions like those on (3.9). The second condition on (3.9), it will be remembered, was one which prohibited Particle Movement from moving a particle over a complex NP. I wish to argue that to state this as a condition on Particle Movement alone is to miss a very general fact about complex NP in English. In sentences (3.15) to (3.19) below, the a-sentences, in which the direct object immediately follows the verb, are basic, as is demonstrated by the acceptability of the b-sentences, in which the direct object has been moved to the end of the verb phrase.

- (3.15) a. He attributed the fire to a short circuit.
 b. *He attributed to a short circuit the fire.
 c. He attributed to a short circuit the fire which destroyed most of my factory.

- (3.16) a. He threw the letter into the wastebasket.
 b. * He threw into the wastebasket the letter.
 c. He threw into the wastebasket the letter
 which he had not decoded.
- (3.17) a. We elected my father president.
 b. * We elected president my father.
 c. We elected president my father, who had
 just turned 60.
- (3.18) a. They dismissed the proposal as too costly.
 b. * They dismissed as too costly the proposal.
 c. They dismissed as too costly the proposal
 for the State to build a sidewalk from
 Dartmouth to Smith.
- (3.19) a. I consider the problem unsolvable.
 b. * I consider unsolvable the problem.
 c. I consider unsolvable the problem of
 keeping the house warm in winter.

The grammaticality of the c-sentences can be explained by a rule which optionally moves a complex NP to the end of the first sentence up. As the non-sentences in (3.20) show, however, this rule must be restricted in some way,

- (3.20) a. * I $\left. \begin{array}{l} \text{forced} \\ \text{wanted} \end{array} \right\}$ to eat hot soup all the children
 who were swimming.

- b. * I told that we were in trouble a man
who had a kind face.
- c. * I watched talk(ing) all the children who
had never seen the sea.
- d. * He restrained from attempting to bend the
bars a cellmate he had knowⁿ on the outside.

for all of them are the result of moving a complex NP to the end of the S which contains it. It might be proposed that the rule should be restricted so that a complex NP can move to the end of its S only if it does not pass over a VP in moving there. Such a condition would be sufficient to exclude the ungrammatical examples in (3.20), but unfortunately it would also exclude (3.18c) and (3.19c), since I see no reason why the phrases too costly and unsolvable should not be considered to be verb phrases. Furthermore, the sentences in (3.21), which show that one complex NP can be moved over another, provide additional evidence against the proposed condition, for the second complex NP, over which the one being moved permutes, will of course contain a VP. (I have underlined these VP's in (3.21).)

- (3.21) a. He attributed to a short circuit which
was caused by an overloaded transducer
the fire which destroyed most of my factory.
- b. He threw into the wastebasket which stood
by his desk a letter which he had not
decoded.

- c. They dismissed as too costly to people who live in the suburbs the proposal for the State to build a sidewalk from Dartmouth to Smith.

Clearly the condition must be weakened somewhat, but before this is attempted, one further class of constructions must be taken into consideration.

- (3.22) a. ?* I found to be delicious some fruit which I picked up on the way home.
- b. I found delicious some fruit which I picked up on the way home.
- (3.23) a. ?* The mayor regarded as being absurd the proposal to build a sidewalk from Dartmouth to Smith.
- b. The mayor regarded as absurd the proposal to build a sidewalk from Dartmouth to Smith.
- (3.24) a. * I consider to be a fool the senator who made the opening speech.
- b. ? I consider a fool the senator who made the opening speech.

For me, at least, the a-sentences above are considerably worse than the b-sentences, although some speakers may find the distinction not to be as clearcut as I have indicated. This then

indicates that the rule which moves complex NP must be made sensitive to the presence of the copula, be, for the a and b-sentences above differ only in that be appears in the ungrammatical ones and does not appear in the ones which are grammatical. Under previous generative analyses of adjectives, such as the one found in Chomsky (1965), on p. 102, in which be is not treated as a verb, but rather as a terminal element of the base component, no simple statement of the restriction on the complex NP rule is possible, as far as I can see. However, under a new analysis of adjectives, which I have proposed in some detail elsewhere (cf. Ross (1966c)), the restriction is easily stated. In this new analysis, which is independently motivated by a number of constructions, be is treated as a real verb which takes a sentential object. Using the feature [+Adj]⁶, the underlying structure of John is happy is as shown in (3.25).

(3.25)

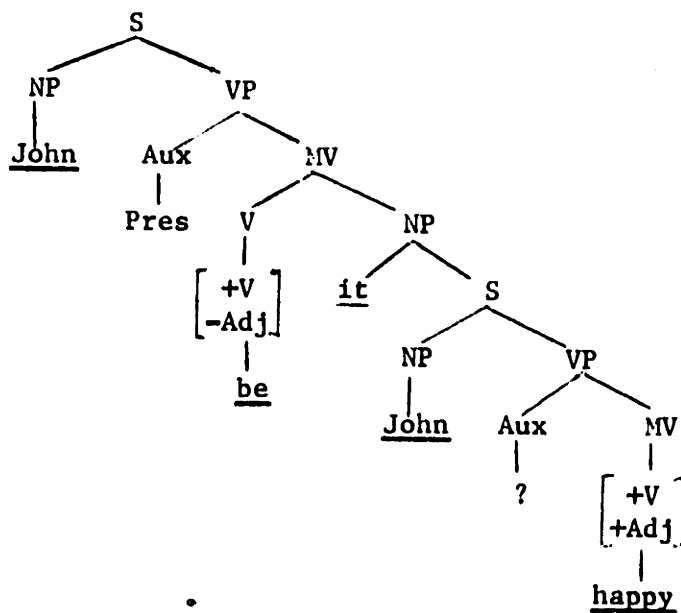

(I have used a question mark for the auxiliary of the embedded sentence to indicate my uncertainty as to whether it should appear at all there, and if so what node it should dominate)

Under the analysis which is implicit in (3.25), the restriction which is necessary to exclude the sentences in (3.20), (3.22a), (3.23a), and (3.24a), while allowing (3.18c), (3.19c), (3.21) (3.22b), (3.23b), and (3.24b), can be stated as follows: a complex NP may permute to the end of the first sentence up, providing it permutes over no true verb (i.e., $\begin{bmatrix} +V \\ -Adj \end{bmatrix}_1$), unless that verb is dominated by an NP. More formally, the rule is

(3.26) Complex NP Shift

X	-	NP	-	Y	
1		2		3	OPT ⇒
1		0		3 + 2	

Condition 1: 2 dominates S

2: BLOCKS if $3 = X_1 + \begin{bmatrix} +V \\ -Adj \end{bmatrix}_1 + X_2$
 where there exists no NP which
 dominates $\begin{bmatrix} +V \\ -Adj \end{bmatrix}_1$.

Notice that (3.26) will generate (3.20b) - * I told that we were in trouble a man who had a kind face. It might seem that this sentence could be excluded on the basis of the very general output condition on performance, which is stated in (3.27):

(3.27) Grammatical sentences containing an internal NP which exhaustively dominates S are unacceptable.⁸

(3.27) would explain why (3.20b) is unacceptable -- it contains an internal NP which exhaustively dominates the sentence that we were in trouble. Some condition like (3.27) seems to be necessary in any case: note that (3.27) also explains why the a-sentences of (3.28) to (3.33) are worse than the corresponding b- or c-sentences.

- (3.28) a. * Did that John showed up please you?
 b. Did the fact that John showed up please you?
 c. Did it please you that John showed up?
- (3.29) a.?* That that John showed up pleased her was obvious.
 b. ? That the fact that John showed up pleased her was obvious.
 c. That it pleased her that John showed up was obvious.
- (3.30) a. ?*For whether she died to remain unclear would spoil the play.
 b. ? For the question $\left. \begin{array}{l} \text{as to} \\ \text{of} \end{array} \right\}$ whether she died to remain unclear would spoil the play.
 c. For it to remain unclear (as to) whether she died would spoil the play.

- (3.31) a. ?* I want that Bill left to remain a
secret.
- b. I want the fact that Bill left to
remain a secret.
- c. I want it to remain a secret that Bill
left.
- (3.32) a. * What what I ate cost almost broke me.
- b. What the thing which I ate cost almost
broke me.
- c. What the thing cost which I ate almost
broke me.
- (3.33) a. * I went out with a girl who that John
showed up pleased.
- b. ? I went out with a girl who the fact
that John showed up pleased.
- c. I went out with a girl who it pleased
that John showed up.

In each of the a-sentences, (3.27) applies and explains their unacceptability. In the b-sentences, (3.27) does not apply, because a head noun (fact, question or thing) has been added to the internal sentence that produced the unacceptability in the a-sentences, so that they are no longer exhaustively dominated by NP. And in the c-sentences, extraposition has applied, and the offending sentences are no longer exhaustively dominated by NP.

•

But although (3.27) will explain why the a-sentences as a class are worse than the b- or c-sentences, it will not explain why (3.29a), (3.30a), and (3.31a) are slightly better than the others, which means it is not sufficient. And although (3.27) seems to be right, in many cases,⁹ I do not think it can explain the ungrammaticality of (3.20b), which I find to be absolute word salad. Sentences (3.28) to (3.33), while ponderous and taxing to read, are still decipherable, but (3.20b) is baffling. This means that some other condition must be placed on (3.26); what I believe to be the correct one is given in (3.34). (But cf. § 6.3.3 below)

(3.34) Condition 3: (3.26) BLOCKS if $Y = NP_j$, where

$$NP_j \neq [P + \underset{NP}{NP}]$$

(3.34) seems to produce the right results in many cases: it allows (3.15c) and (3.16c), but excludes (3.20b). Furthermore, it correctly prevents (3.35a) from becoming (3.35b), and (3.36a) from becoming (3.36b).

(3.35) a. I loaned a man who was watching the
race my binoculars.

b. * I loaned my binoculars a man who was
watching the race.

(3.36) a. She asked a man who was near the window
whether it looked like rain.

b. * She asked whether it looked like rain a
man who was near the window.

However, Condition 3 also incorrectly excludes (3.17c) -- We elected president my father, who had just turned 60, for president is an NP. At present I see no way around this wrong result.

Nevertheless, it seems beyond dispute that a rule like (3.26) must appear in the grammar so that complex NP can be displaced from their underlying positions. This rule will be optional, and it must be supplemented by some output condition which will stipulate that if a sentence contains an un-permuted complex NP "near the end" of its VP, the acceptability of the sentence is lowered. Thus, for instance, the sentences of (3.37) must all be designated to be unacceptable in varying degrees.

- (3.37) a. * We called my father, who had just turned 60, up.
- b. ?* We elected my father, who had just turned 60, president.
- c. ? All those speeches made my father, who had just turned 60, mad.
- d. * They gave my father, who had just turned 60, it.

However, there are many more sentence types than those in (3.37) which must be taken into account before this output condition can be stated in its fullest generality. Some of these follow:

- (3.38) a. He figured it out.
 b. * He figured out it.
 c. He figured that out.
 d. * He figured out that.
 e. He figured Ann out.
 f. ?* He figured out Ann.
 g. He figured something out.
 h. ? He figured out something.
 i. He figured the answer out.
 j. He figured out the answer.
- (3.39) a. * I sent him it.
 b. I sent him that.
 c. ? I sent him Andy.
 d. I sent him something.
- (3.40) a. ?* We elected the man who he had brought
 with him president.
 b. ? We made the reports which he had brought
 with him available.
 c. They gave the reports which he had
 brought with him to me.

Once again, I must emphasize that these judgments, which are not sharply defined in any case, may only hold for my own speech. Nevertheless, I would expect similar phenomena to exist in most dialects.

3.1.1.3.2. It seems to me that such facts of acceptability as those indicated in (3.37) - (3.40) can most readily be accounted for by a theory constructed along the following lines. First of all, all the sentences in (3.37) - (3.40) should be generated by the grammar and designated as being fully grammatical. With the exception of Complex NP Shift, (3.26), no conditions having to do with complexity will be imposed on any rule, and the same thing applies to conditions having to do with pronouns. This means that neither of the conditions on Particle Movement, (3.9), will appear, and both (3.37a) and (3.38b) will be generated. Similarly, the Dative Rule will not be restricted so as not to apply if the direct object is a pronoun: (3.37d) and (3.39a) will also be generated.¹⁰

Instead of restricting the operation of particular rules, I propose that an output condition, much like (3.27), be stated, which imposes an ordering upon the constituents which follow the verb of the sentence which contains them, and lowers the acceptability of sentences whose constituents are not arranged in accordance with this condition. It will be remembered that (3.27) had a similar effect: it rendered unacceptable perfectly grammatical sentences which contained an NP which exhaustively dominated the node S.

The output condition which I propose in (3.41) is highly tentative, for I have not done much research on this extremely

difficult problem. (The lower the number before a constituent in (3.41), the closer it must be to the verb.)

(3.41) Output Condition on Post-Verbal Constituents

1. Direct object pronouns
2. a. Indirect object pronouns
 - b. Demonstrative pronouns and integers used as pronouns (give me two)
3. Proper names
4. a. Particles (up in call up)
 - b. NP with no postnominal modifiers
5. Reduced directional phrases (out in let out)¹¹
6. NP like president in' elect him president
7. Single adjectives like available in make the reports available
8. Indirect object phrases and directional phrases
9. Non-complex NP with postnominal modifiers
10. Complex NP
11. company in keep company

The ordering in (3.41) is doubtless wrong in many particulars, but it incorporates some generalizations which cannot be expressed if conditions on rules, such as the ones stated on (3.9), are used instead of it. For instance, to say that direct object pronouns occupy the first place in such an ordering as (3.41) is to

•

simultaneously exclude both (3.38b) and (3.39a); but in a system which makes use of conditions on rules, one condition would be needed to exclude each. Furthermore, in this latter system, there is no way to indicate that both of the sentences to be excluded are unacceptable for the same reason, but (3.41) does make this claim, which I believe to be a true one.

I will now attempt to justify (3.41), insofar as that is possible in my present state of ignorance. In many cases, particularly in the higher numbers of (3.41), I have put one constituent before another on the basis of very scant evidence.

Firstly, (3.41) is only a partial ordering, and a number in it which is followed by the letters a and b indicates that for me, there seems to be no preferred ordering of the a-constituents with respect to the b-constituents. This is the case in two instances: I find no difference in acceptability between I called an old friend up and I called up an old friend (these are the two constituent types mentioned in 4 of (3.41)), nor between the sentences give me that! and give that to me! (2 of (3.41)).

Secondly, (3.41) makes the prediction that violations of the hierarchy which arises from permutations of constituent types which are close to one another in terms of (3.41) will lead to smaller losses of acceptability than permutations of constituent types which are far apart in (3.41), and this

prediction seems to be borne out in a number of cases. For instance, the sentence I tried to figure out John (3 follows 4) is better than I tried to figure out that (2 follows 4). I also find Let the dogs which are barking out (5 follows 10) somewhat better than Knock the dogs which are barking out (4 follows 10). These two sentences provide the motivation for distinguishing in (3.41) between the reduced directional adverbs discussed in footnote 11 and true particles. In addition, I find that while constituent types 4a and 4b are equally acceptable in either order, constituents of type 5 are more comfortable to the right of constituents of type 4b than to the left of them. So knock out the sentry! is as natural as knock the sentry out!, whereas let out the sentry! is somewhat less natural than let the sentry out!

My only motivation for ordering constituents of types 6, 7 and 8 as I have is that it seems to me that ^athat_Λ complex NP (type 10) can precede 8 more readily than it can precede 7, and 7 more readily than 6. This is exemplified in (3.40): (3.40a), which is the least acceptable for me, has the order 10-6; (3.40b), which is slightly better, has the order 10-7; and (3.40c), which is almost, if not totally acceptable, has the order 10-8.

Constituents of type 9, for example, the NP somebody strong, are ordered closer to the verb than complex NP like somebody who is strong. This explains why (3.13b), which has the order 9-4, is better than (3.13a), which has the order 10-4. The same explanation can be given for the difference in acceptability

between (3.14a) and (3.14b).

Finally, I have included in type 11 such words as company in keep company, through in see (someone) through, to in bring (someone) to and on in put (someone) on, because for me these words must always end their VP, unless a relative clause has been extraposed around them. In the sentences below, the a-sentences are the least acceptable, the b-sentences, in which a complex NP precedes a constituent of type 11, are somewhat more acceptable, and the c-sentences, in which Extrapolation from NP has applied, are the most acceptable of all, although they are still awkward.¹²

- (3.42) a. * He kept company some girls who had been injured in the wreck.
 b. ?* He kept some girls who had been injured in the wreck company.
 c. ? He kept some girls company who had been injured in the wreck.

- (3.43) a. * I insist on seeing through all the students who started out the term in my class.¹³
 b. ?* I insist in seeing all the students who started out the term in my class through.
 c. I insist on seeing all the students through who started out the term in my class.

- (3.44) a. * The doctor brought to the passengers
who had passed out from the fumes.
- b. * The doctor brought the passengers who
had passed out from the fumes to.
- c. ? The doctor brought the passengers to
who had passed out from the fumes.
- (3.45) a. * He tries to put on everyone who he
doesn't like.
- b. ?* He tries to put everyone who he doesn't
like on.
- c. ? He tries to put everyone on who he
doesn't like.

These sentences raise many problems I cannot deal with.

Firstly, I cannot explain why (3.43c) should seem more acceptable than the other c-sentences, or why (3.44b) should seem less acceptable than the other b-sentences. Secondly, it may be the case that the a-sentences are so bad that they should not be generated at all -- this would entail restricting (3.26) so that complex NP immediately to the left of such words as company, through, etc. could not undergo the Complex NP Shift Rule. More damaging is the fact that the hierarchy in (3.41) predicts that all the b-sentences should be the most acceptable of all, in fact perfectly acceptable, but in no case are they anything better than barely acceptable. This means that the hierarchy must either be

modified or that it must be supplemented by some supplementary output condition which lowers the acceptability of any sentence containing a complex NP near its end, even though the ordering in (3.41) is adhered to. So, for example, in (3.46), even though the object NP of the verb watch is complex and very lengthy, rule (3.26), Complex NP Shift, cannot move it over the VP talk because of Condition 2 on (3.26).

(3.46) * I watched the Indians who the man who had
been my advisor in my freshman year had
advised me to study when I got to Utah talk.

Notice also that the unacceptability of such sentences as (3.46) and of the b-sentences in (3.42) - (3.45) can be reduced by adding material to the end of the sentence:

(3.46') ? I watched the Indians who the man who had
been my advisor in my freshman year had
advised me to study when I got to Utah talk,
because I was fascinated by the way their
view of the world seemed to be constrained
by the structure of their language.

(3.42b') ? He kept some girls who had been injured in
the wreck company, and meanwhile I scouted
around to see if I could find a phone.

(3.43b') ? I insisted on seeing all the students who started out the term in my class through, after they had all chipped in to buy me a going-away present.

(3.44b') ?* The doctor brought the passengers who had passed out from the fumes to, but many of them suffered relapses at various times during the night.

(3.45b') ? He tries to put everyone who he doesn't like on, by pretending to be deaf.

These sentences show that it will be very hard to state in formal terms just what "near the end of an S" means, for it seems that the acceptability of sentences like the b-sentences and sentence (3.46) must be assigned by a quasi-continuous function of the length and complexity of the object NP and the length and complexity of what follows. And (3.41) is at best a first approximation of such a function.

3.1.1.3.3. One final important question which must be raised is the following: what is the theoretical status of such output conditions as (3.27) and (3.41)? In the case of the former, it seems that although it has not yet been formulated adequately, it is not being overly optimistic to hope that a more adequate version of (3.27) may turn out to be universal. But it is out of the

question that the particular content of a condition such as (3.41) could be universal, for in (3.41), the constituent types are defined with reference to constituents like Article, Reduced Directional Phrase, company in keep company, etc., all of which are peculiar to English. One might wish, therefore, to make a theoretical distinction between (3.27) and (3.41), referring to universal conditions as "performance filters," and to all language-particular phenomena, such as those discussed in connection with (3.41), as ordinary rules of particular grammars. In my opinion, it is correct to draw such a distinction, but I would like to emphasize that if (3.41) is to be added to the grammar of English, it will be a rule of a type which is completely different from other transformational rules. First of all, where other rules change one P-Marker to another, (3.41) does not: it merely changes the acceptability index of P-Markers. Secondly, "violations" of (3.41) do not produce total unacceptability (except in extreme cases), but rather a partial loss of acceptability, with the amount of loss a function of the input tree and the structure of the rule. It is easy to see that other rules are entirely different in this respect: if an ordinary rule applies to a tree it should not have applied to, or does not apply when it should have, it is either the case that an unintelligible string is produced (* 10 dollars was cost by the parking ticket), or if intelligible (though ungrammatical), the strings produced do not

vary in amount of deviance according to the input structure (that is, they forced me for me to wash myself is as deviant as I forced you for you to wash the vegetables.)

These considerations suggest that if (3.41) is to be put into the grammar of English, it should be segregated from the normal type of transformational rules, to whose output it applies, and placed in a component by itself, a component which I tentatively propose to call the stylistic component. Of course, (3.41) will not be the only rule in this component, but at my present state of knowledge, I can only suggest two other rules that seem to be likely candidates for inclusion in it. The first is the Scrambling Rule in Latin and other "free word order" languages, which will be discussed separately in § 3.1.2 below. The second is the condition which must be imposed on prenominal adjectives with respect to their closeness to the noun they modify. In the case of the latter problem, if adjective sequences were to be constrained in deep structure, an entirely new system of selectional restrictions would have to be created, and this system would only be used to generate the permissible sequences of adjectives, as far as I know. In other words, to attempt to account for order-of-adjectives phenomena in deep structure would require setting up an elaborate and totally ad hoc mechanism, which would greatly increase the class of languages characterized by the theory of generative grammar, but unnecessarily, for the extra descriptive power would be used to

solve only one problem. On the other hand, if another output condition, highly similar to (3.41), were to be added to the stylistic component, which the discussion above has demonstrated is likely to be necessary in any event, then the theory would not be weakened at all. Furthermore, it seems to me that the type of phenomena which the two conditions would account for are phenomena of the same type. That is, in both cases, we have to do with constituents which occur in a preferred order. It is not that let out John! and a spotted young dog are to be categorically ruled out, but rather that let John out! and a young spotted dog are more natural.¹⁴ So it seems to me that it would be wise to separate into disjoint parts of the grammar rules which must produce constituents in an order from which any deviations produce ungrammaticality,¹⁵ from rules which produce constituents in an order which, within limits, is variable. The only possible reason that I know of to question the decision to relegate constraints on the order of adjectives to the stylistic component is the possibility that NP with different orders of adjectives may not be synonymous, in which case, of course, order constraints would have to be stated in the base. It has been suggested by Quine (cf. Quine (1960) p. 138) that the NP a big European butterfly designates a butterfly that is both European and big, while the NP a European big butterfly may designate a butterfly which is in fact small, but is big for European standards. I am not sure of the validity of this example,

and I have not studied the problem closely enough to be able to say whether such examples are sufficient to refute my proposal to handle order-of-adjective phenomena in the stylistic component, or not. I mention the problem here only to call it to the attention of the reader.

3.1.1.4. To summarize briefly what I have touched on in this digression, I have suggested that to put two conditions on the previously proposed Particle Movement Rule, (3.9), was to miss the generalization that both conditions were merely extreme cases of a rule relating the length and complexity of constituents of verb phrases to their ordering after the verb. To capture this generalization, I have proposed adding a stylistic component to the set of components of a generative grammar, and stating in it language-particular output conditions, such as (3.41), which capture the notion of preferred order, and reduce the acceptability of sentences whose constituents are in an order other than the specified by the stylistic rules. It was in the ordering given in (3.41) that the notion of node deletion, the main topic of § 3, played a role, for the constituent types 9 and 10 were shown to function differently with respect to the other constituent types of (3.41), and these two types can be conveniently distinguished in constituent structure terms if the principle of S-pruning which was stated in (3.6) is made use of.

.

3.1.2. The second case which seems to require some notion of node deletion has to do with Latin word order. In Latin, as in languages like Russian, Czech, etc. the order of major elements within a clause is free, within certain limits. Thus the subject NP may precede or follow the VP, the object NP may precede or follow the V, etc. In Latin poetry, it was even possible for adjectives to be separated from the nouns they modified. Robin Lakoff has kindly provided me with the following example from Horace (Carmina (Odes I), 5)

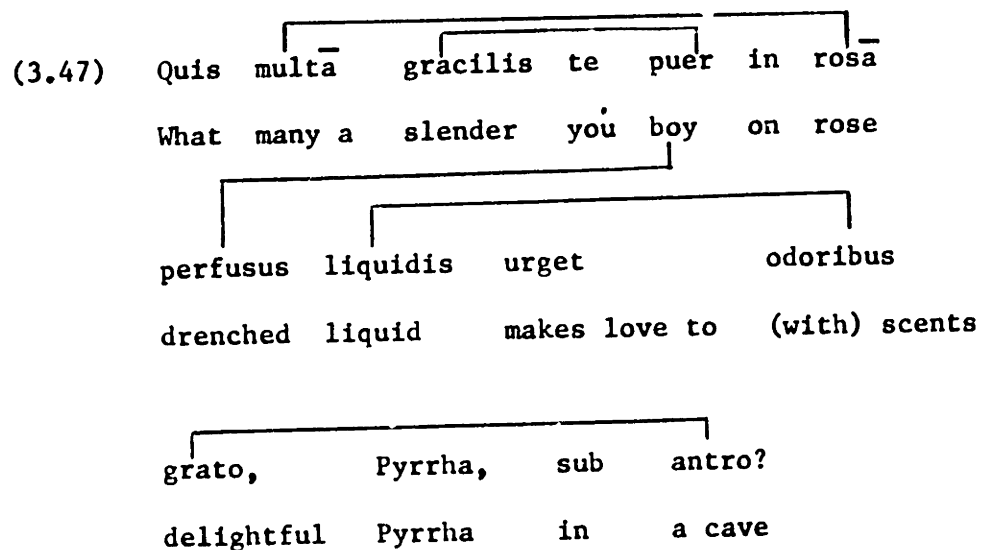

'What slender boy, drenched with perfumes
 Is making love to you, Pyrrha,
 On a heap of roses, in a delightful cave?'

Words in (3.47) joined by lines are discontinuous constituents which have been derived from contiguous constituents in a slightly deeper structure by a rule of roughly the following form:

(3.48) Scrambling

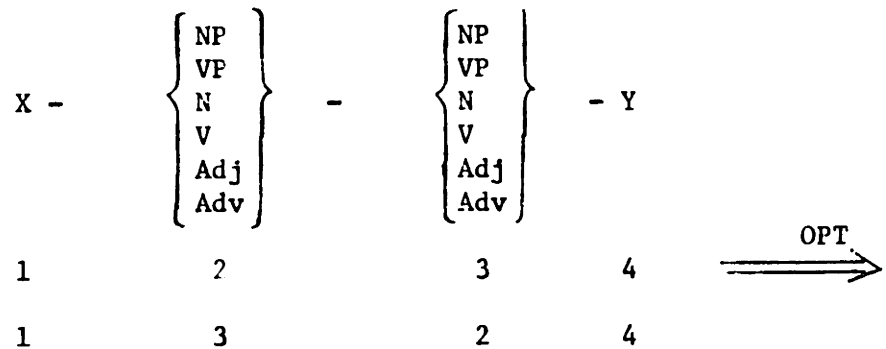

Condition:¹⁶ S_i dominates 2 if and only if
 S_i dominates 3.

Rule (3.48) scrambles major constituents, subject to the restriction that they be in the same clause. For instance, (3.48) will convert (3.49a) into (3.49b),

- (3.49) a. Homō bonus amat fēminam pulchram.
 b. Pulchram homō amat fēminam bonus.

'The good man loves the beautiful woman.'

because for the purposes of Scrambling, adnominal adjectives behave as if they were in the same clause as the nouns they modify. But note that this fact entails that node deletion has occurred, for in the underlying structure, adnominal modifiers are not in the same

clause as the noun they modify. The deep structure for (3.49) is that shown in (3.50). The latter is converted into the former by a rule of Relative Clause Reduction cognate with the one proposed in Smith (1961).

(3.50)¹⁷

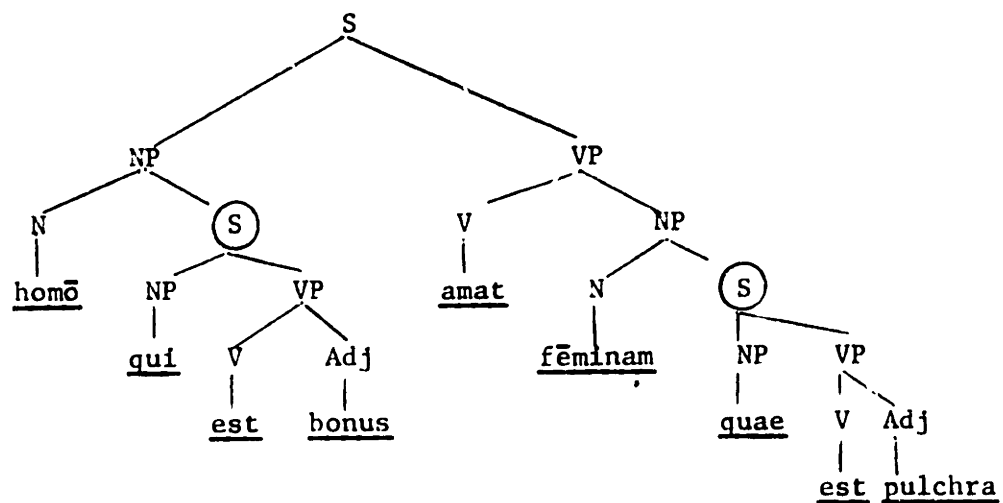

The Relative Clause Reduction Rule will delete qui est and quae est from the embedded relative clauses in (3.50). If the S-pruning principle of (3.6) were not in the theory of grammar, the circled S-nodes in (3.50) would not be deleted, and Scrambling would not be able to apply to the adjectives bonus and pulchram to permute them with the elements of the main clause of (3.50), for the adjectives would be in clauses of their own. But the fact that (3.49b) is grammatical indicates that Scrambling must affect them, and thus this fact constitutes further evidence for the correctness of principle (3.6).

For my present purposes, I am not overly concerned that (3.48) is too strong, for the problems involved in specifying exactly the correct subset of the strings which will be generated by (3.48) are far too complicated for me to even mention them here, let alone come to grips with them. In § 3.1.1.3 above, I suggested that rules like (3.48) be placed in the stylistic component, because they are formally so unlike other transformational rules. In the first place, since (3.48) can apply an indefinite number of times to its own output, every sentence will have an infinite number of derivations. It seems wrong to use normal rules of derived constituent structure to assign trees to the output of this rule, for the number of trees that will be assigned to any sentence, although it will be bounded, will be very large, and there will be no correlation between the number of derived trees and perceived ambiguities, as there is in happier circumstances. In short, it is clear that rules like (3.48) are so different from other syntactic rules that have been studied in generative grammar that any attempt to make them superficially resemble other transformations is misguided and misleading. They are formally so different from previously encountered rules that the theory of language must be changed somehow so that Scrambling can be placed in a different component from other syntactic rules, thereby formally reflecting the differences I have been discussing.

It is possible that Scrambling should be effected in the stylistic component, as I suggested in § 3.1.1.3.3, but it

should be emphasized that there are as many formal differences between Scrambling and output conditions like (3.41), which I also suggested should be stylistic rules, as there are between Scrambling and transformational rules like Extrapolation from NP. But it does seem, in some ill-defined sense, that Scrambling and output conditions like (3.41) both have to do with such low-level matters as taste or idiolect, which have often been grouped under the heading of stylistics; so that it may yet be appropriate to assert that they both belong in the same component of a grammar. But at present, our knowledge of constraints on Scrambling, or on conditions like (3.41), or in fact on any stylistic problems whatsoever, is so limited that nothing but speculation is appropriate.

One final point should be made with reference to Scrambling. It may be possible to formulate this rule in a partially universal way, so that it is only necessary to specify in a particular grammar whether it applies or not. This suggestion must be modified somewhat, for it appears that languages with "free word order" may differ among themselves as to the contents of the second and third terms of the Scrambling Rule. Thus although it appears that in Latin, adjectives can be permuted away from the noun they modify, this possibility either does not exist at all in Russian or is severely limited there. This suggests that the theory of language must be constructed in such a way that universal skeleton rules can be stated.

The skeleton for the universal scrambling rule would state that the subject NP can precede or follow the VP, that the VP can have its constituents arranged in any order, and possibly a few other universal conditions. In the grammar of any "free word order" language, it would then only be necessary to state that the scrambling skeleton rule could be applied, and to list any language-particular additions to the skeleton. For example, in both Latin and Russian, it would be necessary to note that scrambling could apply, and in Latin, it would be necessary to specify in addition that adjectives can be scrambled.

I should point out that such important traditional concepts as "free word-order language" can only be reconstructed by introducing some such notion as that of skeleton rule into linguistic theory, for, as I pointed out, the grammars of languages which exhibit "free" word-order do not all contain the same rule -- the rules in each which effect the scrambling are slightly different. Therefore, it is necessary to factor out that part of the various scrambling rules which is language-independent and to state this skeleton once in linguistic theory. Then the notion "free word-order language" can be equated with the notion "language having a grammar making use of the Scrambling skeleton."

All the points discussed in this section are highly conjectural, but they do not materially affect the point at hand,

which is that in order to state the version of the Scrambling Rule, no matter in what component it appears, nor how much of it can be factored out and put into a universal skeleton rule, some notion of tree-pruning must be in the theory.

3.1.3. A closely related phenomenon provides an additional piece of evidence for (3.6): the phenomenon of case-marking. In Latin, as in many other languages, noun phrases must be marked for case in various contexts. The exact number of cases which are distinguished in any particular language is not my concern here: the important thing is that when an NP is marked with some case, say accusative, then all markable elements of that NP must have the feature [+ Accusative] added to them. In Latin, determiners, adjectives, possessive adjectives, participles, some numerals, and the head noun of the NP are markable, and nothing else is. In particular, elements of clauses contained in an NP are not markable. Thus if the Relative Clause Reduction Rule does not apply to the rightmost circled S of (3.50) above, the adjective pulchra cannot be marked [+ Accusative]: sentence (3.51), which would be the result of such a marking, is ungrammatical.

(3.51) * homō qui est bonus amat fēminam quae est pulchram.

However, as sentence (3.49a) shows, once the Relative Clause Reduction Rule has applied, pulchra becomes markable, and the accusative form pulchram is produced. Once again, these facts can be

accounted for simply if some principle of node deletion is invoked. The case-marking rule, which distributes the case feature with which the whole NP is marked onto all markable elements dominated by it, must be constrained so that no elements are marked which are dominated by an S which is in turn dominated by the NP in question, as the ungrammaticality of (3.51) clearly shows. Therefore, in order for pulchra to become markable, after the quae est of the rightmost relative clause in (3.50) has been deleted, and the circled node S no longer branches, some S-pruning principle must delete it. Facts corresponding to these can also be found in Germanic, Slavic, and Balto-Finnic, so it is likely that the solution to the Latin case-marking problem is at least partially universal.

I might remark in passing, however, that there are many unsolved problems which have to do with the case-marking rule. Consider, for example, sentence (3.52) and its approximate labeled bracketing, (3.53):

(3.52) Puer amat puellam quae est similis deae.

'The boy loves a girl who is similar to a goddess.'

(3.53)

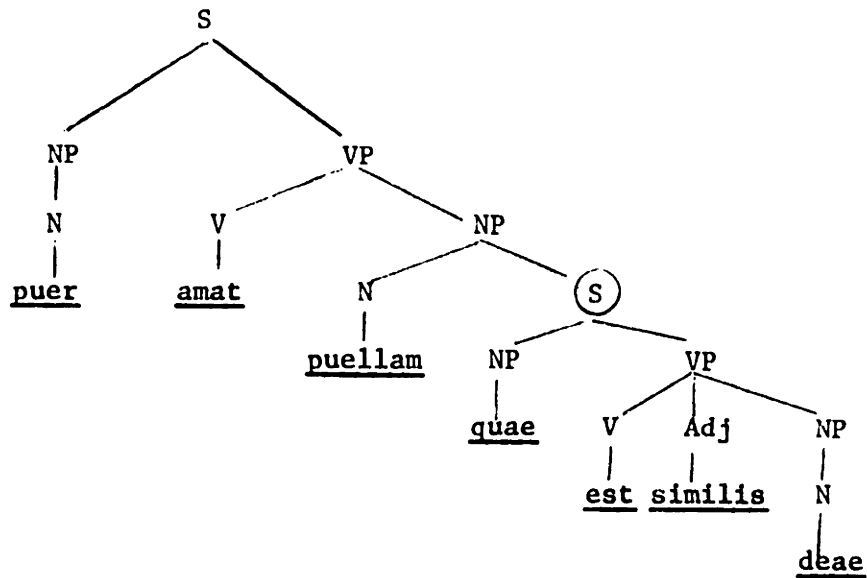

If the Relative Clause Reduction Rule applies to (3.53) to delete the quae est of the relative clause, principle (3.6) will delete the circled node S, as was the case with the P-marker (3.50), and the adjective similis, no longer contained in a clause dominated by the object NP of (3.53), will become similem, as in (3.54).

(3.54) Puer amat puellam similem deae.

The problem is to specify how the case marking rule is to be constrained so that deae 'goddess' (dative singular) will not become deam 'goddess' (accusative singular), for if this occurs, the sentence will no longer be grammatical (cf. (3.54')).

(3.54') * Puer amat puellam similem deam.

It might be proposed that the case-marking rule should not only be restricted from marking elements in clauses which are dominated by the NP being marked, but also from marking elements in NP which are dominated by the NP being marked. This, then,

would be a kind of A-over-A restriction which only applies to the case-marking rule. It can easily be seen how this condition will prevent deae in (3.53) from being incorrectly converted to deam, even if Relative Clause Reduction applies, and it can also be used to prevent (3.55a) from being converted into (3.55b)

(3.55) a. puella amat amīcī frātrem.

'The girl loves a friend's brother.'

b. * puella amat amīcum frātrem.

because at the time the case-marking rule would apply, the sentence (3.55a) would have approximately the structure shown in (3.56),

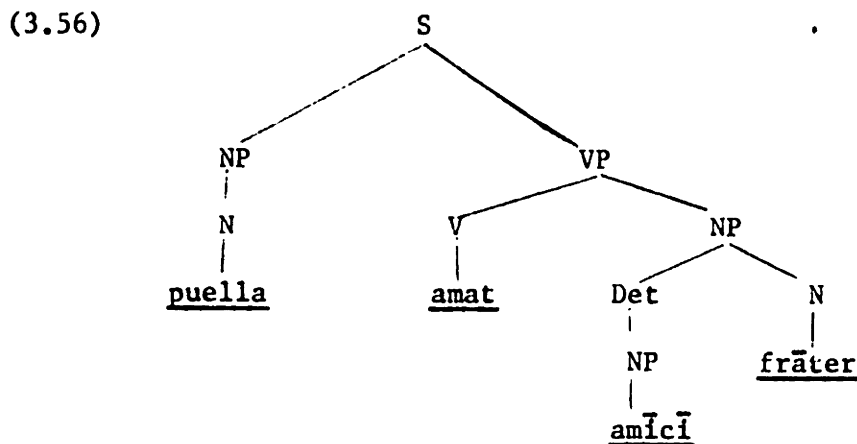

and since amīcī 'a friend (gen.)' is an NP dominated by an NP, the A-over-A restriction on the case-marking rule would prevent it from being changed to amīcum. Once again, the same facts obtain in Germanic, Slavic, and Balto-Finnic.

However, it seems that this limited A-over-A restriction is both too strong and too weak. It is too strong in that it would exclude (3.57) below

(3.57) puella amat meum frātre^m.

'The girl loves my brother.'

unless meum 'my' had somehow ceased to be dominated by NP, for otherwise the structure of (3.57) at the time case-marking applies would be exactly that shown in (3.56), except that meus would appear in the place of amici. In traditional grammar, words like meus are called "possessive adjectives," a term which aptly characterizes their behavior under case-marking rules, but which provides no explanation as to how they have come to behave differently from NP in the genitive case, like amici. I have no explanation for the facts at present, but Postal has suggested a promising new analysis of pronouns which may provide a key to the answer (Postal (1966)). Postal argues convincingly that personal pronouns such as I, you, he, etc., should be treated as underlying articles (actually, in the deepest structure, these articles, as well as words like the, a, some, etc., which have been traditionally categorized as articles, would all be represented as features on the noun they modify) which modify the pronoun one, and that they acquire their derived status as nouns because of a rule which deletes one and leaves its article (i.e., he, she, we, etc.) as the only

node still dominated by the node N which dominated one in the deep structure. I will not recapitulate here the various arguments Postal advances in support of this analysis: for my purposes, it is sufficient to assume their correctness. For if Postal's analysis is correct, and pronouns are articles at some stage in their derivational history, it may be possible to save the A-over-A condition on case-marking from being too strong. In § 3.2 below I will discuss briefly the possibility of there being a principle similar to (3.6) which would delete the node NP under certain conditions. At present there is only weak evidence for NP deletion, and I do not know how the principle effecting it should be formulated, if indeed such a principle should be added to the theory of grammar at all. But it seems to me that it may be possible to formulate it in such a way that if the structure underlying a pronoun is assigned the case feature [+ Genitive], somehow this structure is changed to meet the conditions for NP pruning, and the NP dominating it is deleted. The A-over-A restriction on the case-marking rule could then be kept. Thus, if the NP amīcī frāter 'a friend's brother' were marked [+ Accusative], frāter would change to frātrem, but amīcī would not change to amīcum, for amīcī would be dominated by NP, and the A-over-A condition on case-marking would be in effect. On the other hand, if meus frāter 'my brother' is marked [+ Accusative], the rule distributing the case which is assigned to the whole NP to the markable elements dominated

by the NP will affect both meus and frāter, for neither is a NP, and the correct form, meum frātrem will result. This proposal is highly programmatic at present, for it depends crucially on an exact formulation of the NP pruning principle, and such a formulation is not at present available.¹⁸

Although it does not seem possible at present to formulate a case-marking rule which is generally adequate, it seems to be true that in all languages which mark for case, elements in clauses dominated by the noun phrases being marked are not markable. I do not know whether in all case languages with a rule for reducing relative clauses, the unmarkable elements of the full clauses become markable after the clauses have been reduced, as is the case in Latin, Slavic, Germanic, and Balto-Finnic, but I suspect this to be true too.

Notice that if the former hypothesis is correct, another rule whose statement would require quantifiers (cf. fn. 7 above) can be relegated to linguistic theory. For if the hypothesis does not hold universally, then the case-marking rules for languages where it does hold would look roughly like this:

$$(3.58) \quad \left[\begin{array}{cccc} \text{NP}_i & X & - Y & - Z & - [+ \text{case}_j] \\ 1 & 2 & 3 & 4 & \end{array} \right]_{\text{NP}_i} \xrightarrow{\text{OBLIG}} \begin{array}{ccc} 1 & [2] & 3 \\ & [+ \text{case}_j] & 4 \end{array}$$

Condition: It is not the case that $\text{NP}_i > S_k$ and $S_k > 2$.

Here I have assumed that an earlier rule, which assigns a case to a whole NP on the basis of its syntactic function, has adjoined the node [+case_j] (this is a variable ranging over [+ Accusative], [+ Dative], etc.) to the entire NP, but nothing depends on this assumption. The important fact to notice is that subscripts, which are logically equivalent to quantifiers, must be used to state the condition. This is not to say that it is necessarily true that rules like (3.58) are not language-specific, but rather that if my hypothesis that elements of clauses are not markable proves to be wrong, it will be necessary to abandon at least in part the restriction that transformations must be stated without making use of quantifiers over P-markers (cf. § 6.4.1.1 below).

In summary, whether or not it turns out to be true that in all case-marking languages, full and reduced relative clauses behave differentially with respect to the case-marking transformation, the fact that it is true of Latin, Slavic, Germanic and Balto-Finnic supports the hypothesis that a principle for S-pruning must be in the theory of grammar, for the case-marking facts in these languages can be most economically explained on the basis of the differences in constituent structure which such a principle would produce.

3.1.4. The fourth example in which node deletion plays a role, which has to do with the placement of clitics in Serbo-Croatian, was discovered by Wayles Browne (cf. Browne (1966)). As Browne points out, there exists a rule in Serbo-Croatian which moves to the second position in their sentence all of the clitics (these are a number of short words like pronouns, the copula, a morpheme indicating the conditional, etc. -- an exhaustive listing of these words is not necessary here.) The clitics occur in a certain order there, but what this order is is not relevant here. For example, since the words je 'it' (acc.) and mi 'I' (dat.) are clitics, if no prior rules were applied to sentence (3.59), which has approximately the structure shown in (3.60), a rule of Clitic Placement would convert (3.60) to the structure underlying (3.61).

- (3.59) Ivan želi da Ivan čita je mi.
 Ivan wanted that Ivan read it to me.
 'Ivan wanted Ivan to read it to me.'

(3.60)

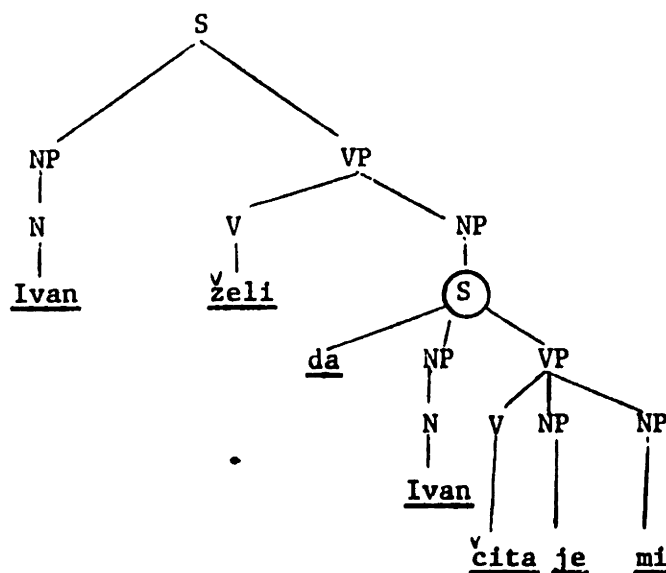

(3.61) Ivan ^vzeli da mi je Ivan ^včita.

'Ivan wanted Ivan to read it to me.'

However, when the subject NP of the embedded sentence is identical¹⁹ to some NP of the matrix sentence (just which NP is not relevant for this example), a rule which I will refer to as Equi NP Deletion optionally deletes the subject of the embedded sentence, simultaneously deleting the complementizer da 'that' and converting the main verb (čita) into an infinitive (čitati). But if this occurs, as Browne points out, the clitics je and mi must be moved to the position immediately preceding zeli 'wanted', for if Equi NP Deletion has applied, the sentence which must be produced is (3.62).

(3.62) Ivan mi je ^vzeli čitati.

It will be observed that the position of the clitics je and mi before the main verb of (3.62), zeli, provides compelling motivation for S-pruning, for if the circled occurrence of the node S in (3.60) is not deleted by (3.6) after the operation of Equi NP Deletion has caused it to cease to branch, Clitic Placement will apply vacuously to (3.60), for je and mi will already occupy second position in the most deeply embedded S. Thus unless node deletion applies, they will not move at all, and (3.62) will not be generated.

The clitics must be moved so that they become the second element of the first sentence above them. (Actually, they

are adjoined to the right side of the first element of this sentence, and are phonologically in the same word as this element. Thus, in (3.62) Ivan mi je is a phonological word.) It is of theoretical interest that, given the presently available theoretical conventions, it is only possible to specify formally that the clitics may not be moved out of the first sentence above them by using subscripts on rule conditions (or, equivalently, quantifiers on P-markers), as in (3.63) below.

(3.63) Clitic Placement²⁰

$$X - \left[\begin{array}{c} Y - Z - [+ \text{Clitic}] - W \\ S_i \qquad \qquad \qquad S_i \end{array} \right] - U$$

1	2	3	4'	5	6	OPT \Rightarrow
1	2+4	3	0	5	6	

Conditions: (1) 2 is a single node

(2) If $S_j > 4$, it is not the case that $S_i > S_j$.

It would of course be absurd to hope that such a rule as (3.63) could be universal, so the question is, must the restriction that conditions on transformational rules be Boolean conditions on analyzeability be given up? And if so, must all possible combinations of subscripts in conditions be countenanced? I believe the correct answers to these questions to be a qualified yes and a definite no, respectively. I will argue below, in

discussing the notion of bounding, that a new convention must be introduced into the theory of grammar: it must be made possible to refer to the right and left boundaries of the first sentence up or of the first sentence down from any term of the structural index of a transformation. If this convention is made available, I think that the unlimited power of quantificational conditions on rules need not be countenanced. However, I cannot argue these claims at this point in the exposition. I will return to them in § 5.

It should be obvious, however, that whether or not my proposed convention is or is not strong enough to obviate the need for quantificational conditions, and whether the rule for Clitic Placement should be stated as in (3.63), or in a new formulation which makes use of my proposed convention, the argument for S-pruning, which is my main concern here, remains valid. Unless principle (3.6) applies to delete the circled S in (3.60), after Equi NP Deletion has deleted da and Ivan, it will be necessary to add an ad hoc rule to derive sentence (3.62). This fact constitutes confirming evidence of the strongest kind that principle (3.6) must be in the theory of grammar.

3.1.5. The fifth example involving S-pruning has to do with sentences containing as or like.

- (3.64) a. Tom drives as that man drives.
 b. Tom drives as that man does.

c. Tom drives like that man.

I wish to argue that (3.64b) is derived from (3.64a) by the deletion under identity of the verb in the as-clause, and furthermore, that (3.64c) is derived from (3.64b) by the deletion under identity of the auxiliary in the as-clause. If only an NP follows as, it is obligatorily converted to like. There are, of course, dialects in which (3.64a) and (3.64b) are impossible unless like has been substituted for as there too. For me, in casual speech, (3.64a) and (3.64b) are only possible with like, although I believe the as-versions are the ones sanctioned for more formal purposes.

Note there is a difference in relativizability between the first two sentences and the last one. That is, relative clauses on the noun man cannot be formed from (3.64a) or (3.64b), although this is possible in the case of (3.64c).

- (3.65) a. * I know a man who Tom drives as drives.
 b. * I know a man who Tom drives as does.
 c. I know a man who Tom drives like.

I think the ungrammaticality of the first two sentences of (3.65) can be explained on very general grounds if the structure shown in (3.66) is postulated to be the approximate underlying structure for sentence (3.64a) (and thus, derivatively, for the other two sentences of (3.64) too).

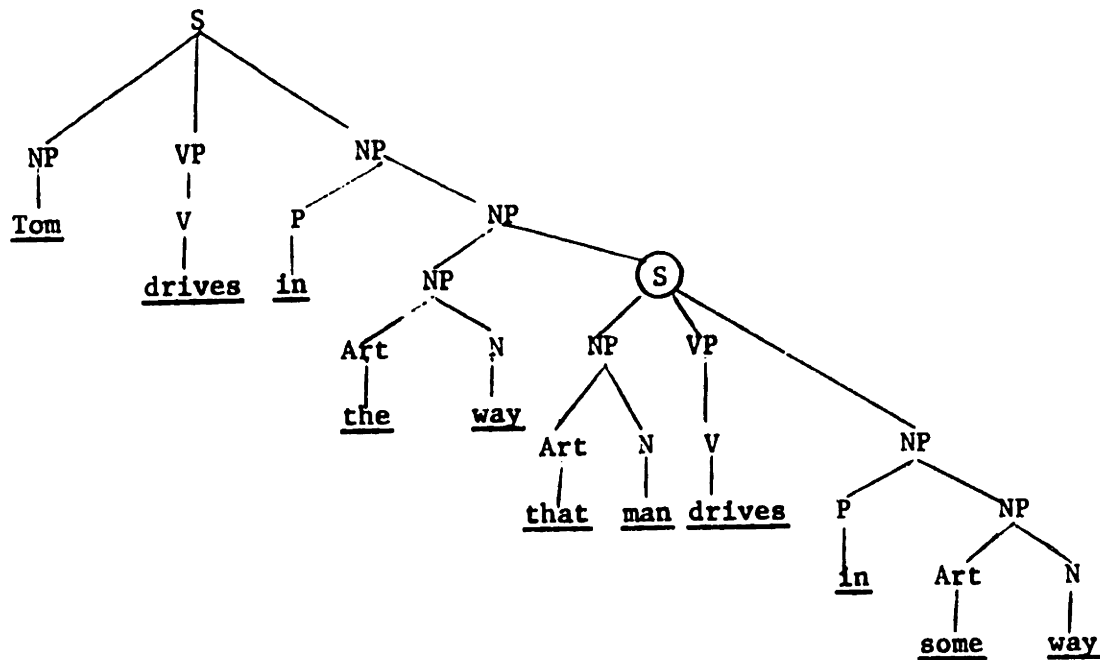
(3.66)²¹

After the relative clause rule and a rule deleting the preposition in have applied to (3.66), sentence (3.67) results:

(3.67) Tom drives the way that that man drives.

A later rule will have to convert the way that to as or like, depending on what follows, and if this rule can be ordered late, the fact that that man in (3.64a) and (3.64b) is not relativizable can be reduced to the fact that that man is not relativizable in (3.67). And this latter fact follows from a very general condition, which was stated in approximate form in (2.26) of § 2.4.1, and which will be gone into in greater detail in § 4.1, the Complex NP Constraint. It prevents the relativization of any element contained in a relative clause. This condition is met even

if the verb drive in the relative clause of (3.67) is deleted, under identity with the verb in the main clause, yielding (3.68), a structure which may later be converted into (3.64b).

(3.68) Toms drives the way that that man does.

But if the deletion proceeds further, and even the word does of (3.68) is erased, then the circled node S in (3.66) will cease to branch and will be deleted by principle (3.6). With this deletion, the condition ceases to be met, and the NP that man becomes relativizable.

Although the details of this explanation of the differences among the sentences of (3.65) will not become clear until the condition I have made use of is given final formulation in § 4.1, I think that enough has been said here to prove the point at hand -- that the explanation depends in a crucial way upon the notion of node deletion. Assuming that I am correct in supposing all the sentences in (3.64) should be derived from the same underlying structure, the fact that (3.64c) behaves differently than (3.64a) and (3.64b) with respect to the relative clause transformation suggests that the former sentence differs from the latter two in constituent structure. Principle (3.6), if adopted, would provide such a difference, so (3.6) is supported by the facts of (3.65).

3.1.6. The final three sets of facts which support (3.6) come from areas of grammar which I understand so poorly that I will not

even speculate as to what the full analyses in each case are, but merely suggest that when full analyses are available, they will make use of an S-pruning principle like (3.6).

The first of these sets of facts has to do with comparatives, and bears a strong resemblance to the case discussed immediately above, in § 3.1.5. Although both of the sentences in (3.69) are grammatical, as the sentences in (3.70) show, the NP that man is only relativizable in (3.69b), which has been derived from (3.69a) by deleting is.

- (3.69) a. John is taller than that man is.
 b. John is taller than that man.
- (3.70) a. * I know a man who John' is taller than is.
 b. I know a man who John is taller than.

Facts parallel to these in all respects can also be shown to hold for the comparison of equality.

- (3.71) a. John is as tall as that man is.
 b. John is as tall as that man.
- (3.72) a. * I know a man who John is as tall as is.
 b. I know a man who John is as tall as.

Although more efforts have been expended on the comparative than on any other construction, and although there exist a wide variety of proposed analyses to choose from (cf., e.g. Smith (1961), Lees (1961), Hale (1965), Hale (to appear), Lakoff (1965), Ross (1965) and Qualls (to appear)), it seems to me that no satisfactory deep structure

has been arrived at, although the range and complexity of examples that have been taken into consideration is extremely wide. I cannot, therefore, explain in detail why it is that (3.70a) and (3.72a) are ungrammatical, while (3.70b) and (3.72b) are not, but it does seem likely that the eventual explanation of this fact will hinge on the fact that the node S which dominates the phrase that man is in (3.69a) and (3.71a) will have been deleted by (3.6) when the word is is deleted by the transformation which converts (3.69a) and (3.71a) to (3.69b) and (3.71b) respectively.

3.1.7. The second set of facts which seems to depend on S-pruning also has to do with comparatives and with the way they interact with the rule which permutes an adjective from a reduced relative clause to prenominal position (this rule was discussed and given a preliminary formulation in § 2.3 above). Assuming that the adjectives in (3.73) - (3.75) are all derived from the same underlying structure, which is a moot point,

(3.73) a. Mary has never kissed a man who is taller than John is.

b. Mary has never kissed a man who is taller than John.

(3.74) a. Mary has never kissed a man taller than John is.

b. Mary has never kissed a man taller than John.

(3.75) a. * Mary has never kissed a man taller than John is.

- b. Mary has never kissed a man taller than John.

the ungrammaticality of (3.75a) is presumably to be explained by constraining the rule which accomplishes the shift of the adjective to prenominal position so that compared adjectives may only undergo this rule if the than-clause does not contain a sentence. Principle (3.6) asserts that this is not the case for (3.74b), although it is the case for (3.74a), and thus provides a basis for explaining the difference in grammaticality of (3.75a) and (3.75b).

I believe the facts of the comparison of equality to parallel these facts (cf. the sentences in (3.76)),

- (3.76) a. ?* Mary has never kissed as tall a man
as John is.
- b. Mary has never kissed as tall a man
as John.

but for some obscure reason, (3.76a) does not seem to me to be as clearly ungrammatical as (3.75a).

These constructions raise many interesting problems which cannot be gone into here, and so little is known about them that it may turn out that the explanation which I have proposed for the differences between (3.75a) and (3.75b) and between (3.76a) and (3.76b) is incorrect; but at the present state of knowledge, these differences seem to be connected with S-pruning in some way, and thus to provide weak support for principle (3.6).

3.1.8. The last case which seems to require S-pruning has to do with contrastive stress in Hungarian. Kiefer has noted (cf. Kiefer (1966)) that there exist adverbs in Hungarian which cannot be contrastively stressed. At present, this fact is totally isolated, unexplained, and, as a matter of fact, not statable within the present theory of grammar. Not enough is now known about these adverbs for it to be possible to predict how the theory will have to be changed to accommodate this fact, but there is one indication that S-pruning will figure into the solution.

Kiefer notes that the adverb állandoán 'constantly' is one of those which cannot bear contrastive stress in normal circumstances. That is, in the Hungarian equivalent of a sentence such as (3.77), állandoán could not be contrastively stressed.

(3.77) Valoiki állandoán érveket hozott fel.
 Somebody constantly arguments brought up.
 'Somebody constantly brought up arguments.'

But it is also a fact that if an NP in Hungarian is contrastively stressed, the first lexical element of that NP is the phonological carrier of the contrastive stress for the entire NP. And if the structure underlying (3.77) is embedded as a relative clause on the noun ervet 'argument', reduced, and shifted to prenominal position, as in (3.78), állandoán can become the first lexical element of an NP and, if that NP is contrastively stressed, állandoán will bear that stress.

(3.78) Az állandóan felhozott érvek rosszak voltak.

The constantly up brought arguments wrong were.

'The constantly brought up arguments were wrong.'

It seems reasonable to me that whatever the precise constituent structure reconstruction of the phrase "in normal circumstances", which I underlined above, may turn out to be, it will depend to some extent on whether the adverb to be stressed is immediately dominated by the node S or not, or possibly it will depend on the number of nodes intervening between the adverb in question and the "first sentence up." If either of these conjectures proves correct, then it will probably prove useful to invoke some principle of S-pruning like (3.6), so that the reduced relative clause állandóan felhozott 'repeatedly brought up' will no longer be dominated by the node S in (3.78). But here again, as in the case of the examples discussed in §§ 3.1.6. and 3.1.7, there are so many unsolved problems that it is impossible to be certain that S-pruning is involved.

3.1.9. To summarize briefly, in §§ 3.1.1. - 3.1.8, I have discussed eight cases which all support, some more strongly than others, the hypothesis advanced in § 3.0 -- that principle (3.6) should be added to the theory of grammar. There is an additional class of cases having to do with conjunction, which space limitations forbid me to go into here, but which will be discussed at length in Lakoff and Ross (in preparation b). The analysis of Conjunction

Reduction²² which we propose there depends crucially on pruning rules, in particular on a rule for pruning non-branching S, which thus constitutes further evidence for (3.6). Therefore, I feel that it is safe to conclude that pruning rules must appear in the theory of grammar, at least for the node S. The fragmentary evidence which suggests that rules which prune NP and VP may be necessary is discussed immediately below in § 3.2.

3.2. At present I know of no reasons other than intuitive ones for arguing that the node NP must be deleted; and the only argument except for intuition for deleting VP which I know of is connected, in a minor way, with the analysis of the Conjunction Reduction Rule which will be presented in Lakoff and Ross (op. cit.), but which cannot be gone into here. Yuki Kuroda first suggested the possibility that other constituents than S might be deleted.²³ His idea was that if the head of a phrase (the head of NP is N, of VP, V) is deleted, the phrase should be deleted with it. This idea seems to be a promising approach to the problem of establishing some constituent structure difference between meus and amīcī (cf. § 3.1.3 above), so that the case of the first can be changed, but not that of the second, but there are problems with it, aside from those mentioned in fn. 18. Thus, presumably phrases like the brave, the dead, the just keep their status as an NP, even though the underlying head noun,

ones, has been deleted. I have no argument for this other than intuition, but it does seem strongly counter-intuitive to claim, as Kuroda's principle would seem to force us to, that the phrase the brave in (3.79) is not dominated by NP.

(3.79) The brave are not afraid to die.

The intuition that the brave is a constituent of some kind in (3.79) is strong, and if it is not an NP, what is it? In research on conjunction conducted by Lakoff and me, it has seemed to us that a necessary, though not a sufficient, condition for node deletion is that the node not branch. So if Kuroda's principle is supplemented by the general condition that only non-branching nodes delete, the difficulty connected with (3.79) can be avoided. .

But there still remain problems which Kuroda's principle is not strong enough to handle adequately. Thus, in footnote 2 above, it was pointed out that it may seem counter-intuitive to call the word yellow in the NP his yellow cat a VP. But if my proposed analysis of predicate adjectives is correct (cf. (3.25) above), then yellow will be the head of a VP in the deep structure, so by what rule can this VP be pruned?

In short, while there is strong evidence that a principle of S-pruning is needed in the theory of grammar, and even evidence that supports the formulation of this principle which was given in (3.6), the evidence that NP and VP must be deleted is weak, and no adequate formulation has been found of principles by which their deletion might be effected.

Chapter 3

FOOTNOTES

1. I would like to acknowledge here my indebtedness to several of my friends and colleagues, whose ideas and counter-examples have greatly influenced the formulation of the principles in this chapter. Paul Postal, in a lecture for a course he conducted in the spring of 1965, first brought to my attention the counter-intuitiveness of much of the derived constituent structure (d.c.s.) which was assigned by the then current theory. This counter-intuitiveness, which is discussed in § 3.0, provided the original impetus for constructing a systematic theory of node deletion. To Yuki Kuroda I owe the important idea that node deletion might not be restricted to the node S, as I had originally proposed, but should rather be generalized to affect all branching nodes. His proposal will be discussed briefly in § 3.2 below, in connection with the problem of deletion of the node NP. I have profited from my discussions with Susumu Kuno about the problems of case-marking, and especially from many long conversations with George Lakoff about the consequences for principles of node deletion of an analysis of conjunction which will be presented in Lakoff and Ross (in preparation b).

2. It may also seem counter-intuitive to label the word yellow a VP, although this intuition is not so clearcut, to me, at least.
3. For some discussion of this analysis of imperatives, cf. Katz and Postal (1964). An important critique of this analysis, containing a large class of constructions that have hitherto not been taken into account is given in (Bolinger (1967).
4. For a detailed discussion of many problems in verb-particle constructions and references to earlier work on particles, cf. Fraser (1965).
5. For some discussion of this rule, cf. Smith (1961).
6. Postal and Lakoff have pointed out that words which traditionally categorized as verbs and adjectives are better considered to be subcategories of the same lexical category, Predicate, which, following Lakoff (cf. Lakoff (1965)), I will designate with the feature [+V]. What were traditionally called adjectives are designated with the feature bundle $\begin{bmatrix} +V \\ +Adj \end{bmatrix}$, and what were traditionally called verbs are designated by $\begin{bmatrix} +V \\ -Adj \end{bmatrix}$.

7. It should be emphasized that the use of a subscript on $\begin{bmatrix} +V \\ -Adj \end{bmatrix}_i$ in Condition 2 conceals a hornet's nest of problems. In the first place, there is only one other rule which I know of which can only be stated by using subscripts: the rule which scrambles major constituents in a clause in so-called "free word-order languages" like Latin, Serbo-Croatian, Russian, etc. This rule will be discussed in § 3.1.2. Secondly, it is evident that the subscripts in the condition on (3.26) are used in a way which is logically equivalent to using quantifiers. That is, Condition 2 has the following logical structure:

$$\left(\text{for all } \begin{bmatrix} +V \\ -Adj \end{bmatrix}_i \right) \left[\left(Y = X_1 + \begin{bmatrix} +V \\ -Adj \end{bmatrix}_i + X_2 \right) \text{ if and only if} \right. \\ \left. \left(\text{there is an } NP_j \right) \left[NP_j \text{ dominates } \begin{bmatrix} +V \\ -Adj \end{bmatrix}_i \right] \right]$$

Aside from these two rules, it has previously been thought possible to restrict conditions on transformational rules to Boolean conditions on analyzability (cf. Chomsky (1965), p. 144). George Lakoff and I will argue in our forthcoming monograph (Lakoff and Ross (op. cit.)), that it must also be possible to state conditions in terms of immediate domination, a notion which can only be defined logically with quantifiers, if the only primitive notion in the theory is domination (cf. § 2, fn. 6 above). That is, to say that A immediately dominates B is to say that there exists no node Z such that A dominates Z and Z dominates B. However, I would be opposed to the

suggestion that the restriction to Boolean conditions on analyzability be dropped entirely, for to drop it would be to greatly increase the set of possible rules and thereby to weaken the theory. It may be possible to restrict quantifiers to conditions on very late transformational rules, which is much to be preferred to allowing such restrictions on any rule whatsoever. It seems likely that both (3.26) and the Scrambling Rule can come very late in the ordering, but too little is known about this at present.

8. I here make use of the distinction between grammaticality and acceptability discussed by Chomsky (1965)', § 1.2. By "internal", I mean "embedded", in the technical sense defined in Chomsky (1961) -- that is, an NP is internal to a sentence if it is both preceded and followed by non-null parts of that sentence. I have used the word "internal" here because it seems to me that in recent work, the word "embedded" has been used in a sense different from Chomsky's original one -- a sense which must be excluded for the purposes of (3.27). For example, it is often said that the sentence Bill was sick is "embedded" in the sentence Everyone thought that Bill was sick, even though it is not internal to it (in my sense).

9. Sentences like the following, which (3.27) would predict to be unacceptable, but which are in fact far more acceptable than (3.28a) - (3.33a),

Bill said (that) for her to enlist would be impossible.

Jack thinks (that) what he's eating is scrambled eggs.

constitute counterevidence to (3.27). At present, I do not see how to modify it so that these sentences will not be produced with as low an acceptability index as is assigned to (3.28a) - (3.33a).

10. The Dative Rule relates sentences like I gave Mary a book and I gave a book to Mary. It is thoroughly discussed in Fillmore (1965b).

Emmon Bach has recently pointed out (cf. his note "Problem-inalization" University of Texas mimeograph, 1967) that certain facts about the Dative Rule and Pronominalization in German lead to an ordering paradox. The same holds true of English, which I will discuss here.

It has been usual to make the Dative Rule obligatory if the direct object is a pronoun, thus excluding (3.37d) and (3.39a).

(Here I have assumed that sentences like I gave Mary a book are basic and that sentences with to are derived from them, but nothing depends on this assumption.) This presupposes the ordering below:

PronominalizationDative

But there are sentences which suggest that the reverse ordering is necessary:

I gave Molly_i her_i book.

* I gave her_i Molly's_i book.

I gave Molly's_i book to her_i.

* I gave her_i book to Molly_i.

It will be seen that the pronoun always follows the noun it refers to in these sentences. This means that the ordering or the rules must be,

DativePronominalization

for if the reverse order obtained, the first of the four sentences could be converted into the fourth. But if Dative is optional and precedes Pronominalization, how can the following derivation be prevented?

BASE: I gave the girl who wanted the book_i the book_i

(Dative optionally
does not apply)

(Pronominalization
applies)



* I gave the girl who wanted the book_i it_i.

The only solution I can find within the current theory is to postulate a second Dative Rule which applies only when the direct object has become a pronoun. Obviously, however, the current theory is wrong and must be modified. The modification I propose is taken up immediately below.

11. Fraser (op. cit.) made the interesting discovery that a subclass of what had previously been thought to be verb-particle combinations, verbs like let out, take in, load on, elbow off, etc., should really not be treated as verb-particles at all. Rather, verbs like these should be considered to be derived from verb phrases like let (it) out (of something), take (it) in (to something), load (it) on (to something), elbow (it) off (of something), etc., where the prepositional phrase in parentheses is deleted by the rule which converts John smokes something to John smokes, and I approve of something to I approve, a rule which seems to be required in a wide variety of cases, but which has never been studied intensively. Fraser points out several facts about these verbs which show clearly their differences from ordinary verb-particle combinations:

- 1) The prepositions of these verbs will conjoin (he took boxes in and out), particles will not (*I showed her up and off).

- 2) These verbs do occur in action nominalizations, while verb-particles do not (his bringing of the trays in, but not *his eking of a bare existence out).
- 3) Some directional phrases, like into the house or out of the window, may always occur with these verbs (he let her out into the garden, they were loading them on from the warehouse, he elbowed it off into the well, they took it in up the stairway), but there are verb-particle constructions which exclude them (*I burned it up from Boston) *I showed her up out of the window, *Sheila whiled the morning away into the well).
- 4) If a verb stem occurs with one of these prepositions from reduced directional phrases, it will occur with many more. Thus, since throw out is one of these verbs, it is to be expected that other directional prepositions will also occur with throw (e.g., over, under, down, up, off, across, on, in, away, around). The same is true of verbs like bring, take, send, shoot, hand, etc., but no such prediction is possible with true verb particles. Thus, although figure out exists, there is no figure off, figure in, etc.

After the unspecified NP and second preposition have been deleted from a VP like let the cat out (of something), the remaining preposition, out, is optionally moved to the left, around the object NP, and adjoined to the verb.

12. Sentences like (3.42), (3.44), and (3.45) point up a very interesting fact: there are well-formed deep structures which no sequence of rules can convert into fully acceptable surface structures. Trivial examples of this kind have been known for some time-- one such example is any well-formed deep structure which would result in a surface structure so long that it could not be scanned in one lifetime -- but to the best of my knowledge, it has not been noted previously that short sentences which have this property also exist. Such sentences provide evidence of the strongest kind for output conditions like (3.41), for without such conditions, a grammar would have to claim that one of the versions of (3.42), (3.44) and (3.45) is fully acceptable, a claim which is simply not true.
13. Sentence (3.43a) is acceptable, of course, if the main verb see through is taken to mean (approximately) "not be fooled by", but not if it means "continue to support until some specified end point."

14. The most detailed treatment of this problem which I know of is given in a paper by Zeno Vendler, "The order of Adjectives," Transformations and Discourse Analysis Project paper number 31, University of Pennsylvania mimeograph.

Mark Liberman has recently pointed out that the word one is ambiguous in the sentence James bought a wonderful old brick house and I bought a wooden one. One can mean simply house, but it can also mean wonderful old house. Since it is desirable to restrict pronominalization to constituents, this suggests that the input structure of the above sentence, when one has the latter meaning, must be the one underlying the unacceptable string *James bought a brick wonderful old house and I bought a wooden wonderful old house. The rule which inserts the pronoun one matches the double-underlined phrases and optionally replaces the right-hand phrase with one. If one is not inserted, some rule which scrambles pronominal adjectives optionally applies to the adjectives in both of the conjoined sentences, and some output condition will then evaluate the acceptability of the output string. Liberman's observation seems to me to provide extremely strong evidence for modifying the theory of grammar so that it contains some kind of stylistic component, for I can see no way of accounting for it within the present theory.

15. As a case in point, consider preverbal pronouns in French.
Il y'en a des autres is grammatical, whereas *il en y'a des autres is totally ungrammatical.
16. On the theoretical implications of using subscripts in conditions on rules, cf. fn. 7 above.
17. In diagram (3.50), I have, for expository purposes only, not given what I believe is the correct labeled bracketing. In Latin, as in English, there is reason to think that the underlying structure of sentences containing predicate adjectives is roughly that shown in (3.25).
18. Unfortunately, there are facts in Latin and Russian which will remain unaccounted for, even if some principle for NP pruning can be worked out. For in these two languages, third person pronouns in the genitive case do not become "possessive adjectives" (i.e., their case is not changed by the case-marking rule). Thus, while meus frāter 'my brother' becomes meum frātrem in the accusative case, eius frāter 'his brother' becomes eius frātrem, not the parallel *eum frātrem. But in German, third person genitive pronouns do inflect like adjectives, so it is clear that while many features of the case-marking rule may be universal, these interact with language-particular features in a way that is at present inexplicable.

19. It has been realized for a fairly long time that the notion of identity which is required in the theory of grammar must include identity of reference (hints of this are present in Chomsky (1962), p. 238, and a specific proposal for formally indicating coreferentiality is made in Chomsky (1965) p. 145-147). In addition, as Lees pointed out (cf. Lees (1960), p. 75), identity of strings of words is not sufficient; rather the requisite notion must be defined as identity of constituent structure. The example Lees uses to point out this interesting fact is the following. Since both sentences a and b below occur,

a. Drowning cats are hard to rescue.

b. Drowning cats is against the law.

if string identity were sufficient to correctly predict what non-restrictive relative clauses can be formed, it should be possible to embed sentence b into sentence a, for both share the string drowning cats. But the ungrammaticality of c shows that the stronger type of identity which was proposed by Lees must be adopted.

c. *Drowning cats, which is against the law, are hard to rescue.

In fact, there are examples which show that an even stronger notion of identity is necessary: a constituent which is to be pronominalized by virtue of its identity to some other constituent

must be identical in deep structure to that constituent. Examples which illustrate this point involve syntactically ambiguous sentences which are derived from different deep structures but have the same d.c.s. Several such sentences are given below.

- d. I know a taller man than John.
- e. When did Bill promise to call me?
- f. The shooting of the prisoners shocked me.

In d, one reading derives from a deep structure containing the deep structure of John knows a tall man, the other from one containing the deep structure of John is tall. In e, when can modify promise or call, and in f, prisoners can have been derived from an underlying subject (the prisoners shot something) or from an underlying object (someone shot the prisoners). If any of the sentences in d, e, or f is pronominalized as in g, h, or i,

- g. He told Peter that I know a taller man than John, but Peter didn't believe it.
- h. I divulged when Bill promised to call me, but I did so reluctantly.
- i. I'll talk to John on Friday about the report that the shooting of the prisoners shocked me, and to his wife on Saturday.

it is clear that reference has been made to the deep structures of d, e, and f, for the sentences in g, h, and i are only ambiguous

in two ways, not four.

The problems that deep structure identity raise for linguistic theory are extremely complex. They will be taken up in detail in Lakoff and Ross (op. cit.). Cf. also § 5.2.3.1 below.

20. At present, rule (3.63) is not stated correctly, for according to the specification of elementaries given in the structural change there, the clitics are adjoined to the first element of the first sentence above them as sisters. Thus they will not, without some special provision for the introduction of word boundaries, be part of the first word of the sentence. What seems to be necessary is that the clitics be adjoined to the first element of the sentence by a new type of adjunction: daughter adjunction. What must happen is that the leftmost branch of (3.60), which I have reproduced here and labeled a, must be converted into either b or c, depending on how the word boundary rules are formulated.

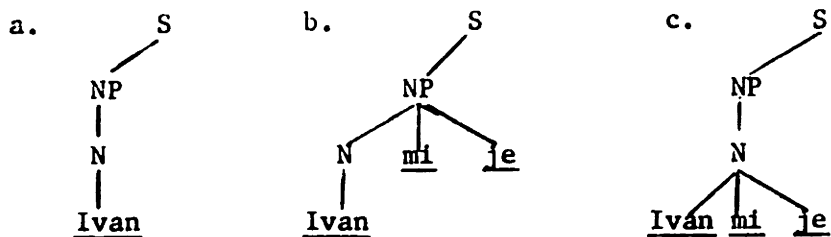

This rule is the only one I know of where daughter adjunction is required, and I am reluctant to argue, on the basis of this rule alone, for a change in the number of kinds of elementary

operations which the theory of grammar provides. At present I can see no other course to follow, but I will postpone proposing such a radical change in the theory until more is known about Clitic Placement or until other rules are found whose statement requires daughter adjunction.

21. The reasons for arguing that manner adverbs are not constituents of VP, as was proposed in Chomsky (1965), but rather of S, are presented in Lakoff and Ross (1966).
22. This is the rule which reduces such sentences as John knows the answer and Bill knows the answer to John and Bill know the answer, and Otto sells Buicks and Otto sells Fords to Otto sells Buicks and Fords, etc. (Cf. §§ 4.2.4.1, 5.3.2.4, 6.1.2.3.)
23. In an unpublished, untitled paper written in the fall of 1965.

Chapter 4

CONSTRAINTS ON REORDERING TRANSFORMATIONS

4.0. In this chapter and the next one, I will propose a set of constraints, some universal, some language-particular, which I will show to have roughly the same effect as the A-over-A principle. That is, I will show that with these constraints, it is possible to account for the six constructions in § 2.2 which constitute evidence for the principle, while avoiding the counter-examples of § 2.1. The A-over-A principle was postulated to be a constraint on transformational operations of all kinds, but I will attempt to show, in Chapter 6, that the constraints of Chapters 4 and 5 (and hence, the principle as well) should only apply to transformations which exhibit certain well-defined formal properties. The constraints of Chapter 4 only affect what I will refer to informally as reordering transformations -- transformations which have the effect of moving one or more terms of the structural description around some other terms of it. (The precise definition of this notion will not be given until Chapter 6.) Two examples of reordering transformations are the Question Rule and the Relative Clause Formation Rule, which are stated very schematically in (4.1) and (4.2) below.

(4.1) Question

Q - X - NP - Y

1 2 3 4

1 3+2 0 4

OBLIG

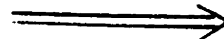
Condition: 3 dominates WH + some(4.2) Relative Clause Formation

W - [NP NP - [S X - NP - Y] S] NP - Z

1 2 3 4 5 6

1 2 4+3 0 5 6

OBLIG

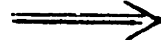

Condition: 2 = 4

I will use ungrammatical questions and relative clauses to illustrate the effects that the constraints of this chapter have on all reordering transformations. In Chapter 6, I will present a list of all the other reordering transformations I know of, and show that they obey the same constraints.

4.1. The Complex NP Constraint

4.1.1. It is to Edward S. Klima that the essential insight underlying my formulation of this constraint is due. Noticing that the NP that man could be questioned in (4.3b), but not in (4.3a) (cf. (4.4)), Klima proposed the constraint stated in (4.5):

- (4.3) a. I read a statement which was about that man.
 b. I read a statement about that man.
- (4.4) a. * The man who I read a statement which was
 about is sick.
 b. The man who I read a statement about is
 sick.
- (4.5) Elements dominated by a sentence which is
 dominated by a noun phrase cannot be
 questioned or relativized.

If Klima's constraint is used in conjunction with the principle for S-deletion stated in (3.6), it can explain the difference in grammaticality between (4.4a) and (4.4b), for it is only in (4.3a) that the NP that man is contained in a sentence which is itself contained in an NP: when (4.3a) is converted into (4.4b) by the Relative Clause Reduction Rule, the node S which dominates the clause which was about that man in (4.3a) is pruned by (3.6).

Although I do not believe it is possible to maintain (4.5), for reasons I will present immediately below, it will be seen that my final formulation of the Complex NP Constraint makes crucial use of the central idea in Klima's formulation: the idea that node deletion affects the potential of constituents to undergo reordering transformations. This hypothesis may seem obvious, at the present stage of development of the theory of grammar, but when Klima first suggested it, when the theory of tree-pruning was much less

well-developed than it is at present, it was far from being obvious.

In fact, this idea is really the cornerstone of my research on variables.

4.1.2. As I intimated above, however, I find that (4.5) must be rejected, in its present form. For consider the NP that man in (4.6): as (4.7) shows, it is relativizable,

(4.6) I read $\left[\begin{array}{l} \text{[S that the police were going to} \\ \text{interrogate that man]}_S \end{array} \right]_{NP}$.

(4.7) the man who I read that the police were going to interrogate

and yet the that-clause which contains it would seem to be a noun phrase, as I have indicated in the bracketing of (4.6). Presumably, the approximate deep structure of (4.6) is that shown in (4.8),

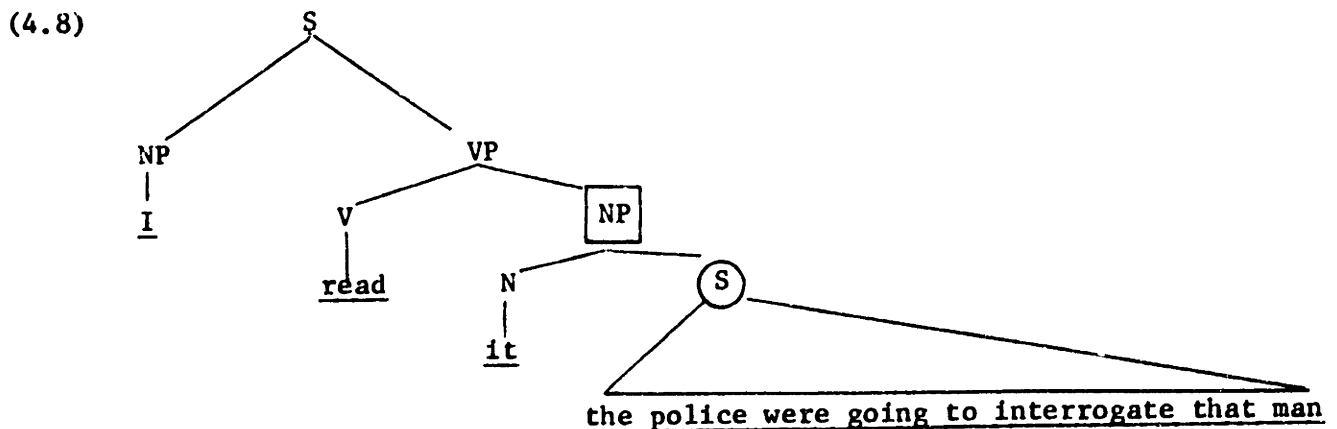

and unless some way is found of pruning the circled node S or the

boxed node NP in (4.8), condition (4.5) will prevent the relativization of that man. There is abundant evidence that the first alternative is not feasible:

- (4.9) a. I read that Bill had seen me.
 b. * I read that Bill had seen myself.
- (4.10) a. Evidence that he was drunk will be presented.
 b. Evidence will be presented that he was drunk.
- (4.11) a. That Bill_i was unpopular distressed him_i.¹
 b. That he_i was unpopular distressed Bill_i.

The Reflexivization Rule does not "go down into" sentences (cf. Lees and Klima (1963), Postal (1966b)); thus the fact that (4.9a) is grammatical, while (4.9b) is not, is evidence that that-clauses are dominated by S at the time that reflexivization takes place. Similarly, the fact that that-clauses may be extraposed, as is the case in (4.10b), indicates that they are dominated by the node S at the time that this rule applies. Finally, the fact that backward pronominalization² into that-clauses is possible (cf. (4.11a)) also argues that they must be dominated by the node S. So it seems implausible that the circled node S should be deleted by some principle which supplements (3.6), and there is no independent support for such an additional pruning principle in any case. Therefore, the only other way to save (4.5) is to claim that the boxed node NP must be deleted in the process of converting (4.8) into the surface structure which underlies (4.6).

Can the node NP be deleted? In § 3.2 above, I discussed briefly Kuroda's proposal to generalize the notion of tree-pruning in such a way that any non-branching node whose head had been deleted would be pruned. While it is possible to propose such a generalized version of (3.6), there is as yet no syntactic evidence which indicates that node deletion must prune out occurrences of NP or VP. The complex problems involving case-marking with respect to amīcī and eius on the one hand and meus on the other, which I discussed in § 3.1.3 above, might be solvable if use were made of some principle of NP deletion, but this has yet to be worked out in detail; and unless some other evidence can be found for NP pruning, invoking it to delete the boxed NP in (4.8) is merely ad hoc. For there are many pieces of evidence which show that that-clauses are dominated by NP at some point in their derivation.

- (4.12) a. That the defendant had been rude was stoutly denied by his lawyer.
- b. What I said was that she was lying.
- c. Bill told me something awful: that ice won't sink.
- d. Muriel said nothing else than that she had been insulted.

That-clauses passivize (4.12a), they occur after the copula in pseudo-cleft sentences (4.12b), after the colon in equative sentences (4.12c), and after than in sentences like (4.12d): in all of these

contexts, phrases can occur which are unquestionably noun phrases (e.g., Little Willy, potatoes, flying planes, etc.), and Lakoff and I argue that the syntactic environments defined by (4.12) can only be filled with noun phrases (cf. Lakoff and Ross (in preparation a)). If our arguments are correct, then that-clauses must be dominated by NP at some stage of their derivation. But it might be claimed that the late rule of It Deletion³, which deletes the abstract pronoun it when it immediately precedes a sentence, could change phrase-markers in such a way that the NP node which dominated it S would undergo pruning before Question and Relative Clause Formation had applied. Not enough is known about rule ordering at present for this possibility to be excluded, but it should be noted that even if it should prove to be possible to order It Deletion before all reordering transformations, thereby accounting for the grammaticality of (4.7) by providing for the deletion of the boxed NP of (4.8), it would still be necessary to explain why there is no difference in grammaticality between (4.13a) and (4.13b),

- (4.13) a. This is a hat which I'm going to see to it
that my wife buys.
- b. This is a hat which I'm going to see that
my wife buys.

After the verb see (to), the deletion of it is optional (in my dialect), and therefore, by the previous argument, while the

that-clause in (4.13b) might not be dominated by NP, the that-clause in (4.13a) still would be. So unless some additional convention for NP pruning could be devised for this case too, (4.5) would not allow the generation of (4.13a). Again, I must reiterate that there is no known evidence for pruning NP under any other circumstances, so the ad hoc character of the explanation which is necessitated if (4.5) is adopted is readily apparent.

But there is an even more compelling reason to reject (4.5) than the ones above: as I pointed out in § 2.4.1 above, it is in general the case that elements of reduced relative clauses and elements of full relative clauses behave exactly the same with respect to reordering transformations. This can be seen from the following examples: NP which are in the same position as Maxime in the sentences of (4.14) cannot be questioned (cf. the ungrammaticality of (4.15)),

- (4.14) a. Phineas knows a girl who is jealous of
Maxime.
b. Phineas knows a girl who is behind Maxime.
c. Phineas knows a girl who is working with
Maxime.

- (4.15) a. * Who does Phineas know a girl who is jealous of?
b. * Who does Phineas know a girl who is behind?
c. * Who does Phineas know a girl who is working
with?

nor can they be questioned, even after the relative clauses of (4.14) have been reduced (this is evidenced by the ungrammaticality of (4.16)).

- (4.16) a. * Who does Phineas know a girl jealous of?
 b. * Who does Phineas know a girl behind?
 c. * Who does Phineas know a girl working with?

It was facts like these which motivated the condition stated in (2.26) above, which I repeat for convenience here.

(2.26) No element of a constituent of an NP which modifies the head noun may be questioned or relativized.

In the light of the facts of (4.15), and (4.16), it would appear that it is the grammaticality of (4.4b) which is problematic, not the ungrammaticality of the sentences in (4.16). And there are parallel facts which have to do with Reflexivization, which I will present in § 4.1.6 below, which also support this interpretation. So condition (4.5), which takes the differences between the sentences in (4.4) to be typical, would seem to be a projection to an incorrect general conclusion from a case where special circumstances obtain. In the next section, I will give some evidence which allows the formulation of a broader-based generalization.

4.1.3. The sentences of (4.17), which only differ in that the NP object of believe has a lexical head noun in the first, but not in the second, differ as to relativizability, as the corresponding sentences of (4.18) show.

(4.17) a. I believed the claim that Otto was wearing this hat.

b. I believed that Otto was wearing this hat.

(4.18) a. * The hat which I believed the claim that Otto was wearing is red.

b. The hat which I believed that Otto was wearing is red.

If the analysis proposed by Lakoff and me (op. cit.) is correct, the d.c.s. of (4.17a) will be roughly that shown in (4.19):

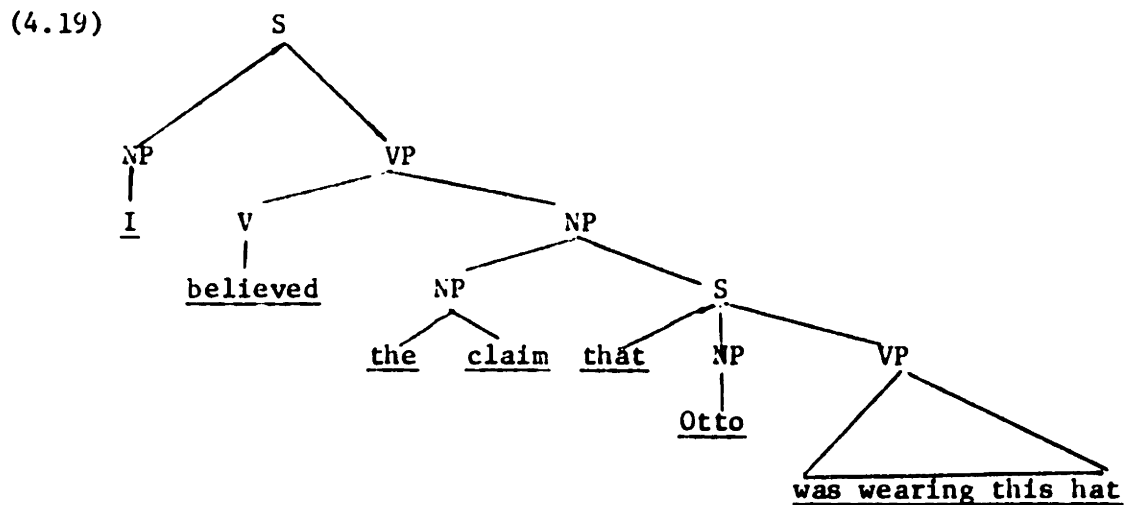

Whether or not we can show it to be correct that abstract nouns followed by sentential clauses in apposition to them have exactly the same $[NP\ S]_{NP}$ structure that we argue relative clauses have, it is clear that these constructions are highly similar. Condition (4.20), the Complex NP Constraint, is formulated in an effort to exploit this similarity to explain the ungrammaticality of sentences like (4.18a) and (4.15) on the same basis.

(4.20) The Complex NP Constraint

No element contained in a sentence dominated by a noun phrase with a lexical head noun may be moved out of that noun phrase by a transformation.

To put it diagrammatically, (4.20) prevents any constituent A from being reordered out of the S in constituents like the NP shown in (4.21),

(4.21)

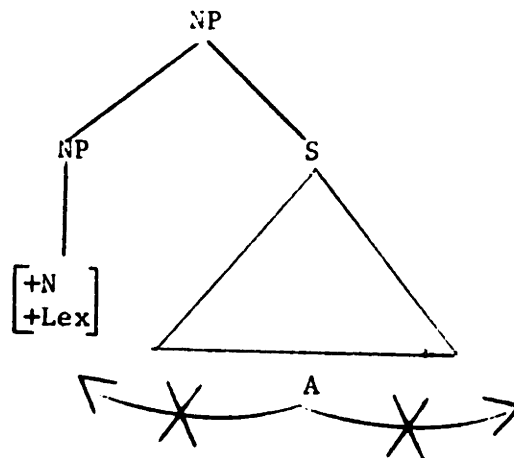

as the X's on the two arrows pointing left or right from A designate. (Note that (4.20) does not prohibit elements from reordering within the dominated sentence, and in fact, there are many rules which effect such reorderings. Some will be discussed in § 5.1 below.)

I have assumed the existence of a feature, [± Lex], to distinguish between lexical items like claim in (4.17a) or girl in (4.14) on the one hand, and the abstract pronoun it of (4.13a) on the other. Since it is possible to move elements out of sentences in construction with the third of these, as (4.13a) attests, but not out of sentences in construction with the first two ((4.18a) and (4.15) are ungrammatical), it will be necessary for the theory of grammar to keep them distinct somehow. The feature [± Lexical] may not turn out to be the correct one; I have chosen it not only on the basis of the facts just cited but also with regard to the following parallel case in Japanese.

4.1.4. In Japanese, and I believe in all other languages as well, no elements of a relative clause may be relativized. Japanese relative clauses invariably precede the noun they modify. Superficially, they appear to be formed by simply deleting the occurrence of the identical NP in the matrix sentence. Thus when the sentence (4.22) is embedded as a modifier onto the NP sono sakana wa 'this fish', which is the subject of (4.23), (4.24) results.

(4.22) kodomo ga⁴ sakana o tabete iru.
 child fish eating is
 'The child is eating the fish.'

(4.23) Sono sakana wa ookii.
 That fish big
 'That fish is big.'

(4.24) Sono kodomo ga tabete iru sakana wa ookii.
 That child eating is fish big
 'That fish which the child is eating is big.'

The deep structure of (4.24) is that shown in (4.25)⁵.

(4.25)

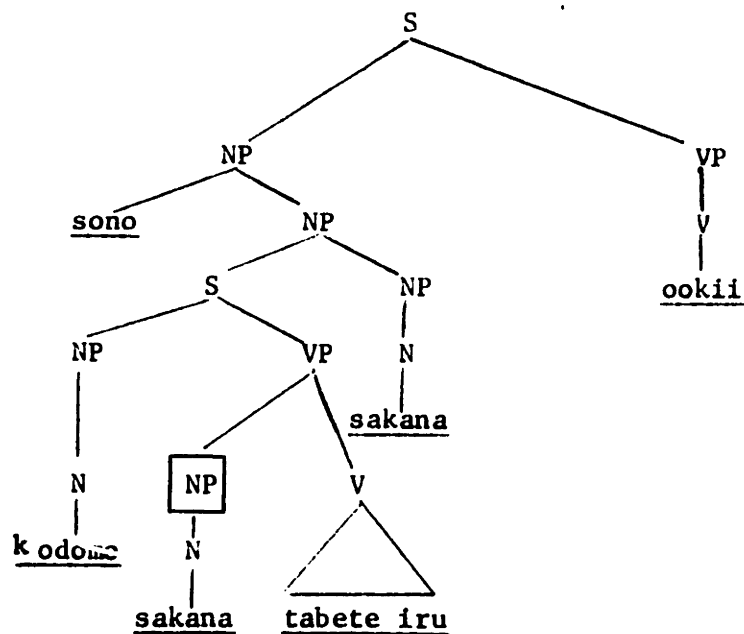

In the derivation of (4.24) from (4.25), when the Relative Clause Formation Rule applies, the only apparent change that occurs in (4.25) is that the boxed node NP disappears. It would thus appear that the English version of the Relative Clause Formation Rule, which was stated in (4.2), is fundamentally different from the Japanese version, for in the former, the embedded identical NP is reordered and placed at the front of the matrix sentence, while in Japanese, the embedded NP is merely deleted.

But there are two facts which lead me to believe that this dissimilarity is only superficial. First of all, the Japanese Relative Clause Formation Rule is subject to the Complex NP Constraint and also to the Coordinate Structure Constraint, which will be discussed in § 4.2, and I will show, in Chapter 6, that simple deletion transformations are not subject to these two conditions. Secondly, in Japanese, as in all other languages I know of, the crossover condition, which Postal has proposed, obtains.

This condition, as Postal originally stated it,⁶ prevents any transformation from interchanging two coreferential NP. Since the Passive Rule effects such an interchange, reflexive sentences cannot be passivized, as was noted by Lees and Klima (cf. Lees and Klima (1963)).

- (4.26) a. Rutherford understands himself.
 b. * Rutherford is understood by himself.
 c. * Himself is understood by Rutherford.

The condition can be generalized, however. Subjects of sentences which appear as the object of say can normally be relativized: that this is true of the NP pudding in (4.27a) can be seen from the grammaticality of (4.27b):

- (4.27) a. The man who ordered ice cream said the pudding_i would be tasty.
 b. The pudding which the man who ordered ice cream said would be tasty was a horror show.

But if (4.27a) is changed so that the coreferential NP the pudding_i appears not only as the subject of would be tasty but also as the deep object of ordered, and if backward pronominalization has applied, yielding (4.28),

- (4.28) The man who ordered it_i said the pudding_i would be tasty.

then, for many speakers, the subject NP of the embedded sentence is no longer relativizable.

- (4.29) * The pudding_i which the man who ordered it_i said would be tasty was a horror show.

While (4.29) is an acceptable sentence if the pronoun it refers to some other NP, it is ungrammatical if it has the same referent as the head noun of the subject of (4.29).

These facts can be explained by generalizing the cross-over condition as shown in (4.30):

(4.30) The Crossover Condition

No NP mentioned in the structural index of a transformation may be reordered by that rule in such a way as to cross over a coreferential NP.

This condition is strong enough to exclude (4.29), for in carrying out the Relative Clause Formation Rule to form (4.29), it would have been necessary to move the subject of would be tasty leftwards over the coreferential pronoun it. This also explains why the pronoun he in (4.31a) can refer to the same man as the head NP the man but cannot do so in (4.31b).

- (4.31) a. The man_i who said he_i was tall
 b. * The man_i who he_i said_i was tall

However, (4.30) is too strong -- it would incorrectly prevent (4.32a) from being passivized, and (4.32b) could not be generated.

- (4.32) a. The sheriff_i denied that gangsters had bribed him_i.
 b. That gangsters had bribed him_i was denied by the sheriff.

At present, I know of no way to weaken (4.30) to avoid this wrong result.

The crossover condition also obtains in Japanese: the Japanese version of the Passive Rule, which converts (4.33a) to (4.33b),

- (4.33) a. sono hito wa sakana o aratta.
 that man fish washed
 'That man washed the fish.'
- b. sakana wa sono hito ni arawareta.
 fish that man was washed
 'The fish was washed by the man.'

cannot apply to reflexive sentences. (4.34a) cannot be passivized, as the ungrammaticality of (4.34b) shows.

- (4.34) a. sono hito wa zibun o aratta.
 that man self washed
 'That man washed himself.'
- b. * zibun wa sono hito' ni arawareta.
 '* That man was washed by himself.'

The crossover condition, by its very nature, applies only to transformations which reorder constituents, so the fact that grammatical and ungrammatical pairs of Japanese relative clauses can be found which parallel those in (4.31) is a second indication that the Japanese rule of Relative Clause Formation also involves reordering, and not merely deletion.

- (4.35) a. kare_i ga nagai to itta hito_i
 he tall that said man
 'The man who said he was tall '

b. * hito_i ga nagai to itta hito_i
 man tall that said man

'* The man_i who he_i said was tall '

The fact that the first occurrence of hito 'man' in (4.35b) cannot have the same referent as the second one indicates that the term 'cross over', which was used in the statement of (4.30), cannot be taken simply to refer to the linear order of words in the sentence, for the underlying structure of (4.35a) is that shown in (4.36).

(4.36)

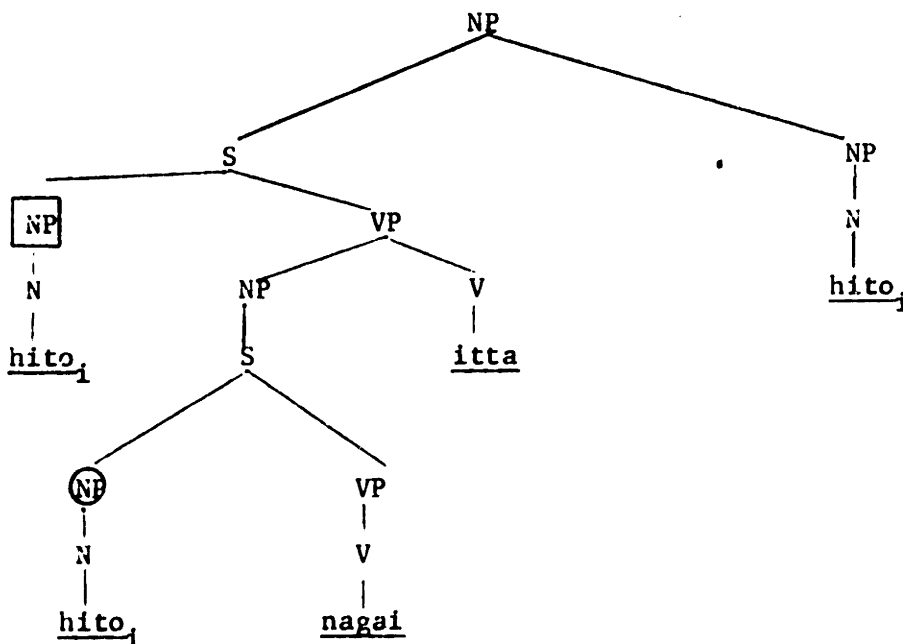

As (4.35) shows, the boxed NP can be relativized, although the circled NP cannot. If I am correct in attributing these facts to the cross over condition, which (4.34b) shows to be necessary in Japanese in any case, then, if the rule of Relative Clause Formation

in Japanese operates in such a way as to move the identical NP in the matrix sentence to the right end of the embedded sentence, in the opposite direction from that in which it moves in English⁷, the notion of "crossing over" must be defined in such a way as to take into consideration not only the one-dimensional linear ordering of constituents, but also their two-dimensional hierarchical arrangement.

At any rate, whether or not my contention that the Japanese version of Relative Clause Formation involves reordering is correct, it is a fact that elements of relative clauses cannot be relativized. For example, sentence (4.24), in which the NP kodomo ga 'the child' appears as the subject of a relative clause, cannot be embedded as a modifier of the subject NP of (4.37), as is shown by the ungrammaticality of (4.38).

(4.37) kodomo ga byooki da.

child sick is

'The child is sick.'

(4.38) * sono tabete iru sakana ga ookii kodomo ga byooki da.

that eating is fish big child sick is.

'* The child who that fish (he) is eating is big is sick.'

Furthermore, there are Japanese sentences like (4.39) which parallel those in (4.17); and, just as is the case in English, while elements can be relativized from the object clause of (4.39b), which corresponds to (4.17b), this is not possible in (4.39a), which corresponds to (4.17a). This can be seen from the ungrammaticality of (4.40a) and the grammaticality of (4.40b).

(4.39) a. Otto ga kono boosi o kabutte ita to iu syutyoo o watakusi wa sinzita.
 Otto this hat wearing was that say claim I believed
 'I believed the claim that Otto was wearing this hat.'

b. Otto ga kono boosi o kabutte ita koto o watakusi wa sinzita.
 Otto this hat wearing was thing I believed
 'I believed that Otto was wearing this hat.'

(4.40) a. *Otto ga kabutte ita to iu syutyoo o watakusi ga sinzita boosi wa akai.⁸
 Otto wearing was that say claim I believed hat red
 '*The hat which I believed the claim that Otto was wearing is red.'

b. Otto ga kabutte ita koto o watakusi ga sinzita boosi wa akai.
 Otto wearing was thing I . believed hat red
 'The hat which I believed that Otto was wearing is red.'

The underlying structure for (4.40b) is roughly that shown
 in (4.41).

(4.41)

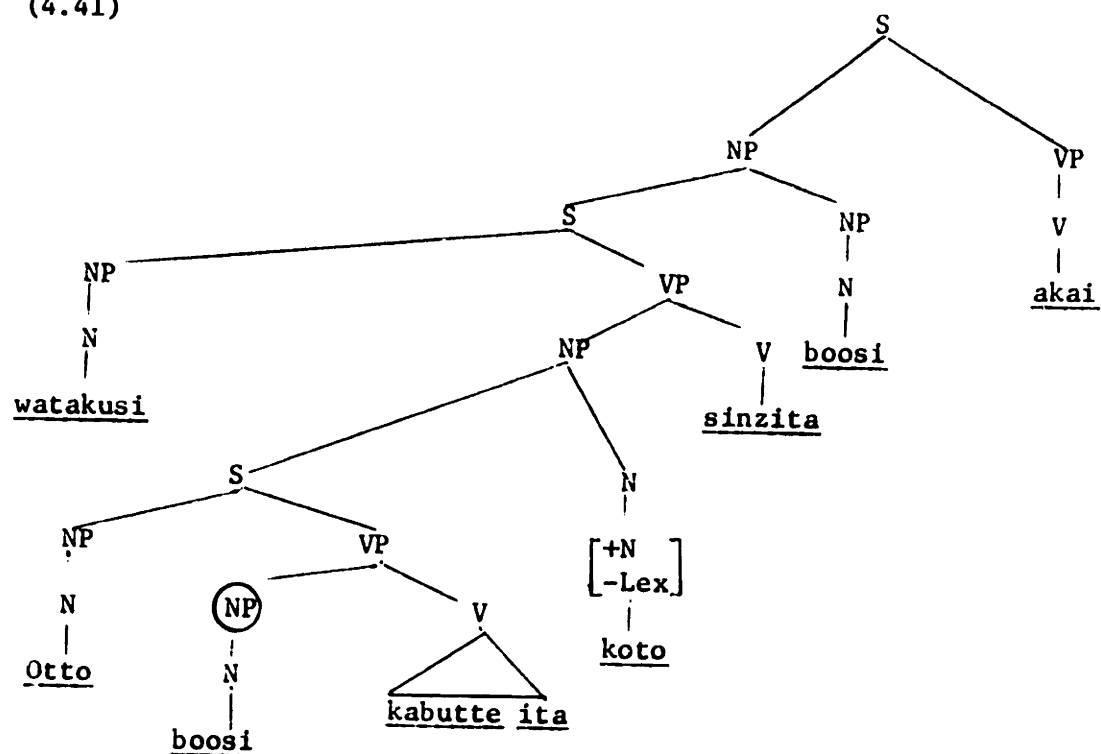

Although it is not clear to me what the deep structure for sentences like (4.39a) should be, it seems reasonable to assume that at the time the Relative Clause Formation Rule applies, the major difference between this structure and the structure which results from the deep structure of (4.39b) (the deep structure which appears in (4.41) as a relative clause on boosi 'hat') would be that the lexical noun syutyoo 'claim', would appear in place of the non-lexical noun koto 'thing'. Thus the circled NP boosi 'hat' in (4.41) is relativizable, because the Complex NP Constraint only prohibits elements which are contained in a sentence dominated by a

NP with a lexical head noun from reordering, and the Japanese nouns koto, mono, and no (if this last should be analyzed as a noun at all), which all mean roughly 'thing', are presumably non-lexical. But nouns like syutyoo 'claim' are lexical, and therefore the Complex NP Constraint must prevent elements of sentences in apposition to them from reordering out of these sentences, as the ungrammaticality of (4.40a) shows.

To summarize briefly, what I am proposing is that the facts presented as evidence for the A-over-A principle, in Cases A and B of § 2.2 - namely that elements of relative clauses cannot be relativized or questioned, and that in general, elements of clauses in apposition to sentential nouns also cannot -- should both be accounted for by (4.20) -- the Complex NP Constraint. The fact that elements of clauses in construction with "empty" nouns like it (cf. (4.13a)) and koto 'thing' (cf. (4.40b)) can be relativized, whereas this is not possible in clauses in construction with nouns like girl (cf. (4.15)), claim (cf. (4.18a)), kodomo 'child' (cf. (4.38)), and syutyoo 'claim' (cf. (4.40a)), necessitates that the constraint be stated with reference to some such feature as [\pm Lexical]. I believe the Complex NP Constraint to be universal (but cf. fn. 8), although there are problems with it even in English. These will be taken up in the two sections immediately following.

4.1.5. The first difficulty with (4.20) concerns sentences like those in (4.42).

- (4.42) a. I am making the claim that the company squandered the money.
- b. I am discussing the claim that the company squandered the money.

Most speakers find NP in the position of the money not to be relativizable in (4.42b), but to be so, or at least more nearly so, in the case of (4.42a).

- (4.43) a. ? The money which I am making the claim that the company squandered amounts to \$400,000.
- b. * The money which I am discussing the claim that the company squandered amounts to \$400,000.

Sentence (4.43b) can be made even more ungrammatical by prefixing the noun claim with some possessive modifier,

- (4.44) ** The money which I am discussing Sarah's claim that the company squandered amounts to \$400,000.

and many speakers feel that while (4.43a) may not be fully grammatical, sentences like those in (4.45), whose only significant difference from (4.43a) lies in the definiteness of the article on the sentential noun, are completely grammatical.

- (4.45) a. The money which I have $\left. \begin{array}{l} \text{hopes} \\ \text{a feeling} \end{array} \right\}$ that the
company will squander amounts to \$400,000.
- b. The money which I will have a chance to
squander amounts to \$400,000.
- c. The money which I will make a proposal
 $\left. \begin{array}{l} \text{for us to squander} \\ \text{that we squander} \end{array} \right\}$ amounts to \$400,000.

If any of these sentences are grammatical, either condition (4.20) must be modified or abandoned, or the two sentences in (4.42) must derive from quite different sources. As it stands, (4.20) will block the generation of all the sentences in (4.43) - (4.45): in each case, the NP being relativized is contained in a sentence in apposition to a lexical head noun.

There is some evidence that the second alternative may be correct, i.e., that (4.20) can be preserved as is. I have not yet been able to solve various problems of rule ordering that arise in connection with this alternative, and it is only in the hope that the following incomplete analysis may suggest a correct way of distinguishing between (4.43a) and (4.43b) that I present it here.

Harris has proposed (cf. Harris (1957)) that sentences like those in (4.46) be directly transformed into the corresponding sentences in (4.47), by a rule which he calls the modal transformation.

- (4.46) a. I snoozed.
 b. Sam progressed.
 c. Bill gave me \$40.
 d. Max shoved the car.
 e. I feel that Arch will show up.

- (4.47) a. I took a snooze
 b. Sam made progress.
 c. Bill made a gift to me of \$40.
 d. Max gave the car a shove.
 e. I have a feeling that Arch will show up.

Since the surface structures of (4.46a) and (4.47a) seem to be those shown in (4.48a) and (4.48b), respectively (the situation is similar with respect to the other sentences of (4.46) and (4.47)),

(4.48) a.

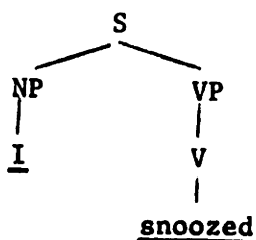

b.

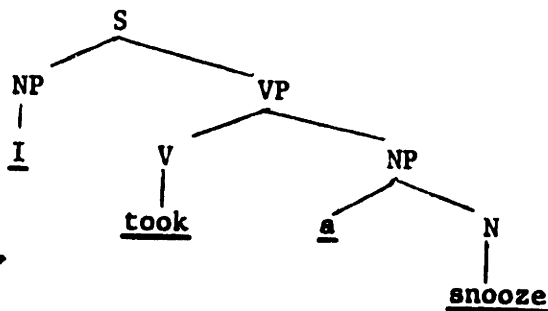

Harris' rule cannot be stated within the currently available theoretical framework, for at present, only transformations which decrease structure can be formulated. The P-marker in (4.48a) contains only one NP, but the one in (4.48b) contains two, so the present theory would not allow a direct transformational relation which converted the former into the latter (the opposite direction would be possible, of course). So, at present, in the theory of generative grammar, one could only claim (a) that the sentences are only semantically related, or (b) that (4.48b) is converted into (4.48a), or (c) that the deep structure of (4.48a) is contained in the deep structure of (4.48b), as shown in (4.49):

(4.49)

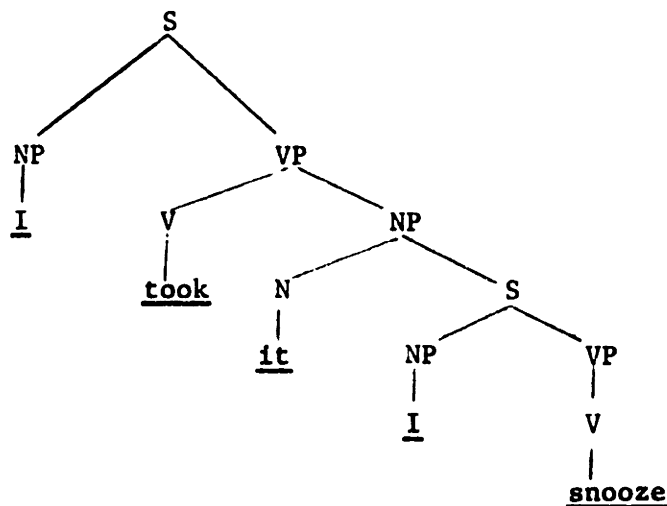

Proponents of this last approach would presumably argue that after the embedded subject in (4.49), I, had been deleted by Equi-NP Deletion, the verb snooze would be substituted for the

abstract pronoun, it, and the indefinite article would be segmentalized⁹, yielding the structure in (4.48b).

I do not know whether any of the above analyses is correct, or whether structure-building transformations, which could convert (4.48a) directly into (4.48b), should be countenanced within the theory. But whatever analysis is adopted for the sentences in (4.47), it should also be adopted for expressions like make the claim that S, have hopes that S, have a chance to VP, etc., which were used in (4.42) and (4.45) above. If analysis (a) is correct, then both sentences in (4.42) would come from roughly the same deep structure, (4.50).

(4.50)

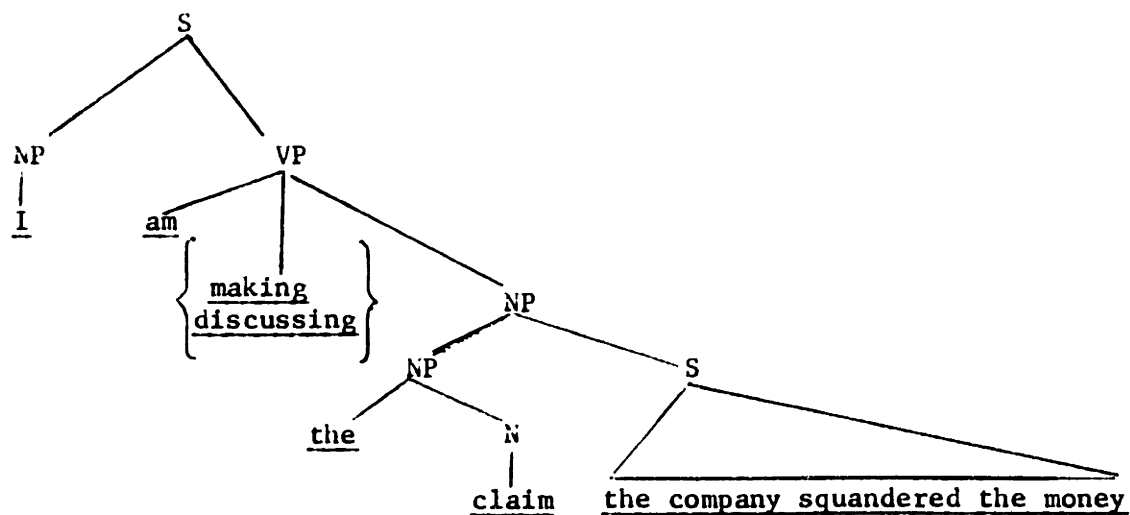

But the fact that the NP the money is relativizable in (4.42a) but not in (4.42b) seems to argue against this analysis, for how can this difference be accounted for, if both sentences have roughly the same deep structure? Furthermore, there is another fact about the sentences in (4.42a) and (4.45a) which sets them off from other sentences containing sentential nouns with clauses in apposition to them. George Lakoff has pointed out to me that the rule which optionally deletes the complementizer that in clauses which follow a verb cannot apply if the verb has been substantivized. So, while both (4.51a) and (4.51b) are grammatical, only the a-version of (4.52) is possible.

- (4.51) a. Kleene proved that this set is recursive.
 b. Kleene proved this set is recursive.

- (4.52) a. The proof that this set is recursive is difficult.

- b. * The proof this set is recursive is difficult.

It seems to be the case that it is only in modal constructions like make the claim that S, have hopes that S, etc. that the complementizer that can be deleted after a sentential noun.

- (4.53) a. ? I am making the claim the company squandered the money.
 b. I have hopes the company will squander the money.

c. I have a feeling the company will squander
the money.

d. * I made a proposal we squander the money.

As (4.53d) shows, it does not seem to be the case that that can be deleted in all modal constructions -- what the restrictions are I do not know at present -- but the fact that it generally can be deleted in these constructions is another piece of evidence that argues they should be analyzed differently than such sentences as (4.42b).

One final fact deserves mention here: to the best of my knowledge, it is only in modal constructions that sentential nouns which are related to transitive verbs cannot occur with a full range or possessive modifiers. In sentences like those in (4.54), where the main verb of the sentence containing claim is not make, any possessive NP can modify claim.

- (4.54) a. $\left\{ \begin{array}{l} \text{Your} \\ \text{Dick's} \\ \text{etc.} \end{array} \right\}$ claim that semantics is generative
is preposterous.
- b. We are discussing $\left\{ \begin{array}{l} \text{Myron's} \\ \text{their} \\ \text{etc.} \end{array} \right\}$ claim that
flying saucers are real.

But after the verb make, and only after it, the possessive modifier must refer back to the subject of make, if it is possible to have such a modifier at all:

- (4.55) Myron is making $\left. \begin{array}{l} \text{the} \\ ? \text{ his} \\ * \text{ Suzie's} \\ * \text{ Dr. No's} \\ \text{etc.} \end{array} \right\}$ claim that dead
is better than red.

The same is true of all modals, as the sentences in (4.56) demonstrate.

- (4.56) a. * I have Tom's feeling that the company will squander the money.
b. * Myra took Betty's snooze.
c. * Bill made Sarah's gift to me of \$40.
d. * Max gave the car Levi's shove.

These three facts -- that the Complex NP Constraint is not operative in modal constructions, that the complementizer that is generally deletable there, and the fact that possessive modifiers must refer back to the subject of the modal verb -- indicate clearly that sentential nouns like claim, hope, etc. which occur in these constructions must be derived differently in modal constructions than they are elsewhere.

It is tempting to propose changing the theory so that (4.48a) could be directly converted into (4.48b) by a structure-building

rule of Modalization. Then the fact that elements are relativizable in complement sentences after make the claim, have hopes, etc. and the fact that that can be deleted there could be handled by ordering the rules as follows: Relative Clause Formation, That Deletion, Modalization.

Unfortunately, this solution will not work, for if there is a rule of Modalization, Passive must follow it:

(4.57) The claim that plutonium would not float was made by the freshman.

But if Passive follows Relative Clause Formation, such sentences as (4.58) will not be derivable.

(4.58) The man who was arrested by Officer McNulty went mad.

Furthermore, if Passive follows That Deletion, what is to prevent derivations like that shown in (4.59)?

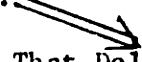
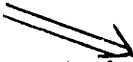
- (4.59) a. Jack is claiming that you won't need it.  That Deletion
- b. Jack is claiming you won't need it.  Modalization
- c. Jack is making the claim you won't need it. \implies Passive
- d. * The claim you won't need it is being made by Jack.

These difficulties, which I have not been able to overcome, have kept me from reaching a solution to the problem posed by the modal construction for the Complex NP Constraint. But since it seems clear that the complex sentential NP which occur in modal constructions must be derived from some other source than the sentential NP in other constructions, I have hopes that it will be possible to preserve the Complex NP Constraint in the way it was stated in (4.20). At any rate, I will not settle for merely an ad hoc rider on (4.20) until the grammar of modal constructions is considerably better understood than it is at present.

4.1.6. The second difficulty concerning (4.20) arises in connection with the sentences in (4.3) and (4.4), which I will repeat below for convenience.

- (4.3) a. I read a statement which was about that man.
 b. I read a statement about that man.

- (4.4) a. * The man who I read a statement which was
 about is sick.
 b. The man who I read a statement about is sick.

As I pointed out in § 4.1.2, it is not in general the case that elements in reduced relative clauses can be relativized or questioned: the fact that the sentences of (4.15) and (4.16) are equally ungrammatical supports this contention. How then can it be that the object of about in (4.3b) can be relativized, if (4.3b) derives

from (4.3a) by way of the rule of Relative Clause Reduction?

The tentative answer to this question which I would propose is that the relation between the sentences of (4.3) must be much more complex than has hitherto been suspected. I suspect that (4.3b) is nearer to being basic than (4.3a) is, and that in any case, (4.3b) is not derived from (4.3a) by means of the rule of Relative Clause Reduction. There are a number of peculiar facts about sentences containing nouns like statement, some of which I will take up below, which suggest the correctness of this idea.

First of all, such sentences behave uniquely under reflexivization. As was shown in Lees and Klima (1963), the second of two identical noun phrases is replaced by a reflexive pronoun, subject to the condition that both NP's be in the same "simplex sentence", to use their term. They do not state how this restriction is to be expressed formally, but their meaning will be clear from the following examples:

- (4.60) a. You're going to hurt yourself one of these days.
 b. I spoke to Bill about himself.
- (4.61) a. * That Tom saw me surprised myself.
 b. * He said that himself was hungry.

Reflexivization must be blocked in (4.61), for in both cases, there is a node S which dominates one occurrence of the two NP's which does not dominate the other. Since this is not true of

(4.60), Reflexivization must apply.

Consider now such sentences as those shown in (4.62)

- (4.62) a. I read him_i a statement which was about
 $\left. \begin{array}{l} him_i \\ ?himself \end{array} \right\}_i$.
- b. I read him_i a statement about $\left. \begin{array}{l} *him_i \\ himself \end{array} \right\}$.

I am not sure, but I believe (4.62a) is better, in my own speech, with a non-reflexive pronoun than with a reflexive pronoun. If there are dialects in which both of the sentences in (4.62a) are fully grammatical, I can provide no explanation of such facts, for in the overwhelming majority of cases, Reflexivization cannot go down into relative clauses, and I would not know how to characterize formally the relative clauses in sentences like (4.62a) in such a way that Reflexivization could go down into them, but not into clauses like the one shown in (4.63).

- (4.63) I know a man who hates $\left. \begin{array}{l} me \\ *myself \end{array} \right\}$.

Therefore, for the purposes of this study, let us assume, perhaps falsely, the existence of a dialect in which reflexive pronouns are absolutely excluded in (4.62a) and are absolutely necessary in (4.62b). How could we explain such facts?

Given that a meta-rule of S-pruning like (3.6) must be included in linguistic theory, on the basis of the independent evidence presented in § 3.1, it might be argued that the explanation

must depend in some way on this meta-rule. That is, one could assume that (4.62b) is derived from (4.62a) by the rule of Relative Clause Reduction. Reflexivization would be blocked in (4.62a), because in (4.64), which shows the approximate structure of (4.62a), the circled node S dominates the second occurrence of the NP he (him), but not the first, so the two NP's are not in the same simplex sentence.

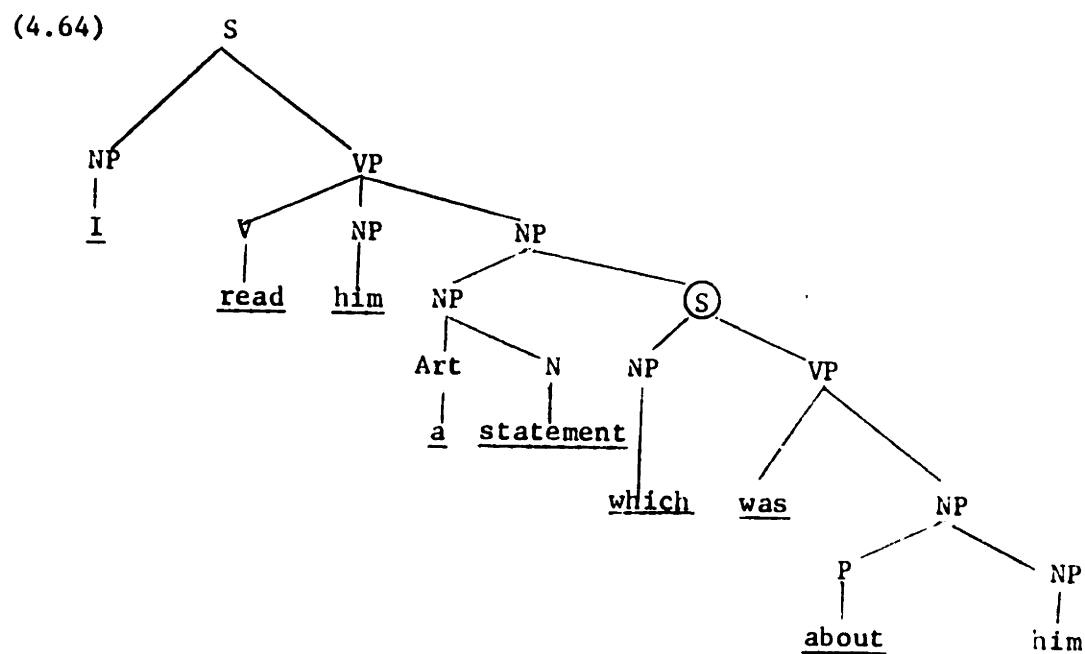

Then, of course, as in the cases discussed in §§ 3.1.1 - 3.1.3, when the Relative Clause Reduction Rule deletes which was in (4.64), the circled S will no longer branch and will be pruned by (3.6), thus bringing it about that the two occurrences of he (him) are in the same simplex sentence, so that Reflexivization can convert the second one into himself.

This proposal may seem appealing at first glance, but closer scrutiny reveals that it is inadequate in a number of serious ways, and cannot, as far as I can see at present, be patched up to overcome these inadequacies. The first difficulty arises in connection with several facts which were first pointed out in two careful studies of reflexives made by Florence Warshawsky (cf. Warshawsky (1965a,b)). She pointed out that whether or not reflexivization occurs in sentences like (4.62b) is correlated in some inexplicable way with the type of determiner which precedes statement. In (4.65a), where the determiners are indefinite, reflexivization seems to be obligatory, in most dialects, whereas in (4.65b), where the determiners are possessives, they do not occur (in most dialects). With the definite articles the, this, that (4.65c), there seems to be great dialectal variation. To my ear, the sentences sound odd with or without reflexives.

- (4.65) a. I read him two (several, some, no)
statements about himself.
- b. * I read him Judy's statement about himself.
- c.?* I read him the (this, that) statement
about himself.

Clearly, no principle like (3.6) can account for the facts in (4.65) by itself -- additional conditions of some sort must be imposed on the rule of Reflexivization (these sentences will be discussed again in § 6.4) below). But, it might be argued, at least the principle of

S-pruning makes it possible to state the Reflexivization Rule in such a way that reflexives are excluded from (4.62a), while at least some of them are allowed in sentences like (4.65a) and possibly (4.65c). This argument seems appealing until it is realized that normally Reflexivization does not go down into reduced relative clauses. For example, if the relative clause in (4.66a) is reduced to the phrase behind me, the NP me cannot be converted into a reflexive. The same is true of the reduced clauses jealous of you and watching me in (4.77b) and (4.78b).

- (4.66) a. I know two men who are behind me.
 b. I know two men behind me (*myself).
- (4.67) a. You are too flip with people who are jealous
 of you.
 b. You are too flip with people jealous of
 you (*yourself).
- (4.68) a. I screamed at some children who were
 watching me.
 b. I screamed at some children watching me
 (*myself).

In fact, excluding the problem as to whether reflexive pronouns can appear in relative clauses of the type contained in (4.62a), I would hazard a guess that not only do rules of reflexivization universally not go down into relative clauses, they also do not go down into reduced relative clauses. For instance, in German, if the

relative clause die ihm lieb sind 'who are kind to him' in (4.69a) is reduced to form (4.69b), the personal pronoun ihm 'him' (dat.) is not converted to the reflexive pronoun sich 'himself'.

(4.69) a. Hans verknallt sich nur in Mädchen, die
Hans falls only for girls, who
ihm lieb sind.
him kind are.

'Hans only falls for girls who are kind to him.'

b. Hans verknallt sich nur in ihm liebe Mädchen.
Hans falls only for him kind girls.

'Hans only falls for girls kind to him.'

If sich is substituted for ihm in (4.69b), as in (4.70), the sentence produced has a different meaning and is unrelated to the sentences in (4.69).

(4.70) Hans verknallt sich nur in sich liebe Mädchen.
Hans falls only for themselves kind girls.

'Hans only falls for girls who are kind to themselves.'

Thus, the most obvious explanation of the facts of (4.62), an explanation making use of the rule ordering shown in (4.71)

(4.71) Relative Clause Reduction

Reflexivization

and of some convention of S-pruning, would seem to be inadequate for the same reason that (4.5) cannot adequately account for the difference in grammaticality of the sentences in (4.4). Normally,

Reflexivization does not go down into reduced relative clauses, so the fact that reflexives can occur after about in (4.62b) suggests that the about-phrase is not clausal in origin.

Warshawsky (op. cit.) points out that many of the nouns which can appear in the blank in (4.72) are related to verbs.

(4.72) Max showed me a _____ $\left. \begin{array}{l} \text{of} \\ \text{about} \end{array} \right\}$ himself.

A few of the verb-related nouns that occur in this environment are listed in (4.73a); several for which no corresponding verb exists are given in (4.73b). (Warshawsky gives much more extensive lists of these nouns, which she calls "picture nouns".)

- (4.73) a. description, statement, report, claim,
tale, drawing, painting, photograph,
etching, sketch
- b. story, column, satire, book, letter, text,
article, sentence, paragraph, chapter,
picture

Warshawsky points out that the verbs associated with the nouns of (4.73a) are all verbs of creation, and the nouns systematically ambiguous with respect to whether they denote an abstract creation or some physical object upon which this creation is represented. Further, she notes that certain of these verbs can occur only with human subjects (cf. (4.74)),

(4.74) { Michael
*Michael's photograph } { painted
sketched
drew } the duck
pond.

but that others could have either human subjects or picture noun
subjects.

(4.75) { Michael
Michael's } { report
statement
description
story
article
book
?picture } { told of the conflict
described the country
stated that we were at fault }.

This last property is unlike any other grammatical fact I have encountered. It is worth pointing out that it is not the case that any abstract noun can serve as subject of these verbs -- only picture nouns can, as is shown by the ungrammaticality of (4.76).

(4.76) { the space between my eyes
sentencehood
*Harry's civil rights
Marilyn's arrival
etc. } { told of the conflict
described the country
stated that we were at fault }.

The fact that the deverbal nouns in (4.73a) behave the same way as the apparently basic nouns in (4.73b) with respect to relativization and questioning (cf. (4.4)), reflexivization (cf. (4.62)) and with respect to the curious selectional facts pointed out in (4.75)

provides strong evidence for treating all picture nouns alike. Warshawsky suggests that verbs may be basic for picture nouns, and that hypothetical verbs (cf. Lakoff (1965)) such as to story, to column, etc. be postulated as underlying the nouns of (4.73b). This proposal seems quite reasonable, but in the absence of a detailed analysis along these lines, little more can be said about it at present.

In passing, it should be remarked that there are a number of prepositional phrase adjuncts to noun phrases which exhibit similar behavior to picture nouns. As (4.16b) shows, it is not in general the case that elements of postnominal prepositional phrases can be questioned. But this is the case in the sentences of (4.77), as (4.78) shows.

- (4.77) a. I gave Tom a key $\left\{ \begin{array}{l} \text{to} \\ \text{for} \end{array} \right\}$ that door.
 b. Harold has books by some young novelists.
 c. Billy is looking for a road into the cavern.
- (4.78) a. Which door did I give Tom a key $\left\{ \begin{array}{l} \text{to} \\ \text{for} \end{array} \right\}$?
 b. Which novelists does Harold have books by?
 c. ? Which cavern is Billy looking for a road into?

Considerations of the same sort as were discussed above would suggest that NP like a key to this door and a road into the cavern should not be derived from ?a key which is to this door and ?a road which is into the cavern, which are at best of dubious grammaticality in any event. But what their deep structures might be

is at present an unsolved problem.

4.1.7. To conclude this discussion, the constraint which I stated in (4.20) correctly prevents elements of relative clauses from being questioned or relativized. The remarks of footnote 8 and § 4.1.5 above indicate that this constraint is stated too strongly at present, and the remarks in § 4.1.6 show that the differences between the sentences of (4.4), although they appear to fall within the scope of (4.20), are in fact much more complex than has been realized. I know of no other counterexamples to the Complex NP Constraint, and I therefore submit it for inclusion in the list of putative linguistic universals, subject to whatever modifications are necessary to avoid the extra strength pointed out in footnote 8 and § 4.1.5.

4.2. The Coordinate Structure Constraint

4.2.1. In § 2.2, in Case F, it was pointed out that conjoined NP cannot be questioned: this was attested to by the ungrammaticality of (2.18) and (2.19), which I repeat here for convenience.

(2.18) * What sofa will he put the chair between some
table and?

(2.19) * What table will he put the chair between and
some sofa?

The impossibility of questioning the circled NP nodes in diagram (4.79) can be successfully accounted for by invoking the A-over-A principle,

(4.79)

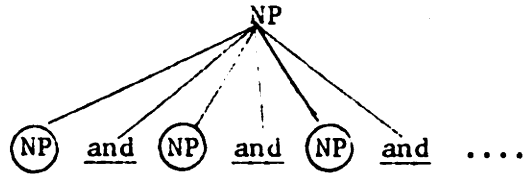

but this principle does not prevent the circled NP nodes in diagrams (4.80) or (4.81) from being questioned or relativized.

(4.80)

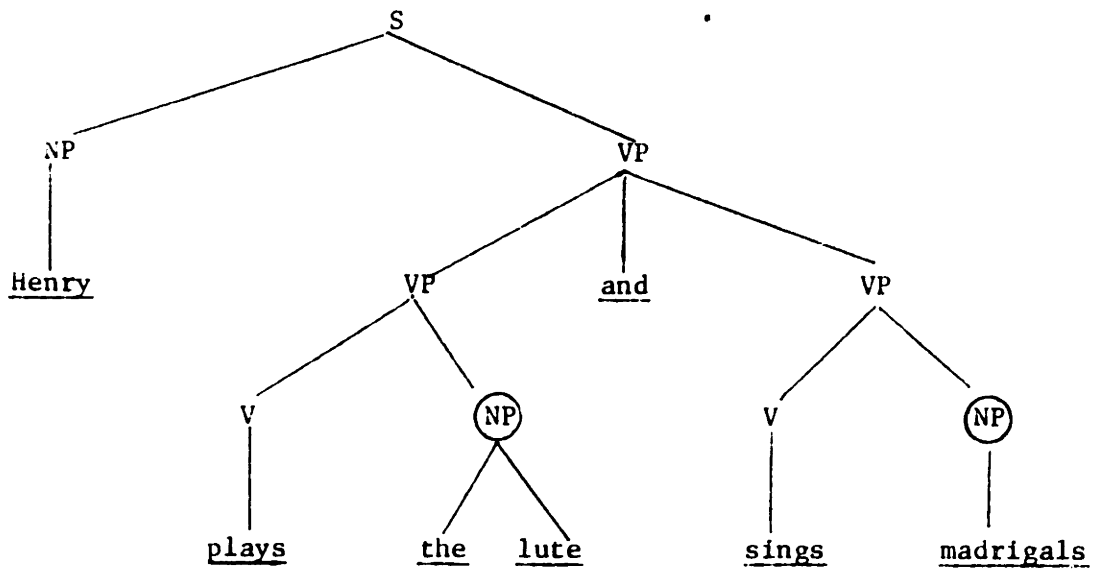

(4.81)

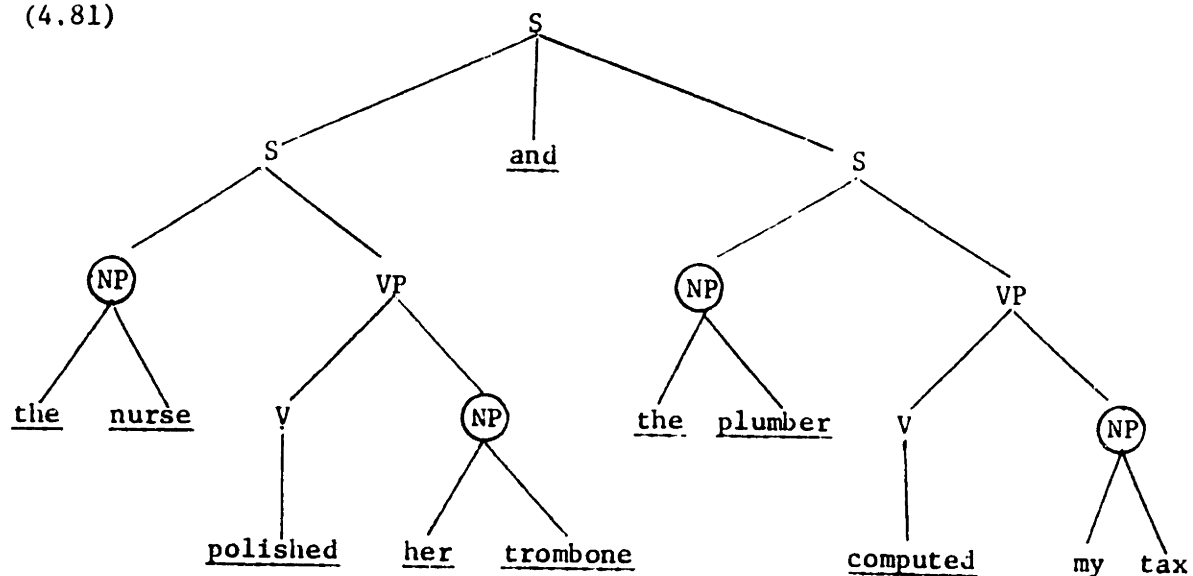

But all of the circled nodes must somehow be restricted from being moved, as the ungrammatical sentences of (4.82) show.

- (4.82) a. * The lute which Henry plays and sings
 madrigals is warped.
- b. * The madrigals which Henry plays the lute
 and sings sound lousy.
- c. * The nurse who polished her trombone and
 the plumber computed my tax was a blonde.
- d. * Which trombone did the nurse polish and
 the plumber computed my tax?
- e. * The plumber who the nurse polished her
 trombone and computed my tax was a hefty
 fellow.
- f. * Whose tax did the nurse polish her trombone
 and the plumber compute?

I know of no principled way of excluding such structures as those shown in (4.80) and (4.81) from being introduced as relative clauses, i.e., at the node S in (4.83),

(4.83)

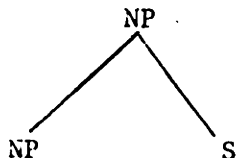

so it appears to be necessary to add the following constraint to the meta-theory:

(4.84) The Coordinate Structure Constraint

In a coordinate structure, no conjunct may be moved, nor may any element contained in a conjunct be moved out of that conjunct.

4.2.2. I propose to define the notion coordinate structure as any structure conforming to the schematic diagram in (4.85).

(4.85)

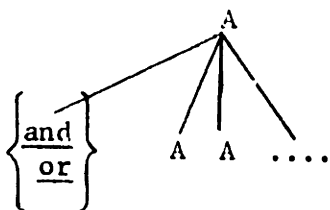

Of course, since (4.85) is intended to be a universal definition, it must be understood as containing not the English morphemes and and or, but rather a more abstract, language-independent representation of these terms¹⁰. Furthermore, the conjunction should be understood as either preceding all its conjuncts, as in English, French, etc., or as following them, as in Japanese. Coordinate structures contain at least two conjuncts, but may contain any higher number of them.

As for the deep structure position of the conjunction with respect to the conjuncts, there are many reasons for believing that the structure of (4.86) is not that shown in (4.87), but rather that shown in (4.88), where each occurrence of the conjunction and forms a constituent with the following sentence instead of being coordinate with it, as in (4.87).

(4.86) Irma washed the dishes, and Sally dried, and
Floyd loafed.

(4.87)

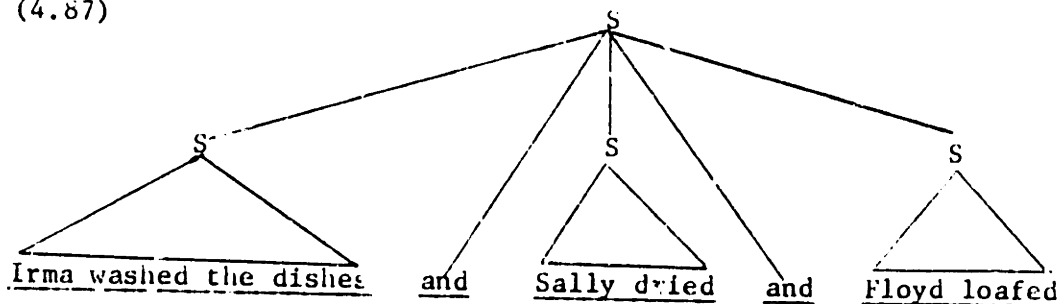

(4.88)

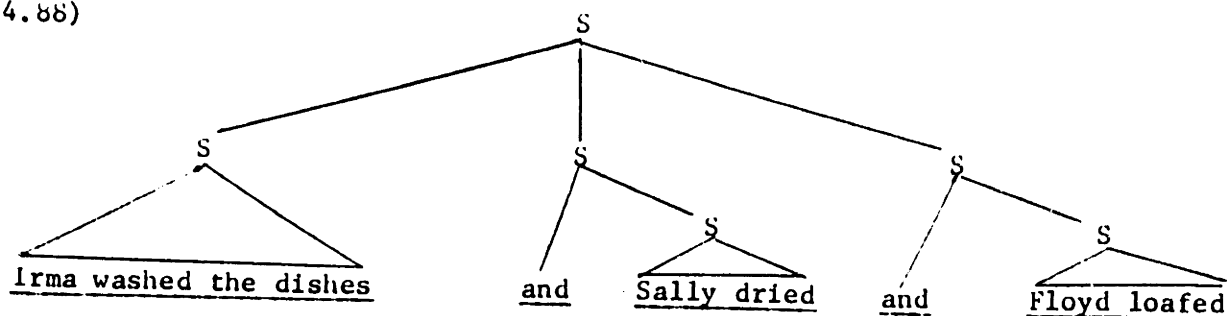

One syntactic reason is that if a conjoined sentence like (4.89) is broken up into two sentences, as in (4.90), the conjunction always goes with the second sentence, as in (4.90a), never with the first, as in (4.90b).

(4.89) John left, and he didn't even say goodbye.

(4.90) a. John left. And he didn't even say goodbye.

b. * John left and. He didn't even say goodbye.

A second syntactic reason is in that languages in which coordinating conjunctions can become enclitics, which are then inserted into one conjunct (this is the case with que 'and' in Latin, and with the word aber 'but' in German), these enclitics are always associated with the following conjunct, never with the preceding one. Thus (4.91) may be converted into (4.92a), but not into (4.92b).

(4.91) Sie will tanzen, aber ich will nach Hause gehen.

'She wants to dance, but I want to go home.'

- (4.92) a. Sie will tanzen; ich will aber nach Hause
gehen.
- b. * Sie will aber tanzen; ich will nach Hause
gehen.¹¹

A third syntactic reason for regarding (4.88) as the correct structure is the following: since the Appositive Clause Formation Rule must convert sentences like (4.93a) into (4.93b), (but cf. §6.2.4.1

- (4.93) a. Even Harold failed, and he is the smartest
boy in our class.
- b. Even Harold, $\left. \begin{array}{l} \text{and he} \\ \text{who} \end{array} \right\}$ is the smartest boy
in our class, failed.

there are very general theoretical grounds for arguing that the string and he is the smartest boy in our class in (4.93a) is a constituent, for except for this case, transformations can be constrained so that only constituents may be adjoined.

Phonological evidence indicates strongly that the bracketing of the subject NP of (4.94) must be that shown in (4.95a), and not that shown in (4.95b) or (4.95c),

- (4.94) Tom, and Dick, and Harry all love watermelon.
- (4.95) a. ((Tom) (and Dick) (and Harry)) all love
watermelon.
- b. ((Tom) (and) (Dick) (and) (Harry)) all
love watermelon.

- c. ((Tom and) (Dick and) (Harry)) all love watermelon.

for intonational pauses come before coordinating conjunctions, not after them or equally on both sides of them.

So there is good evidence to indicate that the correct structure of (4.86) must be that given in (4.88). But how does this structure arise? Lakoff and I (op. cit.) propose that there be a phrase structure rule schema like (4.96) in the base,

$$(4.96) \quad S \rightarrow \left\{ \begin{array}{l} \underline{\text{and}} \\ \underline{\text{or}} \end{array} \right\} S^n, \text{ where } n \geq 2$$

and that later the and or or which is introduced by (4.96) be copied and Chomsky-adjoined¹² to each of the indefinitely many S's that are introduced by (4.96) by a rule of Conjunction Copying. So the deep structure of (4.86) would be approximately that shown in (4.97), which the rule of Conjunction Copying will convert to (4.98).

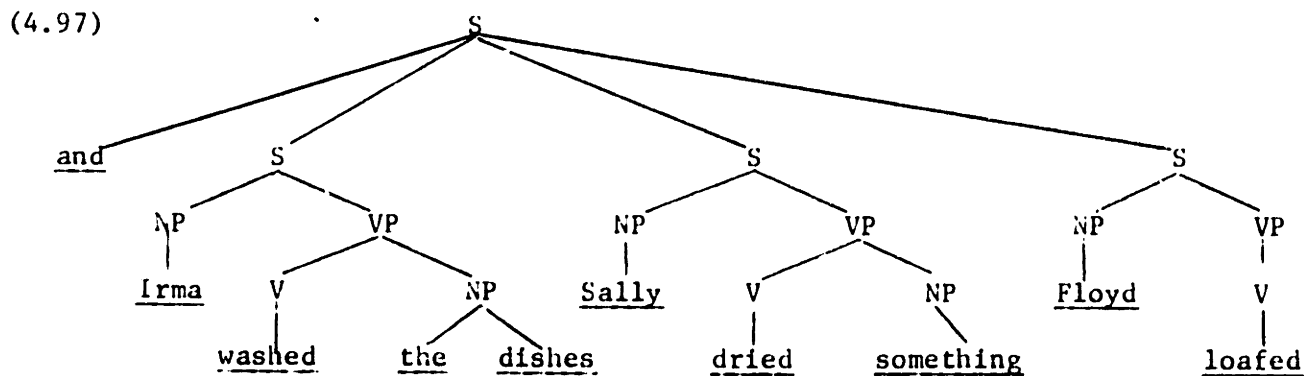

(4.98)

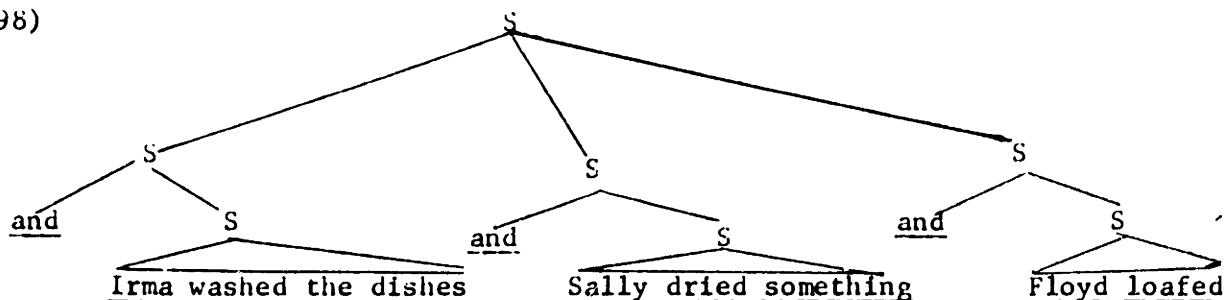

To derive (4.88) from (4.98), the first instance of and is deleted by a general rule which I will not state here. It is deleted obligatorily if the conjuncts are sentences, as is the case in (4.98), but it may optionally be converted into both if the conjuncts are NP, VP, or V. The rules for conjunction with or are similar in all respects, except that the initial or may be converted into either in front of all conjuncts. Languages like French, where the first conjunction does not have a suppletive alternant, provide further motivation for this analysis:

- (4.99) a. Et Jean et Pierre sont fatigués.
 andJohn and Peter are tired.
 'Both John and Peter are tired.'
- b. Ou Jean ou Pierre doit le faire.
 Or John or Peter must it do.
 'Either John or Peter must do it.'

One final point in favor of this analysis should be mentioned: the semantic interpretation of conjunctions, under this analysis, is much more in line with the traditional logical analysis of

conjunctions, which treats them as n-place predicates, than would be the case if the previously accepted analyses were adopted. That is, if (4.97) is adopted as the deep structure of (4.86), the conjunctions and and or are only different semantically from such two-place relations as see, etc. in that the former can have an indefinitely large number of arguments, while the latter is binary. But if some such structure as (4.87) is postulated as the deep structure of (4.86), quite dissimilar projection rules will have to be constructed to interpret (4.87) semantically, and the fact that and, or, and see are semantically similar, in that all are relations, will not be expressed formally.

4.2.3. Given the above definition of coordinate structure, the first clause of the Coordinate Structure Constraint will exclude (2.18) and (2.19), while the second will exclude all the sentences of (4.82). The latter sentences could neither be excluded by the A-over-A principle nor by the Complex NP Constraint of § 4.1, so it appears that condition (4.84) is necessary for reasons which are independent of the problems raised by (2.18) and (2.19). Thus (4.84) can be used to explain their ungrammaticality, just as the A-over-A principle was.

It should be pointed out that there are instances of the morpheme and which must be derived from different sources than the two major sources discussed in Lakoff and Peters (1966). For

instance, as (4.101) shows, there is a difference in relativizability between (4.100a) and (4.100b), even though both sentences in (4.100) appear to contain structures that are coordinate, by definition (4.85).

- (4.100) a. I went to the store and bought some whisky.
 b. I went to the store and Mike bought some whisky.
- (4.101) a. Here's the whisky which I went to the store and bought.
 b. * Here's the whisky which I went to the store and Mike bought.

However, as George Lakoff has pointed out to me, there are clear syntactic indications that the relative clause in (4.101a) is not an instance of ordinary sentence conjunction. First of all, it is only with non-stative verbs as the main verb of the second conjunct that sentences like (4.101a) can be constructed.

- (4.102) a. Tony has a Fiat and yearns for a tall nurse.
 b. * The tall nurse who Tony has a Fiat and yearns for is cruel to him.

Secondly, the second conjunct cannot be negative:

- (4.103) a. I went to the movies and didn't pick up the shirts.
 b. * The shirts which I went to the movies and didn't pick up will cost us a lot of money.

Thirdly, there are restrictions on the tenses that may appear in such sentences as (4.101a). Thus (4.104a) parallels (4.100a) in everything but tense, but the NP the whisky is not relativizable as (4.104b) indicates.

- (4.104) a. I went to the store and have bought some excellent whisky.
- b. * The excellent whisky which I went to the store and have bought was very costly.

The fact that (4.100a), on one reading, is synonymous with (4.105a), which contains a purpose clause, and the fact that the ungrammaticality of (4.102b), (4.103b), and (4.104b) is matched by correspondingly ungrammatical purpose clauses (cf. (4.105b), (4.105c), and (4.105d) respectively) suggests that the reading of (4.100a) which allows the formation of the relative clause of (4.101a) be derived from whatever the underlying structure is that underlies (4.105a). Note, by the way, that relativization is also possible in (4.105a), as (4.106) shows.

- (4.105) a. I went to the store to buy some whisky.
- b. * Tony has a Fiat to yearn for a tall nurse.
- c. * I went to the movies $\left. \begin{array}{l} \text{not to} \\ \text{to not} \end{array} \right\}$ pick the shirts up.
- d. * I went to the store to have bought some whisky.

- (4.106) Here's the whisky which I went to the store to buy.

There are other instances of the morpheme and which a similar line of argument suggests should not be derived from coordinate nodes in deep structure. For example, consider the sentences in (4.107):

- (4.107) a. She's gone and ruined her dress now.
 b. I've got to try and find that screw.
 c. Aunt Hattie wants you to be nice and kiss your granny.

As I have no plausible analysis for these sentences, I will merely point out that they are not subject to (4.84):

- (4.108) a. Which dress has she gone, and ruined now?
 b. The screw which I've got to try and find holds the frammiss to the myolator.
 c. Which granny does Aunt Hattie want me to be nice and kiss?

The fact that the sentences of (4.108) and sentence (4.101a) are grammatical might mean that (4.84) is simply wrong, but the facts I presented in (4.102) - (4.106) suggest that this may not be so, at least with regard to (4.101a). Rather it may be the case that none of these sentences contain coordinate structures at the time when questions, relative clauses, etc. are formed, but only are converted into coordinate structures later, or that they never contain coordinate structures at all. In fact, I know of no other test for coordinate

structure than the one (4.84) provides, and it therefore seems quite reasonable to me to assume that one of the last two possibilities mentioned above is correct.

It is perhaps worthwhile to show how (4.84) can provide a test for coordinate structure. (4.109a) can be converted into (4.109b) by the rule of Gapping (Ross 1967d):

- (4.109) a. The boy works in a skyscraper and the girl works in a quonset hut.
 b. The boy works in a skyscraper and the girl in a quonset hut.

The structure underlying these sentences is that shown in (4.110).

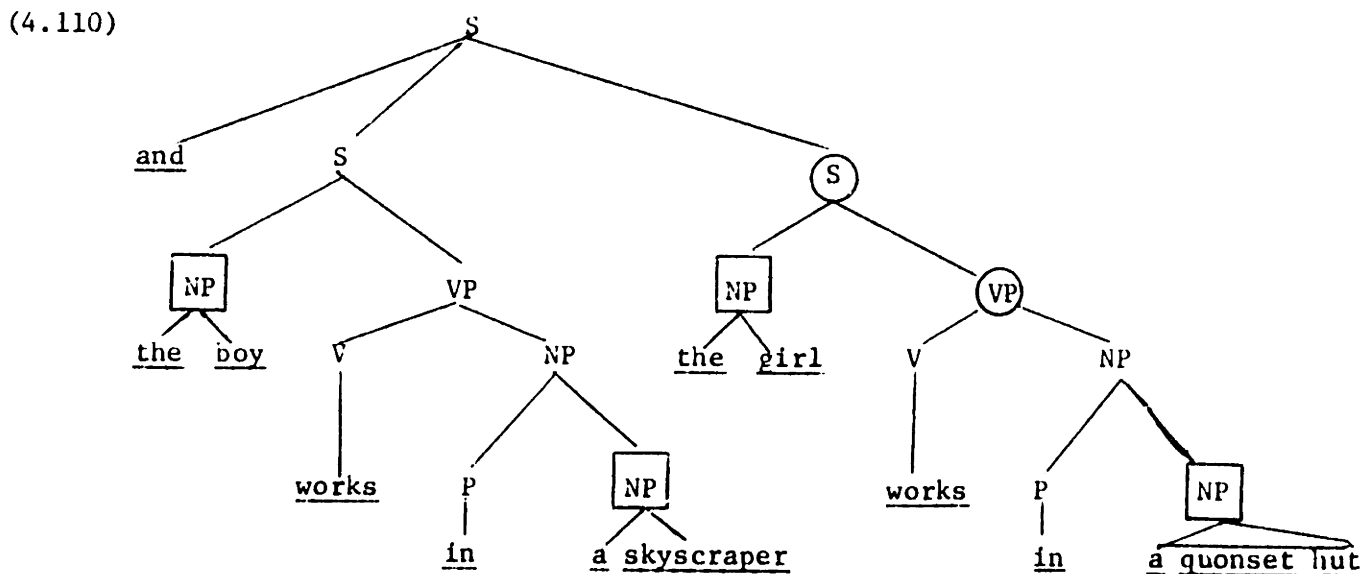

When Gapping applies to (4.110), deleting the second occurrence of the verb works, it might be proposed that either the node VP which immediately dominates it or the circled node S should be pruned, or both. There is no evidence which argues for or against retention of the circled node VP, but if the circled S were pruned, (4.110) would cease to be a coordinate structure, under the definition given in (4.85), and ^{the}boxed NPs in (4.110) should become movable. The fact that they do not (cf. (4.111))

- (4.111) a. * Which boy works in a skyscraper and the girl in a quonset hut?
- b. * The skyscraper which the boy works in and the girl in a quonset hut belongs to Uncle Sam.
- c. * The girl who the boy works in a skyscraper and in a quonset hut has a dimple on her nose.
- d. * Which quonset hut does the boy work in a skyscraper and the girl in?

is most simply accounted for by assuming that (4.110) retains its coordinate structure even after Gapping has applied, i.e., that the putative convention which pruned the circled S was incorrect.

It can also be shown that coordinate structure can disappear in the course of a derivation. So, for instance, Lakoff and Peters (op. cit.) argue that (4.112) should be derived from (4.113) by

a sequence of optional rules which convert an occurrence of and to with and then adjoin the with-phrase to the main VP of the sentence.¹³

(4.112) Billy went to the movies with a luscious
click.

(4.113)

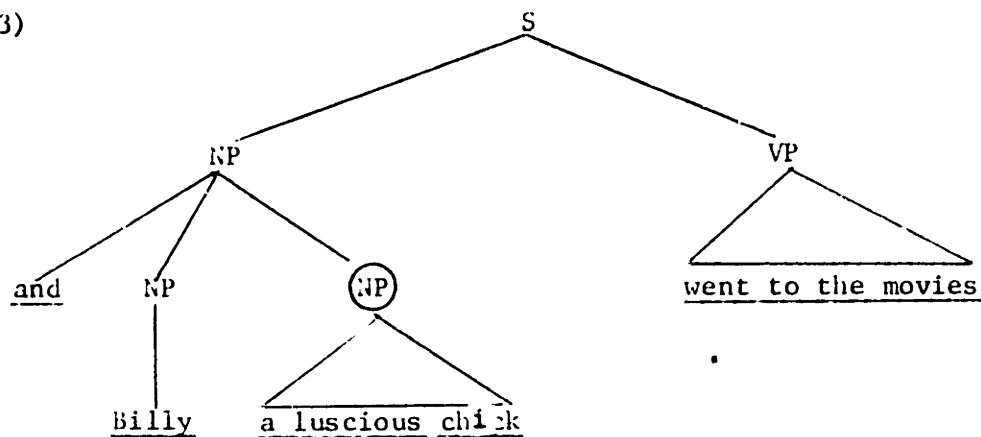

The circled NP is not relativizable unless Conjunct Movement has applied (cf. (4.114)):

- (4.114) a. The luscious click who Billy went to the
movies with will wed me ere the morn.
b. * The luscious click who Billy and went to
the movies will wed me ere the morn.

Similarly, in the conjoined structure (4.115),

(4.115)

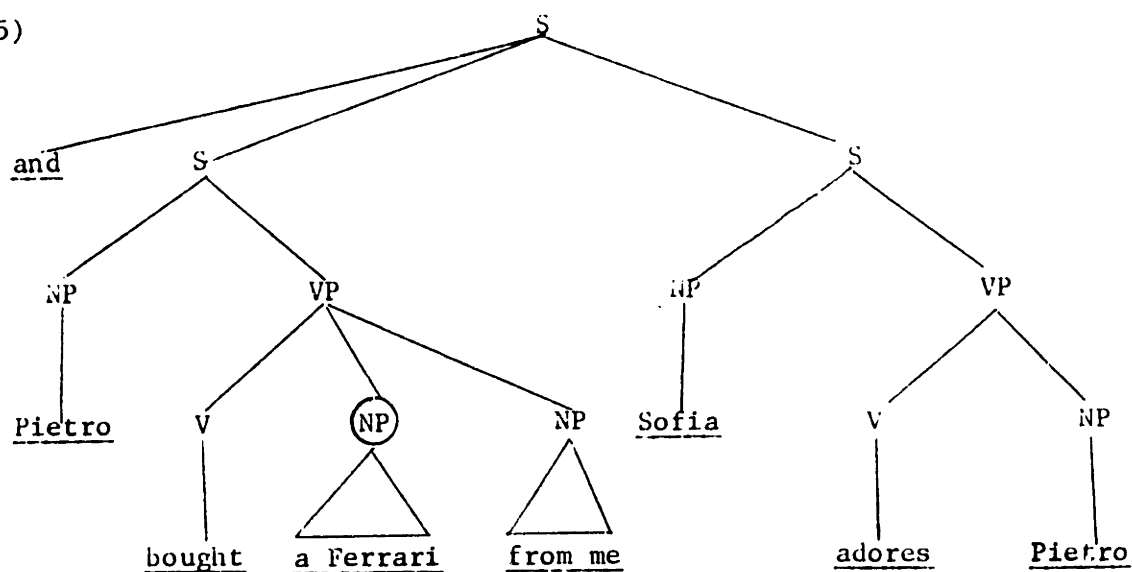

The circled NP can only be relativized if the second conjoined sentence has been inserted into the first as an appositive clause.

- (4.116) a. * The Ferrari which Pietro bought from me
and Sofia adores him cost him a bundle.¹⁴
b. The Ferrari which Pietro, who Sofia adores,
bought from me cost him a bundle.

These two facts illustrate a perhaps obvious point: whether or not a constituent can be moved depends not on deep structure, but on derived structure.

4.2.4.

4.2.4.1. There is an important class of rules to which (4.84) does not apply. These are rule schemata which move a constituent out of all

the conjuncts of a coordinate structure. In Lakoff and Ross (in preparation b), an analysis of conjoined sentences is explored which takes the process which converts such sentences as (4.117a) into (4.117b) as being the fundamental process in conjunction.

- (4.117) a. Sally might be pregnant, and everyone believes Sheila definitely is pregnant.
 b. Sally might be, and everyone believes Sheila definitely is, pregnant.

We propose a rule of Conjunction Reduction which Chomsky-adjoins to the right or left of the coordinate node a copy of some constituent which occurs in all conjuncts, on a right or left branch, respectively, and then deletes the original nodes. Thus this rule converts (4.118), which underlies (4.117), into (4.119).

(4.118)

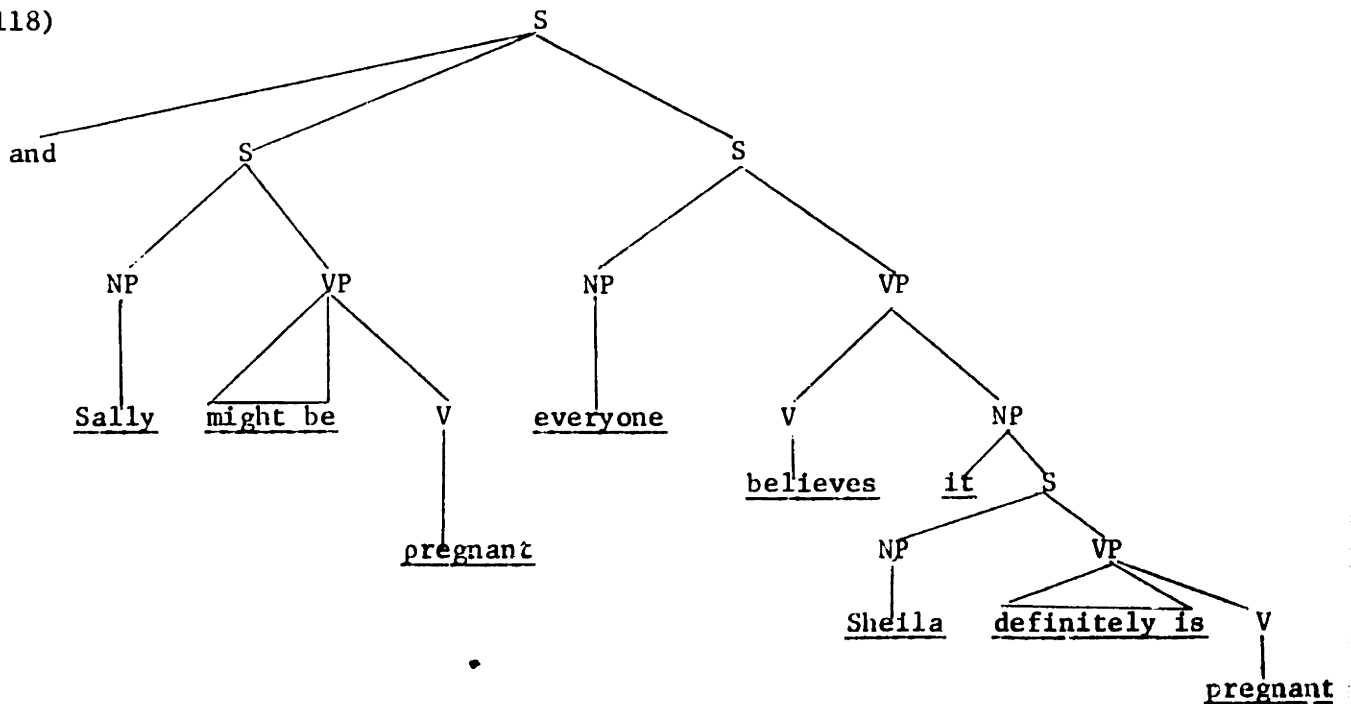

(4.119)

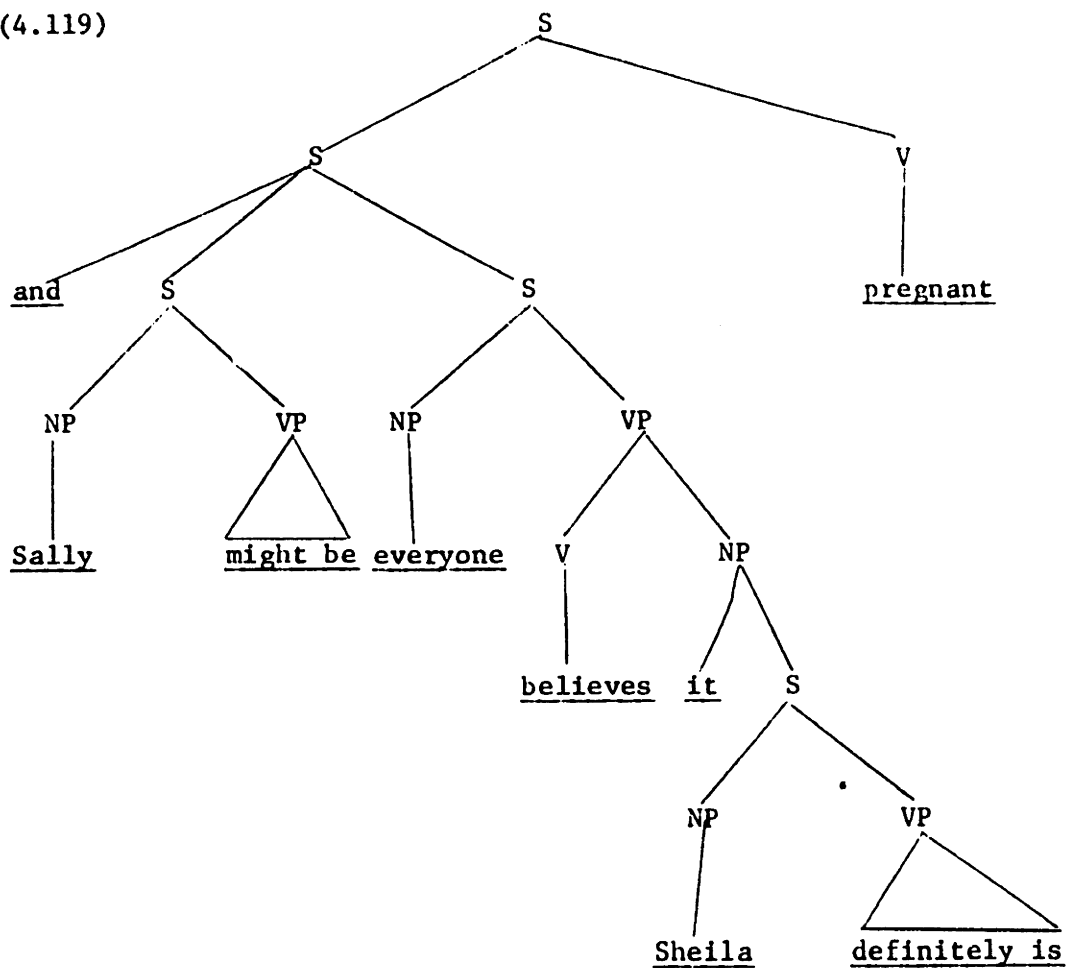

It is important to note that Conjunction Reduction must work "across the board" -- the element adjoined to the coordinate node must occur in each conjunct. Thus (4.120a) can be converted to (4.120b), but not (4.121a) to (4.121b).

- (4.120) a. Tom picked these grapes, and I washed these grapes, and Suzie will prepare these grapes.

b. Tom picked, and I washed, and Suzie will prepare, these grapes.

(4.121) a. Tom picked these grapes, and I washed some turnips, and Suzie will prepare these grapes.

b. * Tom picked, and I washed some turnips, and Suzie will prepare, these grapes.

It appears that the rule of Relative Clause Formation must also apply "across the board"; the relative clause in (4.122) would seem to have to derive from a structure with an embedded disjunction, as in (4.123),

(4.122) Students who fail the final exam or who do not do the reading will be executed.

(4.123)

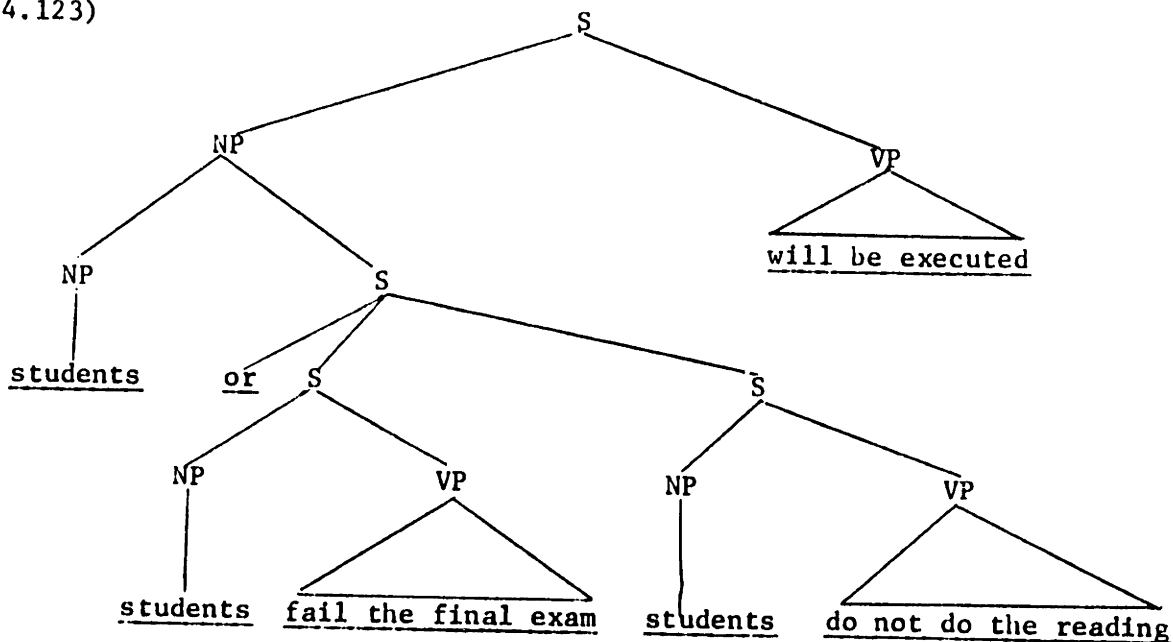

rearrange items within a conjunct.

It is evident, even from the informal description of Conjunction Reduction which was given above, that this rule moves elements out of conjuncts, but it is not evident from the statement of Relative Clause Formation which was given in (4.2) that this rule must also move elements out of conjuncts. Under the normal interpretation of the elementary operation of sister-adjunction, which is symbolized by '+' in the structural change of (4.2), when one term is sister-adjoined to a variable and that variable is null for some particular structure, nothing happens to that structure. That this convention is necessary can be seen from the following considerations:

The rule of Extrapolation sister-adjoints the sentence to a variable, as can be seen from the formal statement of this rule in (4.126).

(4.126) Extrapolation

$$\begin{array}{ccccccc}
 X & - & [\textit{it} & - & S] & - & Y \\
 & & & & \text{NP} & & \\
 1 & & 2 & & 3 & & 4 & \xrightarrow{\text{OPT}} \\
 1 & & 2 & & 0 & & 4+3
 \end{array}$$

With the above condition on sister-adjunction, if (4.126) were to apply to (4.127), no change would be effected: the sentence in apposition to it would stay within its NP.

(4.127)

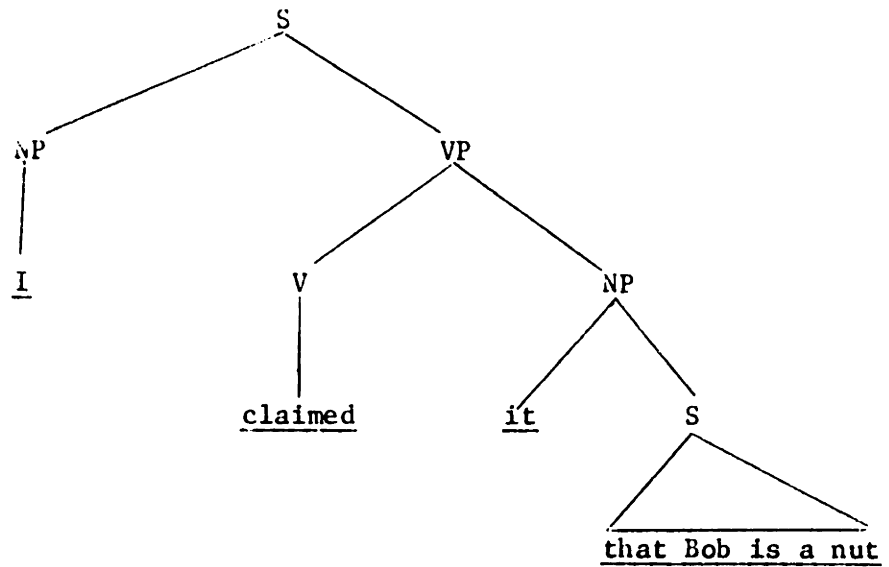

Thus the next rule in the ordering, It Deletion, could be formulated as shown in (4.128).

(4.128) It Deletion

X	-	[<u>it</u> - S]	-	Y	
		NP			
1		2	3	4	⇒ OBLIG ⇒
1		0	3	4	

However, if the convention I have suggested were not in effect, "vacuous extraposition"¹⁵ would be possible, and the embedded sentence could be moved out of its NP and attached somewhere higher up the tree, as in (4.129) (just where it would attach is not relevant for my argument, and I have drawn two dotted lines from the extraposed S in (4.129) to indicate two possibilities).

(4.129)

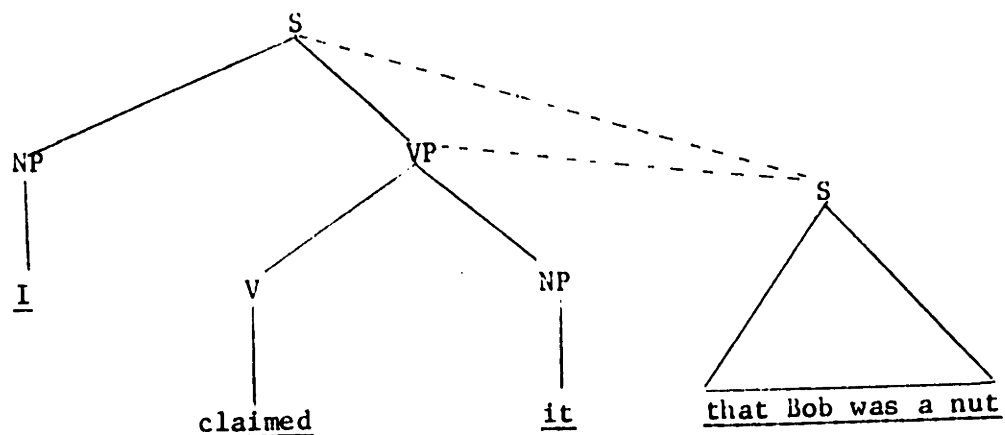

But if (4.127) can be converted into (4.129), then (4.128) will have to be modified as shown in (4.130), for otherwise this rule would not delete the it in (4.129), and the ungrammatical (4.131) would result.

(4.130) X - it - S - Y

1	2	3	4	$\xrightarrow{\text{OBLIG}}$
1	0	3	4	

(4.131) * I claimed it that Bob was a nut.

But there are many sentences which show that (4.130) is far too strong: it requires the deletion of it¹⁶ before any sentence whatsoever, and it is easy to construct sentences where this extra power leads to wrong results. In (4.132a), for instance, the it which is the object of claim will be deleted, because it precedes the clause [and I think so too]_S, and the ungrammatical (4.132b)

will result.

- (4.132) a. Although Bob may not be a nut, many people
have claimed it [and I think so too]_S.
- b. * Although Bob may not be a nut, many people
have claimed and I think so too.

To avoid converting (4.132a) into (4.132b), while still requiring the it in (4.131) to delete, some method would have to be found of indicating that the sentence that Bob was a nut is somehow "appropriate" as an environment for the deletion of the it of (4.131), but that this is not the case with respect to the sentence and I think so too in (4.132a). In the absence of independent evidence for such a convention of appropriateness, it seems more desirable to me to reject the definition of sister-adjunction which gives rise to these difficulties by allowing "vacuous" extraposition, and to impose the suggested condition on this operation -- that if a term is sister-adjoined to a null variable, no change in the d.c.s. will result.

Now let us return to the problem of the proper formulation of the rule of Relative Clause Formation. Robin Lakoff has pointed out to me that NP's in the position of the boy in (4.133) cannot be relativized (cf. (4.134)).

(4.133) The boy and the girl embraced.

(4.134) * The boy who and the girl embraced is my
neighbor.

The fact that (4.134) is ungrammatical should be accounted for by the Coordinate Structure Constraint, but since this constraint only prevents constituents from being moved, it must be the case that the formulation of the rule of Relative Clause Formation which was given in (4.2) is wrong. (4.2) specifies that the identical NP shall be sister-adjoined to a variable, and since this variable is null in the case of (4.133), by the argument given above, this NP would not be moved by (4.2), and thus the constraint would not be in effect.¹⁷ But if (4.2) is reformulated as in (4.135), the identical NP will be moved, whether it is the first constituent of the relative clause or not.

(4.135) Relative Clause Formation

$$W - \left[\begin{array}{c} \text{NP} \\ \text{NP} - [\text{S}^X - \text{NP} - \text{Y}]_{\text{S}} \end{array} \right]_{\text{NP}} - Z$$

1 2 3 4 5 6

1 2 4# [3 0 5] 6

OBLIG \Rightarrow

Condition: 2 = 4

The symbol '#' denotes the operation of Chomsky-adjunction, and the brackets in the structural change indicate that the adjoined term is not to be adjoined to term 3, but rather to the node which dominates the sequence of terms enclosed in the brackets, in this case, the node S. Thus (4.135) converts (4.136a) into (4.136b).¹⁸

(4.136) a.

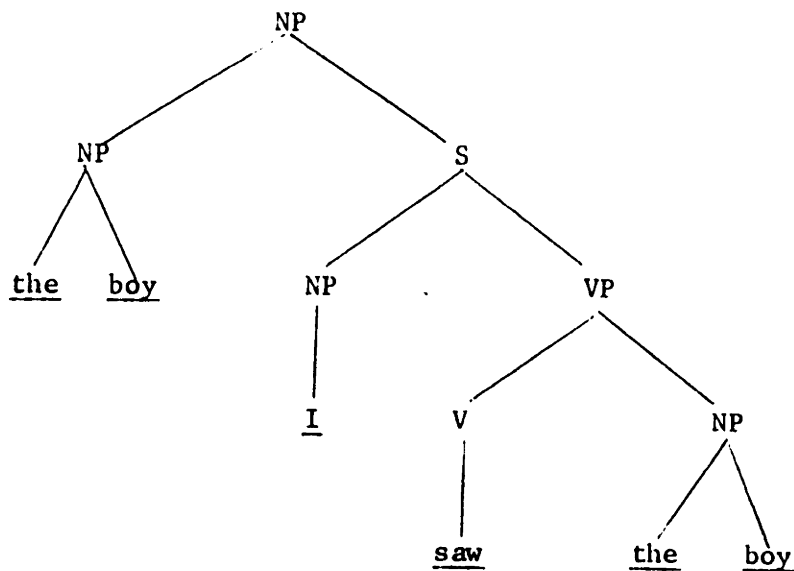

b.

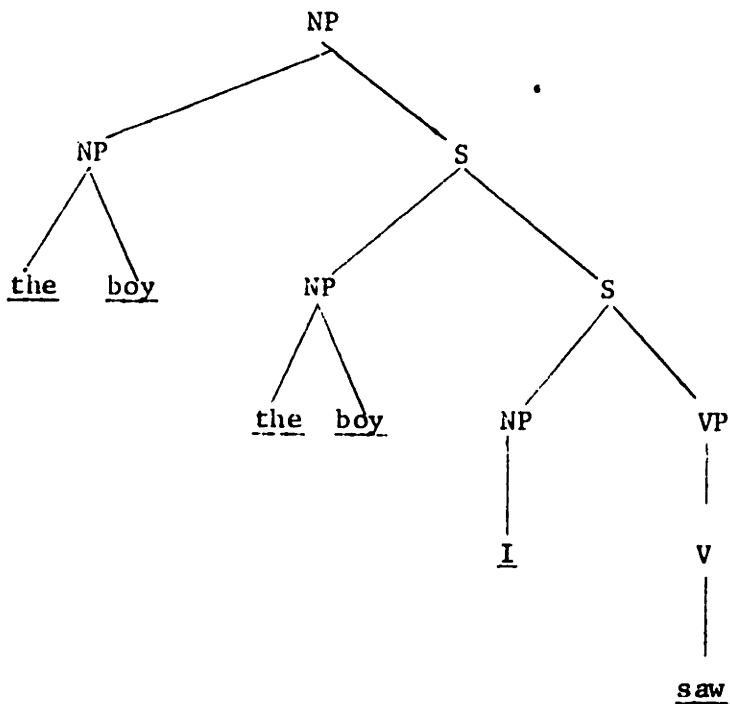

And since (4.84) would prevent the circled NP node in (4.137) from being raised and Chomsky-adjoined to the circled S by rule (4.135),

sentences like (4.134) would be blocked.

(4.137)

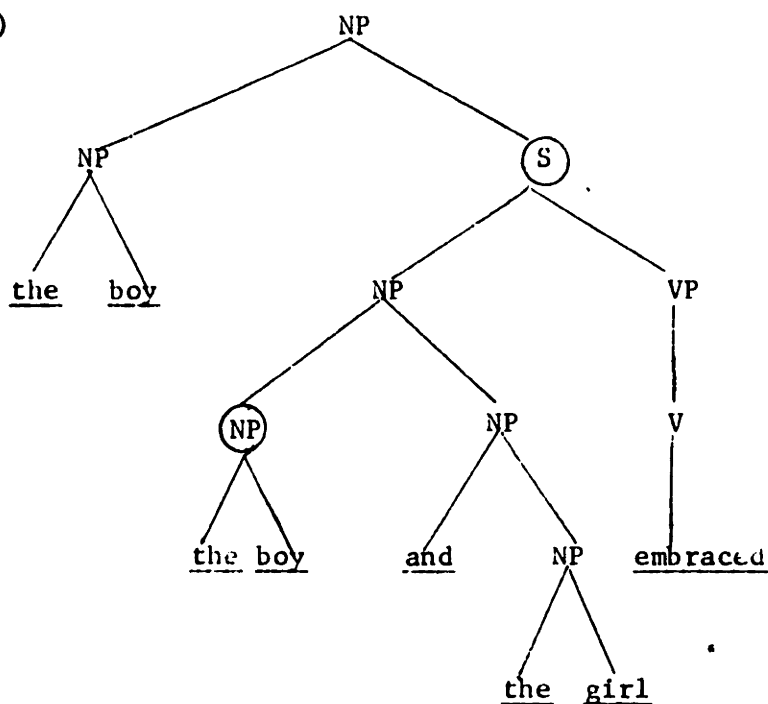

Therefore, except for the possibility that the ungrammaticality of (4.134) can be explained by rule ordering, along the lines suggested in footnote 17, it seems that it is necessary to formulate the rule of Relative Clause Formation in such a way that it becomes formally similar to the rule of Conjunction Reduction which Lakoff and I have proposed. Both rules would have the effect of moving elements contained in conjuncts out of those conjuncts, and possibly it is this formal property that the fact that they are both across-the-board rules must be attributed to.

4.2.4.3. There are other problems in grammar which are reminiscent of the across-the-board application of the two rules just discussed. These have to do with the necessity of excluding such sentences as those in (4.139), while allowing those in (4.138).

- (4.138) a. When did you get back and what did you bring me?
- b. (You) make yourself comfortable and I'll wash the dishes.
- c. Did Merv show up $\left. \begin{array}{c} \text{and} \\ \text{or} \end{array} \right\}$ did you play chess?
- (4.139) a. * Sally's sick and what did you bring me?
- b. * (You) make yourself comfortable and I got sick.
- c. * What are you eating or did you play chess?¹⁹

At first glance, it might seem possible to distinguish between (4.138a) and (4.139a) by claiming that the Question Rule must also be formulated in such a way as to Chomsky-adjoin the questioned element to the sentence which it is moved to the front of. Support for such a proposal comes from the fact that it is not any more possible to question the NP the boy in (4.133) than it was possible to relativize it.

(4.140) * Which boy and the girl embraced?

The facts of (4.134) and (4.140) are similar, and I think that it is correct to maintain that the Question Rule must be

reformulated in the same way as the rule of Relative Clause Formation was reformulated in (4.135), so that the questioned element, too, will be Chomsky-adjoined to the sentence. Also, since it seems likely that yes-no questions should be derived from whether-clauses whose initial element, after having been Chomsky-adjoined, is later deleted, sentence (4.141) could be excluded, while (4.138c) was allowed.

(4.141) * I'm hungry $\left. \begin{array}{l} \text{and} \\ \text{or} \end{array} \right\}$ did you play chess?

Promising though this approach seems, it is not capable of being strengthened to account for a wide range of additional facts. For instance, in Japanese questions, the questioned element is not moved from its original position in the structure. Thus to question the object of the verb mita 'saw' in (4.142),

(4.142) zyoozyi wa sakana o mita.
George fish saw
'George saw a fish.'

it is sufficient to replace the word sakana 'fish' with the question word nani 'what' and add the question morpheme ka to the end of the sentence, as in (4.143)

(4.143) zyoozyi wa nani o mita ka.
'What did George see?'

But the fact that (4.143) cannot be conjoined with a declarative like (4.144), as the ungrammaticality of (4.145) shows,

(4.144) neko ga nete iru.
cat sleeping is
'The cat is sleeping.'

(4.145) * zyoozyi wa nani o $\left. \begin{array}{l} \text{mita ka (to)} \\ \text{mite} \\ \text{mi} \end{array} \right\}$, neko
ga nete iru.

*'What did George see and the cat is sleeping.'

while two questions can be conjoined (cf. (4.146)),

(4.146) zyoozyi wa nani o mi neko wa nani o tabetaka?
George what see cat what ate

'What did George see and what did the cat eat?'

indicates that the attempt to exclude sentences, some of whose conjuncts are declaratives and others questions, by making the English rule of Question an across-the-board rule cannot be a successful solution to the problem in universal grammar of ensuring that only the "right kinds" of sentences get conjoined. It would seem that the non-sentences of (4.139) must therefore be excluded not by transformational constraints, but rather by deep structural ones.

In fact, there is evidence within English which supports this claim. Thus it seems that even questions like those in (4.147), which contain more than one WH-word but presumably have no history of reordering at all in their derivations, cannot be conjoined with declaratives (cf. (4.148)), although they can be conjoined with normal questions (cf. (4.149)):

- (4.147) a. Who ate what?
b. What exploded when?
c. Who gave what to whom?

- (4.148) a. Where did you go and who ate what?
 b. What exploded when and who was hurt?
 c. How long did this fit of generosity last
 and who gave what to whom?
- (4.149) a. * I saw you there and who ate what?
 b. * What exploded when and I warned you it
 would?
 c. * Who gave what to whom and I'm sickened at
 this sentiment.

As far as I can see, only some kind of deep structure constraint can be used to exclude (4.149). Moreover, the same is true with respect to (4.138b). In one sense of this sentence, it is synonymous with (4.150).

- (4.150) If you make yourself comfortable, I'll
 wash the dishes.

But there is another sense of (4.138b) which is a command, or a suggestion; and if the word please is inserted into (4.138b), the result has only this sense.

- (4.151) (You) please make yourself comfortable
 and I'll wash the dishes.

The fact that sentences like (4.139b) and (4.152) are ungrammatical

- (4.152) *(You) please make yourself comfortable and
 { the cat is dead
 I've studied Greek } .
 Jack left

- (4.154) a. Sasha is gobbling down blintzes faster than I can reheat them.
- b. I want to peruse that contract before filing it away.
- c. Fred tore the curtain in rolling it up.

Although the sentences are so complex that positive judgments are difficult to come by, I believe it to be the case that when relative clauses are formed from the sentences in (4.154), both the NP's blintzes, that contract and the curtain themselves and their anaphoric pronouns may seem to be relativized at once, as is the case in the sentences in (4.155).

- (4.155) a.?? The blintzes which Sasha is gobbling down faster than I can reheat are extremely tasty, if I do say so.
- b. ? I suspect that the contract which I wanted to peruse before filing away may have some loopholes.
- c. The curtain which Fred tore in rolling up was the kind gift of my maternal Aunt Priscilla.

I believe it is theoretically possible to relativize any number of NP's at once, although the resulting sentences are somewhat less than felicitous: the a-sentences below have been

converted into relative clauses in the corresponding b-sentences.

- (4.156) a. I want to peruse that contract before
damaging it while filing it away.
- b. ? The contract which I want to peruse
before damaging while filing away is
written on Peruvian papyrus.
- (4.157) a. ? I want to peruse that contract after
copying it by treating it in milk
while pressing it between two pieces
of marble in flattening it out.
- b. ?*The contract which I want to peruse
after copying by treating in milk while
pressing between two pieces of marble
in flattening out is a beautiful piece
of art.

Whether or not such tortured constructions as this last are to be accorded some degree of Englishness is not of great importance for this study, since I cannot even propose a rule which will generate less questionable examples, such as (4.155) and (4.156b). What makes these sentences similar to the ones discussed in § 4.2.4.2 above is the fact that not only does it seem possible to relativize some NP simultaneously from a number of clauses, but it does not seem possible to relativize an NP from only the second of these clauses. Thus if the anaphoric pronouns of (4.154) are replaced by

different NP, as in (4.158), these NP cannot be relativized, as (4.159) shows.

- (4.158) a. Sasha is gobbling down blintzes faster than I can reheat the fishballs.
- b. I want to peruse that contract before filing away the deed.
- c. Fred tore the curtain in rolling up the wallpaper.

- (4.159) a. * I think Anita may have poisoned the fishballs which Sasha is gobbling down blintzes faster than I can reheat.
- b. * The deed which I want to peruse that contract before filing away is probably a forgery.
- c. ?*The wallpaper which Fred tore the curtain in rolling up had a pleasing geometrical pattern.

The similarity stops here, however; for, bafflingly, it is possible to relativize NP in just the first of these clauses (cf. (4.160)):

- (4.160) a. The blintzes which Sasha is gobbling down faster than I can reheat the fishballs are extremely tasty, if I do say so.

- b. I suspect that the contract which I want to peruse before filing away the deed may have some loopholes.
- c. The curtain which Fred tore in rolling the wallpaper up was the kind gift of my maternal Aunt Priscilla.

Notice that it is similarly possible to relativize just the NP's blintzes, that contract and the curtain in (4.154):

- (4.161) a. The blintzes which Sasha is gobbling down faster than I can reheat them are extremely tasty, if I do say so.
- b. ? I suspect that the contract which I wanted to peruse before filing it away may have some loopholes.
- c. ? The curtain which Fred tore in rolling it up was the kind gift of my maternal Aunt Priscilla.

These facts suggest that it may be incorrect to attempt to derive the sentences in (4.155) directly from (4.154) by some kind of modified across-the-board rule. The sentences in (4.161) may be a necessary first step in this derivation, with a rule of pronoun deletion applying optionally to (4.161) to produce (4.155). This idea is given additional support by the fact that there are differences

in acceptability among the sentences of (4.155) which are exactly reversed in the sentences of (4.161). That is, while (4.155a) is far more awkward for me than (4.155b), which in turn is slightly more awkward than the fully grammatical (4.155c), in (4.161), it is the a-version which is fully grammatical, the b-version which is slightly doubtful, and the c-version which is the most dubious of all. These differences can be accounted for if it is assumed that the rule of pronoun deletion which transforms (4.161) into (4.155) is obligatory in the case of (4.161c), optional in the case of (4.161b), and not applicable in the case of (4.161a). This attempt at explanation does not yet have much force, for I have no idea what features of the environment the optionality of this rule depends upon, nor how to state the rule, but perhaps it is at least a correct line of attack on this problem.

4.2.5. In summary, I have tried to show in the above sections that Case F of §2.2 can be excluded by a constraint of great generality, the Coordinate Structure Constraint, which is needed independently of the other constraints of this chapter. It is more powerful than the A-over-A principle, which cannot exclude sentences like (4.82). It can be used as a criterion for coordinate structure, and on this basis, it was argued in § 4.2.3 that nodes which are coordinate in deep structure may cease to be so in the course

of a derivation and that nodes which appear to be coordinate in surface structure may not be. The statement of the constraint in (4.84) was shown to require modification to account for the facts of the class of across-the-board rules, which must operate in all conjuncts simultaneously. A tentative hypothesis about the formal properties of such across-the-board rules was advanced. At present, I know of no rules which are not subject to the Coordinate Structure Constraint, except for the rule of Appositive Clause Formation, which I will discuss in § 6.2.4 below, so I propose that this constraint be added to the theory of grammar.

4.3. The Pied Piping Convention

4.3.1. In this section, I will suggest a constraint which can successfully account for the evidence for the A-over-A principle which was presented in case D and case E of § 2.2, and a convention which will provide for the generation of all the relative clauses in the sentences of (4.163). These must all be derived from (4.162), the approximate structure of sentence (2.3), which I have repeated here, for convenience.

(2.3) The government prescribes the height of
 the lettering on the covers of the reports.

(4.162)

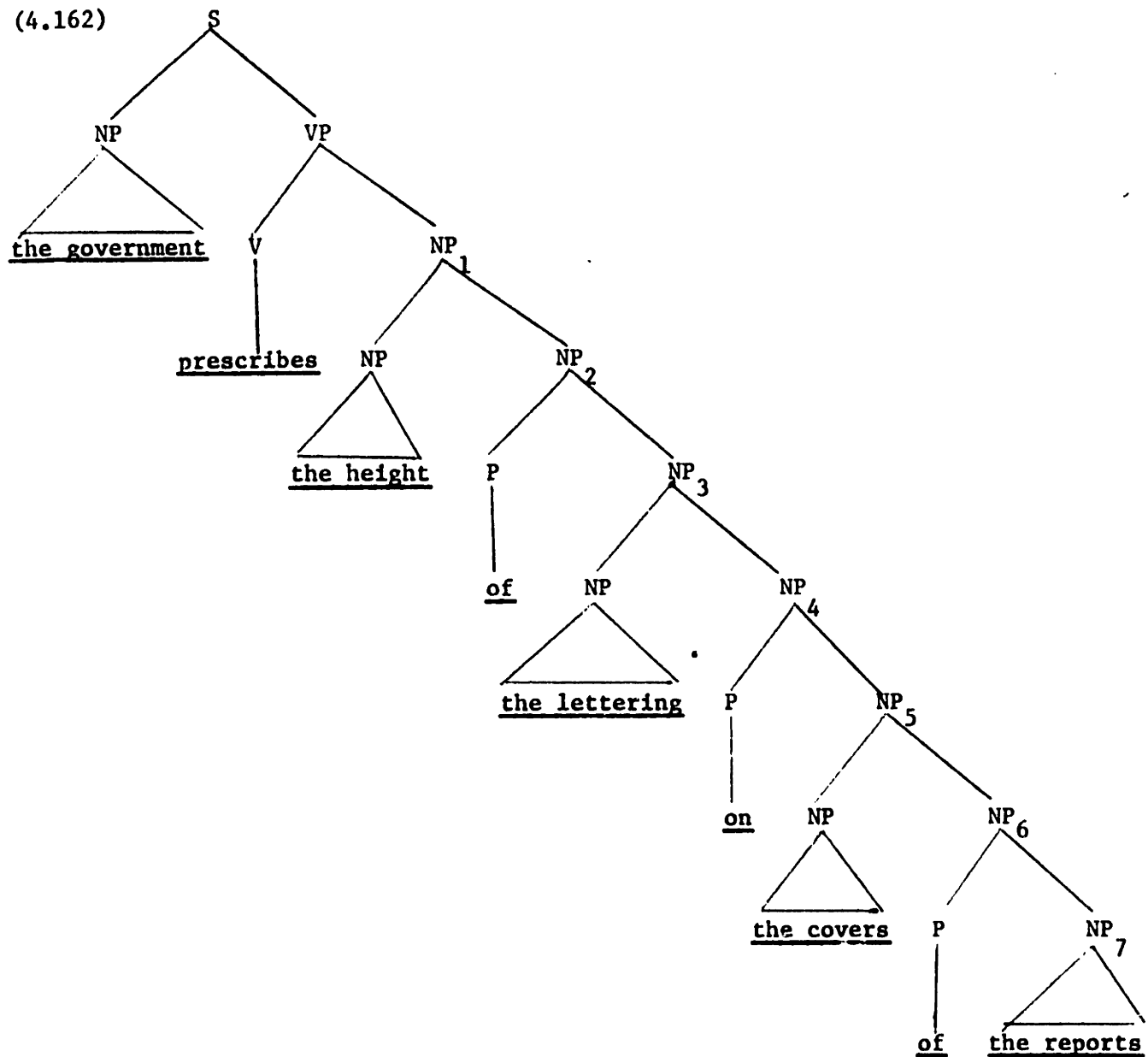

- (4.163) a. Reports which the government prescribes the height of the lettering on the covers of are invariably boring.

- b. Reports the covers of which the government prescribes the height of the lettering on almost always put me to sleep.
- c. Reports the lettering on the covers of which the government prescribes the height of are a shocking waste of public funds.
- d. Reports the height of the lettering on the covers of which the government prescribes should be abolished.

It can be seen that if the structure in (4.162) were embedded as a relative clause modifier in a noun phrase whose head noun is report, the rule of Relative Clause Formation, as it is stated in (4.135), would only produce the relative clause in (4.163a). If an attempt were made to modify the structural index of (4.135) in such a way that the new rule would derive either (4.163a) or (4.163b) from (4.162), the revised rule would be that shown in (4.164):

$$(4.164) \quad W - \left[\begin{array}{c} \text{NP} \\ \text{NP} \end{array} - \left[\begin{array}{c} X \\ S \end{array} - \left\{ \begin{array}{c} \emptyset - \text{NP} \\ \left[\begin{array}{c} \text{NP} \text{ NP } P - \text{NP} \end{array} \right]_{\text{NP}} \end{array} \right\} - Y \right]_S \right]_{\text{NP}} - Z$$

1	2	3	4	5	6	7	OBLIG
1	2[45]#[3	0	0	6]	7		→

Condition: 2 = 5

To derive the relative clause in (4.163c), the further complication of the rule shown in (4.165) would be necessary,

$$(4.165) \quad W - \left[\begin{array}{c} \text{NP} \\ \text{NP} \end{array} - [S X - \left\{ \begin{array}{c} \emptyset - \text{NP} \\ [\text{NP} \text{NP} \text{P} - \text{NP}] \\ [\text{NP} \text{NP} \text{P} [\text{NP} \text{NP} \text{P} - \text{NP}]] \end{array} \right\} - Y]_S \right]_{\text{NP}} - Z$$

	1	2	3	4	5	6	7	OBLIG
	1	2[4 5]#[3	0	0	6]	7	7	=====

Condition: 2 = 5

and deriving the clause in (4.163d) would entail adding a fourth line to the disjunction inside the braces in (4.165).⁴ But since there is no upper bound on the length of a branch consisting entirely of NP's, like NP₁ - NP₇ in (4.162), in order to give a finite formulation of this rule, which must be able to generate clauses like those of (4.163) to any desired degree of complexity, either some abbreviatory notation, under which the sequences of terms within the parentheses of (4.164), (4.165), etc. can be collapsed, must be added to the theory of grammar, or some special convention must be. Of these two, the latter is weaker, for to add a new abbreviatory notation to the theory is to make the claim that there are other cases, unrelated to the case at hand, where rules must be collapsed according to the new notation. No such cases exist, to my knowledge, so I propose the

convention given in (4.166) as a first approximation to an appropriate universal convention.

- (4.166) Any transformation which is stated in such a way as to effect the reordering of some specified node NP, where this node is preceded and followed by variables, can reorder this NP or any NP which dominates it.²⁰

By the term "specified" in (4.166), I mean that node NP, in a branch containing many NP nodes, which is singled out from all other nodes on this branch by virtue of some added condition on the rule in question, such as the condition on the rule of Relative Clause Formation that the NP to be relativized be identical to the NP which the clause modifies, or the condition on the rule of Question that the questioned NP dominate WH+some. This convention, then, provides that any reordering transformation which is stated as operating on some NP singled out in some such way may instead operate on any higher NP. Thus the formulation of Relative Clause Formation which was given in (4.135), when supplemented by (4.166), will allow for the adjoining to the front of the sentence of the specified NP₇, the reports, or NP₆, of the reports, or NP₅, the covers of the reports, etc., so that all of the clauses in (4.163) will be generated. That (4.166) is too strong, in that it does not exclude the ungrammatical sentences of (4.167) need not concern us here;

- (4.167) a. * Reports of which the government prescribes
the height of the lettering on the covers
are invariably boring.
- b. * Reports on the covers of which the
government prescribes the height of the
lettering almost always put me to sleep.
- c. * Reports of the lettering on the covers
of which the government prescribes the
height are shocking waste of public funds.

there seems to be a constraint, in my dialect at least, which prohibits noun phrases which start with prepositions from being relativized and questioned when these directly follow the NP they modify. Thus (4.168) can be questioned to form (4.169a), but not (4.169b).

(4.168) He has books by several Greek authors.

(4.169) a. Which Greek authors does he have books by?

b. ?*By which Greek authors does he have books?

I will not attempt a more precise formulation of this restriction here: instead, I will point out two further inadequacies in the formulation of (4.166).

Firstly, if the structure shown in (4.170) were to be embedded as a relative clause on an NP whose head noun were the boy,

(4.170)

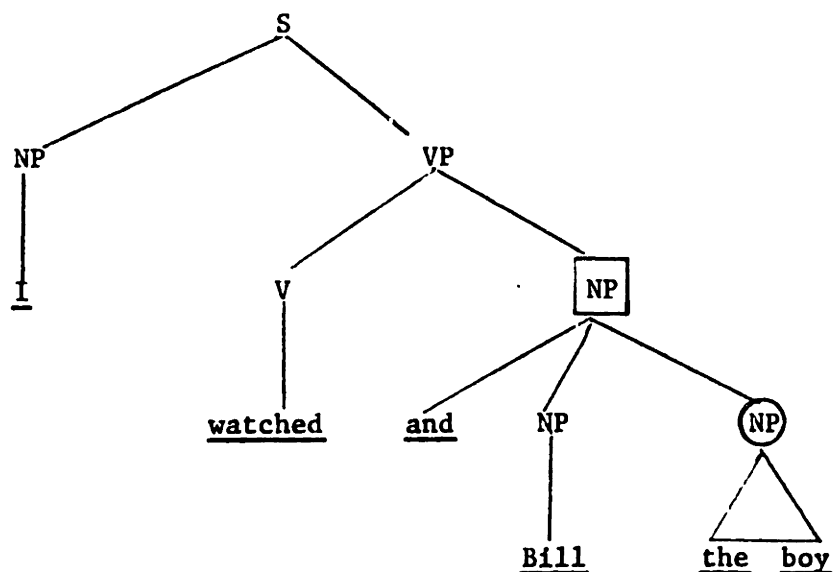

the Coordinate Structure Constraint would not allow the formation of (4.171):

(4.171) * The boy who I watched Bill and was vain.

However, the circled node NP is dominated by the boxed node NP, and convention (4.166) would allow this higher node to be preposed, which would result in the ungrammatical (4.172).

(4.172) * The boy Bill and who(m) I watched was vain.

The ungrammaticality of this sentence indicates the necessity of revising (4.166) in such a way that if an NP dominating the specified NP is coordinate, neither it nor any higher NP can be moved. I will incorporate such a revision into the final version of the convention, which will be stated in (4.180).

The second inadequacy of (4.166) can be seen in connection with P-marker (4.173).

(4.173)

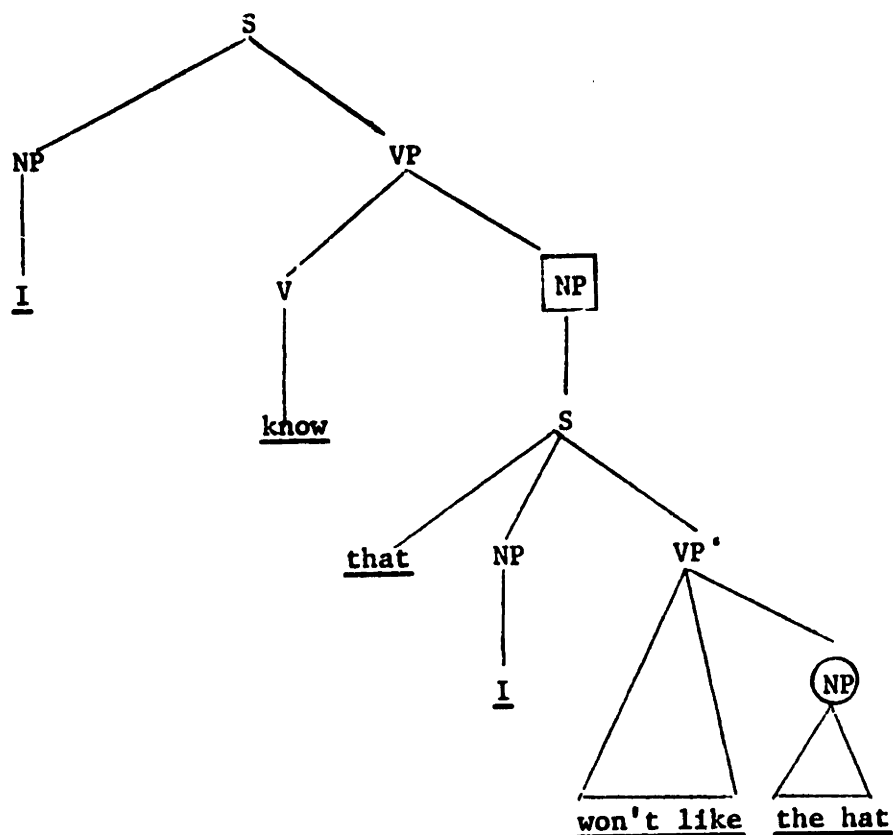

while it is true that the circled node NP can be relativized, as (4.174) shows,

(4.174) They will give me a hat which I know
that I won't like.

once again, (4.166) would allow the preposing of the boxed node NP, and the ungrammatical (4.175) would be produced.

- (4.175) * They will give me a hat that I won't
like which I know.

The modification of (4.166) that seems to be required here is that if a branch of a P-marker has an occurrence of the node S intervening between two occurrences of the node NP, only the lower one can be reordered. This restriction does not extend to the node VP, however, as can be seen from the following example.

The approximate structure of the German sentence in (4.176) is that shown in (4.177).

- (4.176) Ich habe den Hund zu finden zu versuchen angefangen.
I have the dog to find to try begun
'I have begun to try to find the dog.'

(4.177)

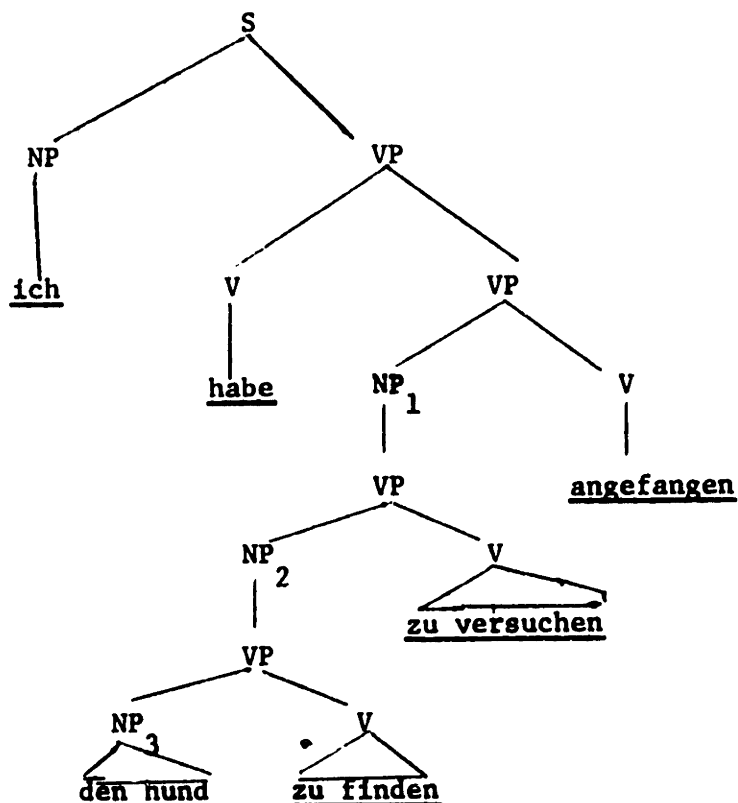

If the structure which underlies (4.177) has been embedded as a relative clause on the subject NP of the structure underlying (4.178),

(4.178) Der Hund ist ein Bernardiner.

'The dog is a St. Bernard.'

the rule of Relative Clause Formation must produce all three of the clauses in the sentences of (4.179).

(4.179) a. Der Hund, den ich zu finden zu versuchen
angefangen habe, ist ein Bernardiner.²¹

b. Der Hund, den zu finden ich zu versuchen
angefangen habe, ist ein Bernardiner.

c. Der Hund, den zu finden zu versuchen ich
angefangen habe, ist ein Bernardiner.

'The dog which I have begun to try to
find is a St. Bernard.'

In (4.179a), only the specified node, NP_3 in (4.177), has been preposed, while in (4.179b), the phrase dominated by NP_2 , which contains NP_3 , has been preposed, and in (4.179c), the largest NP, NP_1 , had been preposed. Note that these three NP nodes are separated by two VP nodes in (4.177), but that (4.166) still is operative. This then indicates that it is only the node S, as was claimed above, to which reference must be made in revising (4.166).²²

In (4.180), I have modified the convention given in (4.166) in such a way as to overcome the two inadequacies I have just

discussed.

(4.180) The Pied Piping Convention²³

Any transformation which is stated in such a way as to effect the reordering of some specified node NP, where this node is preceded and followed by variables in the structural index of the rule, may apply to this NP or to any non-coordinate NP which dominates it, as long as there are no occurrences of any coordinate node, nor of the node S, on the branch connecting the higher node and the specified node.

4.3.2.

4.3.2.0. The convention stated in (4.180) stipulates that any NP above some specified one may be reordered, instead of the specified one, but there are environments where the lower NP may not be moved, and only some higher one can, consonant with the conditions imposed in (4.180). In other words, pied piping is obligatory in some contexts.²⁴ In § 4.3.2.1, I will describe two environments in which pied piping is obligatory, whether the specified NP is to be moved to the right or to the left, and in § 4.3.2.2, I will cite several environments in which pied piping cannot apply. In § 4.3.2.3, I will discuss the one environment I know of in which pied piping is obligatory if an NP

is moved in one direction, but not if it is moved in the other. In § 4.3.2.4, I will show how the constraints on pied piping developed in these sections interact with the rule of Conjunction Reduction, and in § 4.3.2.5, I will explore the question of the theoretical status of the various conditions on (4.180) which are discussed in §§ 4.3.2.1 - 4.3.2.4.

4.3.2.1. For English, and for many other languages, the following constraint, which has the effect of making pied piping obligatory in the stated environment, obtains:

(4.181) The Left Branch Condition

No NP which is the leftmost constituent of a larger NP can be reordered out of this NP by a transformational rule.

In other words, (4.181) prohibits the NP shown in (4.182) from moving along the paths of either of the arrows.

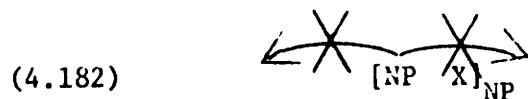

This constraint accounts for the following facts: if the structure shown in (4.183) is embedded as a relative clause modifier of a NP whose head noun is boy, only one output is possible --

(4.184a)

(4.183)

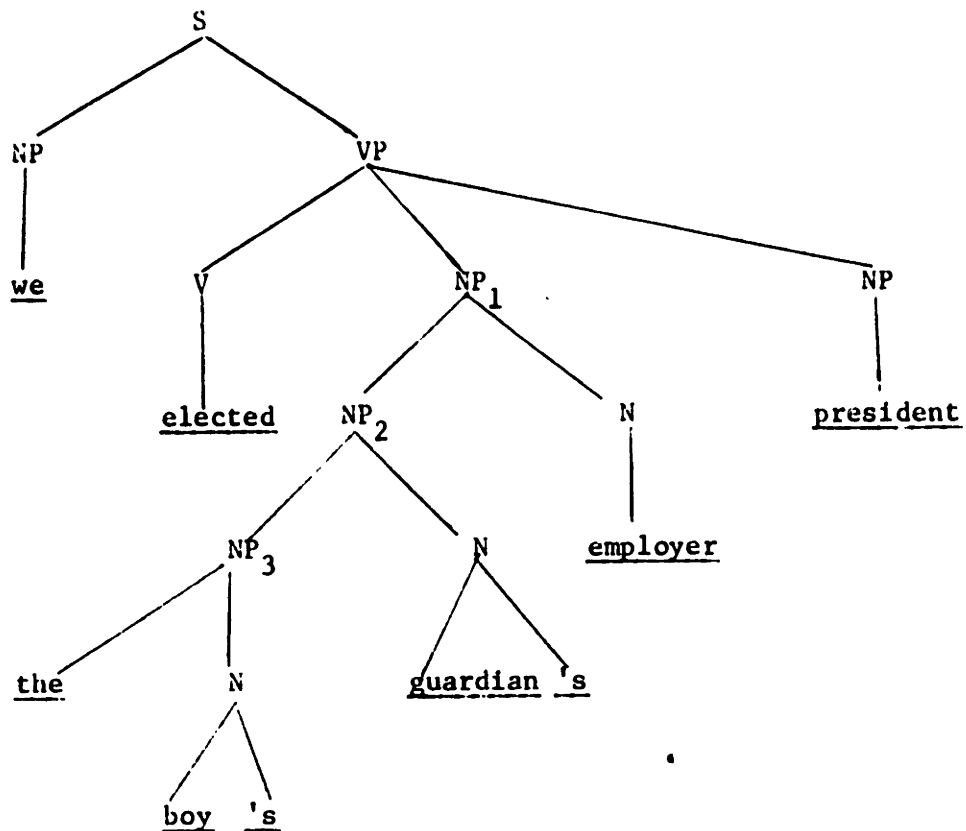

- (4.184) a. The boy whose guardian's employer we elected president ratted on us.
 b. * The boy whose guardian's we elected employer president ratted on us.
 c. * The boy whose we elected guardian's employer president ratted on us.

Sentence (4.184c) is excluded by (4.181), because the rule of Relative Clause Formation has moved the lowest NP, NP₃, from the left branch of NP₁. In (4.184b), it is NP₂ that has been moved from this branch. Since the Left Branch Condition

prohibits both of these operations, only the largest NP which (4.180) allows to be moved, NP₁, can be moved to the front of the sentence, and when this happens, (4.184a) is the result.

Parallel facts can be adduced for non-restrictive relative clauses, which differ from restrictives in being preceded and followed by heavy intonation breaks. They derive from coordinate sentences in deep structure, and they are formed by a different rule than (4.135). If commas are inserted into the sentences of (4.184), after boy and investigated, thus forcing a non-restrictive interpretation of the clauses, their grammaticality is unchanged.

Another rule which is affected by this condition is the rule of Topicalization, (4.185), which converts (4.186a) to (4.186b).

(4.185) Topicalization

X	-	NP	-	Y	
1		2		3	OPT →
2#[1		0		3]	

- (4.186) a. I'm going to ask Bill to make the old geezer take up these points later.
- b. These points I'm going to ask Bill to make the old geezer take up later.

If rule (4.185) is applied to (4.183), once again it will be seen that only NP₁ can be topicalized, as in (4.187a). If either NP₂ or NP₃ is topicalized, as in (4.187b) and (4.187c), respectively,

ungrammatical sentences result.

- (4.187) a. The boy's guardian's employer we elected president.
- b. * The boy's guardian's we elected employer president.
- c. * The boy's we elected guardian's employer president.

A rule that was stated in (3.26), Complex NP Shift, which performs almost the same operation as (4.185), except that it moves the NP in the opposite direction, is also subject to the Left Branch Condition. This rule may apply to (4.183) to move NP₁ over president (cf. (4.188a)),²⁵ but neither NP₂ nor NP₃ can be so moved, as the ungrammaticality of (4.188b) and (4.188c) demonstrates.

- (4.188) a. We elected president the boy's guardian's employer.
- b. * We elected employer president the boy's guardian's.
- c. * We elected guardian's employer president the boy.

Finally, the Question Rule is subject to the condition: if NP₃ in (4.183) is questioned, it cannot be moved to the front of the sentence alone -- pied piping must apply to carry NP₁ with it, as (4.189) shows.

- (4.189) a. Which boy's guardian's employer did we
elect president?
- b. * Which boy's guardian's did we elect
employer president?
- c. * Which boy's did we elect guardian's
employer president?

One of the facts which supports the analysis of predicate adjectives which is implicit in diagram (3.25) above is the fact that when adverbs of degree which occur in pre-adjectival or pre-adverbial position are questioned, the questioned constituent, how, cannot be moved to the front of the sentence alone, as in (4.190a) and (4.191a), but only if the adjective or adverb is moved with it, as in (4.190b) and (4.191b).

- (4.190) a. * How is Peter sane?²⁶
- b. How sane is Peter?
- (4.191) a. * How have you picked up TNT carelessly?
- b. How carelessly have you picked up TNT?

These facts can be explained by (4.181), if how is analyzed as deriving from an underlying NP, and the adjective sane and the adverb carelessly are dominated by NP at the stage of derivations at which questions are formed. Note also that if the degree adverb that in (4.192) is questioned, pied piping must apply to move not only tall, but also a man to the front of the sentence.

(4.192) Sheila married that tall a man.

(4.193) a. How tall a man did Sheila marry?

b. * How tall did Sheila marry a man?

c. * How did Sheila marry tall a man?

These facts are accounted for if the structure of (4.193a) at the point when the Question Rule applies is that shown in (4.194),

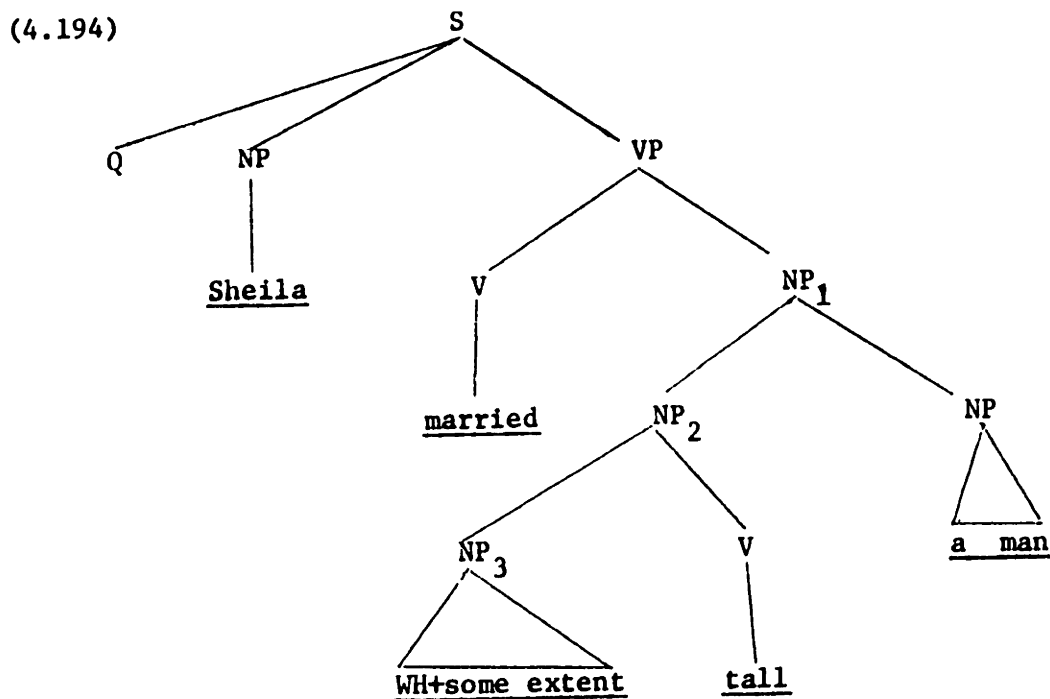

for (4.181) will not permit either NP_3 or NP_2 to be moved out of NP_1 .

One other set of facts deserves mention in connection with this analysis of adjectives. In German, it is possible to topicalize

adverbs -- thus the manner adverb genüsslich 'with pleasure' in (4.195a) can occur at the front of the sentence, as in (4.195b).

- (4.195) a. Wir haben die Bohnen genüsslich verschlungen.
 we have the beans with pleasure gobbled up.
 'We gobbled up the beans with pleasure.'
- b. Genüsslich haben wir die Bohnen verschlungen.

If an analysis in which adverbs are treated as being derived from NP can be maintained, not only will it be unnecessary to complicate rule (4.185) to derive (4.195b) from the structure which underlies (4.195a), but it will be possible to explain the following facts in addition. In German, the adverb fast 'almost' normally precedes the adjective it modifies, but it can follow it (cf. (4.196)). The adverb sehr 'very', however, only occurs pre-adjectivally (cf. (4.197)).

- (4.196) a. Walburga ist fast hübsch.
 'Walburga is almost pretty.'
- b. Walburga ist hübsch, fast.
- (4.197) a. Liselotte ist sehr hübsch.
 'Liselotte is very pretty.'
- b. *Liselotte ist hübsch, sehr.

These facts suggest that whatever rule it is that moves fast around hübsch in (4.196) be made obligatory for degree adverbs like sehr. If this reordering rule adjoins the adverbs which are moved around the adjectives to the adjectives, and if this reordering rule precedes the rule of Topicalization, the fact that fast can be

topicalized with or without hübsch (cf. (4.198)), but ^{that} sehr cannot be topicalized by itself (cf. (4.199)) is accounted for by the Left Branch Condition.

- (4.198) a. Fast hübsch ist Walburga.
 b. Fast ₁ ist Walburga hübsch.
- (4.199) a. Sehr hübsch ist Liselotte.
 b. * Sehr ist Liselotte hübsch.

Of course, it is possible to account for these facts concerning adjectives and adverbs in other ways than by assuming that both types of constituents are dominated by NP up to some point in derivations, but the analysis sketched here has the virtue of allowing a simpler statement of the rules of Topicalization and Question and of constraints like (4.181) than can otherwise be achieved, as far as I can see. However, since I have not made a detailed study of adverbs, it may be the case that this analysis will have to be excluded because it engenders complications in other parts of the grammar.

In passing, it should be noted that Case D and Case E of § 2.2, which provide evidence for the A-over-A principle, are special cases of the Left Branch Condition, which will block the derivation of the ungrammatical (2.11) and (2.15).

Another environment in which pied piping is obligatory in German, French, Italian, Russian, Finnish, and in many other languages, is that stated in (4.200).

- (4.200) No NP may be moved out of the environment
[P ___]_{NP}.

In these languages, only sentences like (4.201) are possible -- sentences corresponding to those in (4.202), where a NP has been moved away from its preposition, are ungrammatical.

- (4.201) a. On which bed does Tom sleep?
b. The bed on which Tom slept was hard.

- (4.202) a. Which bed did Tom sleep on?
b. The bed which Tom slept on was hard.

Kuroda has pointed out similar facts for English with respect to a certain class of nouns (cf. Kuroda (1964)). Kuroda pointed out that it is just with the class of nouns that cannot be pronominalized, i.e., nouns like time, way, manner, place, etc., that sentences like (4.202) are impossible. That is, the sentences in (4.203) cannot be converted into the corresponding ones in (4.204) by normal rules of pronominalization.

- (4.203) a. My sister arrived at a time when no busses were running, and my brother arrived at a time when no busses were running too.
b. Jack disappeared in a mysterious manner and Marian disappeared in a mysterious manner too.
c. I live at the place where Route 150 crosses Scrak River and my dad lives at the place where Route 150 crosses Scrak River too.

- (4.204) a. * My sister arrived at a time when no
busses were running and my brother
arrived at one too.
- b. * Jack disappeared in a mysterious manner
and Marion disappeared in one too.
- c. * I live at the place where Route 150 crosses
Scrak River and my dad lives at it too.

Furthermore, prepositions cannot be left behind in such constructions either (cf. (4.205)).

- (4.205) a. * What time did you arrive at?
- b. * The manner which Jack disappeared in was
creepy.
- c. * The place which I live at is the place
where Route 150 crosses Scrak River.²⁷

The facts indicate that though the constraint in (4.200) does not obtain for English, the modified version shown in (4.206) does:

- (4.206) No NP whose head noun is not pronominalizable
may be moved out of the environment [P ___]_{NP}.

The three constraints discussed in this section - (4.181), (4.200), and (4.206) - are all cases where the optionality which is built into (4.180) is abrogated in favor of higher NP nodes. That is, if NP_i dominates NP_j , (4.180) in general allows either NP to

reorder, but the above three constraints limit this freedom: they state environments in which only the higher NP can reorder. In the next section, I will discuss two constraints which have the opposite effect.

4.3.2.2. After most verb-particle combinations whose object is a prepositional phrase, such as do away with, make up to, sit in on, get away with, etc., while the NP in the prepositional phrase is movable, the preposition may not be moved with it. Thus though the sentences in (4.207) are possible, corresponding ones in (4.208) are not.

- (4.207) a. The only relatives who' I'd like to do
away with are my aunts.
- b. Who is she trying to make up to now?
- c. That meeting I'd like to sit in on.
- (4.208) a. * The only relatives with whom I'd like to
do away are my aunts.
- b. * To whom is she trying to make up now?
- c. * On that meeting I'd like to sit in.

For some reason which I do not understand, there are other verbs which seem to be of exactly the same syntactic type for which such constructions as (4.208) are permissible. Thus the sentences in (4.209) are markedly better, for me, than those in (4.208).

- (4.209) a. ? The abuse with which she puts up is phenomenal.
 b. For whose rights do you expect me to speak up?
 c. For these principles I have never hesitated
 to speak out.

Similar facts obtain for such syntactic idioms as get wind of, make light of, get hold of, etc. Normally, in my speech at least, the preposition must be left behind for most of these idioms -- compare (4.210) and (4.211).

- (4.210) a. One plan which I got wind of was calculated
 to keep us in suspense.
 b. Did you notice which difficulties she made
 light of?
 c. Who are you trying to get hold of?

- (4.211) a. * One plan of which I got wind was calculated
 to keep us in suspense.
 b. ?*Did you notice of which difficulties she
 made light?
 c. * Of whom are you trying to get hold?

However, there are certain of these syntactic idioms for which the preposition seems to be movable, just as was the case with the verb-particle combinations shown in (4.209).

- (4.212) a. The only offer of which I plan to take advantage will give me an eleven-month paid vacation.
- b. ? In the countries of which I've been keeping track, the existing political systems are fantastically corrupt.
- c. The scenes to which the censors took objection had to do with the mixed marriage of a woman and a giant panda.

I believe that sentences like those in (4.209) and (4.212) are the exception, rather than the rule, so presumably some constraint like (4.213) must be stated for English.

- (4.213) No NP with the analysis [P NP]_{NP} may be moved if it follows an idiomatic V - A sequence, where A is some single constituent.

The constituent A may be a particle (cf. (4.207) and (4.208)), an adjective (as in make light of, make sure of, etc.), a verb (as in make do with, let fly at, let go of, get hold of, get rid of (if rid should be analyzed as a verb here)), lay claim to, hold sway over, pay heed to, etc.), a noun (as in get wind of, set fire to, lay siege to, make use of, lose track of, take charge of, take umbrage at, etc.), or possibly a noun phrase (e.g., get the drop on, make no bones about, set one's sights on).

There is a possibility, as Paul Kiparsky has pointed out to me, that the difference between (4.211) and (4.212) may correlate with whether the idiom in question has a single or a double passive. That is, in many cases, verbs like those in (4.212), where the preposition may be moved, allow either the first element after the verb or the object of the preposition to become the subject of the passive.

(4.214) a. Advantage will be taken of his offer.

b. His offer will be taken advantage of.

(4.215) a. ? In this experiment, track must be kept of fourteen variables simultaneously.

b. In this experiment, fourteen variables must be kept track of simultaneously.

(4.216) a. Objection was taken to the length of our skirts.

b. ? The length of our skirts was taken objection to.

The sentences of (4.214) - (4.216) attest to the fact that the syntactic idioms of (4.212), whose prepositions are not subject to (4.213), have double passives. But the idioms in (4.210), whose prepositions are shown to be subject to (4.213) by the ungrammaticality of (4.211), have only one passive, as can be seen from the ungrammaticality of the a-versions of sentences (4.217)-(4.219).

- (4.217) a. * Wind was gotten of a plot to negotiate
an honorable end to the war in Vietnam.
- b. A plan to negotiate an honorable end to
the war in Vietnam was gotten wind of.
- (4.218) a. * Light was made of her indiscretions.
- b. Her indiscretions were made light of.
- (4.219) a. * Hold has been gotten of some rare old
manuscripts.
- b. Some rare old manuscripts have been
gotten hold of.

The correspondence between the class of syntactic idioms which allow passives like those in (4.214a), (4.215a), and (4.216a), and the class of idioms whose prepositions are not subject to (4.213) is too close to be merely coincidental, but for me, at least, it is not exact. If it were, the differences in acceptability between the a and b-sentences below would not exist.

- (4.220) a. Use was made of Sikolsky's pigeon-holing
lemma.
- b. ? The lemma of which I will make use is due
to Sikolsky.
- (4.221) a. Tabs were kept on all persons entering
the station.
- b. ??The persons on whom we kept tabs all
proved to be innocent.

- (4.222) a. * Faith was had in all kinds of people.
 b. ? The only representative in whom I have
 faith is still in the Bahamas.

But I have not made a close study of all cases which run counter to Kiparsky's suggestion, to see if they can be explained away. I believe that it will eventually become possible to incorporate this suggestion into a revised version of (4.213), even though I am unable to do so now. But it is clear that some other explanation must be devised for the sentences of (4.209), which also constitute counter-evidence to (4.213). The whole problem of what syntactic properties various types of idioms have has been neglected grievously -- I suspect that intensive research into this problem would yield rich rewards for many areas of syntax besides this one.

In Danish, there are many environments in which pied piping is blocked. Thus, while the preposition på 'in' can be left behind or moved to the front of the sentence, when a manner adverb is questioned (cf. (4.223)),

- (4.223) a. Hvilken måde gjorde han det på?
 which way did he it in
 'How did he do it?'
 b. På hvilken måde gjorde han det?
 In which way did he it

prepositions in a prepositional phrase which is immediately dominated by VP can never be moved to the front of the sentence: (4.224c) is

ungrammatical.

- (4.224) a. Han fandt på den historie.
 he invented that story
- b. Hvilken historie fandt han på?
 which story invented he
 'Which story did he invent?'
- c. * På hvilken historie fandt han?

This means that in the grammar of Danish, the following condition must be stated:

- (4.225) No NP with the analysis $[P\ NP]_{NP}$
 may be moved if it is immediately
 dominated by VP.

The full set of facts in Danish is quite a bit more complex -- a more detailed presentation is given in Blass (1965). I will not attempt a recapitulation of all the facts of Danish, for my purpose here is not to suggest a complete analysis of all constructions involving prepositions in Danish or in English, but merely to demonstrate that just as there are environments where pied piping is obligatory (cf. § 4.3.2.1. above), so there are environments where it must be blocked.

4.3.2.3. The first condition on pied piping, (4.181), prevents the reordering of an NP on a left branch of the larger NP, no matter in which direction the NP being reordered is to move. Thus

neither the rule of Topicalization, which moves noun phrases to the left, nor the rule of Complex NP Shift, which moves them to the right, can apply to NP₃ or NP₂ in tree (4.183), as the ungrammatical sentences of (4.187) and (4.188) demonstrate. And the same is true of the other conditions stated in § 4.3.2.1 -- (4.200) and (4.206). The first of these asserted that it is impossible to "strand" a preposition in German, and various other languages, by moving its object NP away from it. Thus, in German, when the NP diesen Kasten 'this box' in (4.226a) is questioned, it cannot be moved to the front of the sentence alone, as would be possible in English, (cf. the ungrammaticality of (4.226b)). When the Question Rule applies, (4.200) requires that the larger NP, in welchen Kasten, 'into which box' be preposed, as it is in (4.226c)

(4.226) a. Vladimir wollte das Buch [in [diesen
Vladimir wanted the book into this
Kasten]_{NP}]_{NP} schmeissen.

box throw.

'Vladimir wanted to throw the book into
this box.'

b. * Welchen Kasten wollte Vladimir das Buch

Which box wanted Vladimir the book

in schmeissen?

into throw?

- c. In welchen Kasten wollte Vladimir das
 into which box wanted Vladimir the
 Buch schmeissen?
 book throw
 'Into which box did Vladimir want to throw
 the book?'

Just as it is impossible to strand a preposition in German by moving its object NP away from it to the left, so it is impossible to do so by moving the NP to the right. An example of a rule which moves NP to the right in German is the rule which converts sentences like (4.227a) into ones like (4.227b), which, though marginal, must be generated.

- (4.227) a. Er wollte denen ein wunderbares Bilderbuch geben.
 he wanted to them a wonderful picture book give.
 'He wanted to give them a wonderful picture book.
 b. Er wollte denen geben ein wunderbares Bilderbuch.

This rule corresponds roughly to the English rule of Complex NP Shift, although the English rule is not so restricted as the German one. Since I have not studied the conditions under which such sentences as (4.227b) can be produced, I will not attempt a precise statement of the rule here; the formulation of Complex NP Shift which was given in (3.26) is adequate for my present purpose.

Note that Complex NP Shift, if applied to (4.226a), can only move the larger NP, in diesen Kasten (cf. (4.228)). If the

object of the preposition is moved, the impossible (4.228b) results.

- (4.228) a. Vladimir wollte das Buch schmeissen
in diesen Kasten.
- b. * Vladimir wollte das Buch in schmeissen
diesen Kasten.

This shows that (4.200), just like (4.181), constrains transformations which move NP to the right, as well as those which move NP to the left.

In English, however, we find a different situation. While prepositions may be stranded if their object NP is moved to the left, they may not be if it is moved to the right. The rule of Topicalization may strand the preposition to of (4.229a), as in (4.229b), or it may take it along, as in (4.229c).

- (4.229) a. Mike talked to my friends about politics
yesterday.
- b. My friends Mike talked to about politics
yesterday.
- c. To my friends Mike talked about politics
yesterday.

But Complex NP Shift cannot apply to the NP my friends in (4.229a): it can only apply to the larger NP to my friends.

- (4.230) a. Mike talked about politics yesterday to
my friends.
- b. * Mike talked to about politics yesterday
my friends.

Thus it can be seen that the theory of grammar must be strengthened so that conditions making pied piping obligatory or impossible can make reference to the direction in which the specified NP is to be reordered. It will be necessary to add to English condition (4.231), which is a weaker form of (4.200).

(4.231) No NP may be moved to the right out
of the environment [P ___]_{NP}.

It might appear that (4.213) would have to be modified along these lines, in the light of such sentences as those in (4.232),

(4.232) a. ? They got wind, eventually, of the counter-plot to fluoridate the bagels.

b. ? Carrie did away, systematically, with her nephews from Chattanooga.

c. ??She made light, not too surprisingly, of the difficulties we might have at the border.

d. ? I got hold, fortunately, of Lady Chatterley's ex.

for superficially at least, the prepositional phrases which follow V - A syntactic idioms of the type discussed in connection with (4.213) seem to have been moved, possibly by the rule of Complex NP Shift. I suspect, however, that (4.213) does not have to be modified and that some other rule than Complex NP Shift is being used in the generation of the sentences in (4.232). The rule in question is probably related to the Scrambling Rule, (3.48); it allows sentence adverbs to be

positioned between any major constituents of a clause.²⁸ Note that the sentences in (4.232) are almost totally unacceptable if the commas are removed, but that no commas are necessary in such clear cases of Complex NP Shift as (4.233).

(4.233) I gave to the officer in charge the
blackjack which I had found in the
cookie jar.

The sentences in (4.232) thus seem to be accountable for by other means than assuming the existence of a second condition on pied piping like (4.231), a condition in which the direction of reordering would make a difference. So, although I know of no other facts which motivate the postulation of any other direction-dependent conditions, the facts discussed in connection with (4.231) seem to require, at least for the present, a theory of language in which such conditions can be stated.

4.3.2.4. In this section, I will point out one puzzling fact about the interaction between the rule of Conjunction Reduction and two of the conditions on pied piping which were discussed above -- the Left Branch Condition and (4.231).

In § 4.2.4.1, I gave a brief, informal description of the rule which converts (4.118) into (4.119). Since the adjective pregnant appears on a right branch of both conjoined sentences in (4.118), it can be raised and Chomsky-adjoined to the coordinate node

by the rule of Conjunction Reduction. The same is true of the two occurrences of the NP a successful outing at the track in (4.234), as the grammaticality of (4.235) shows.

(4.234)

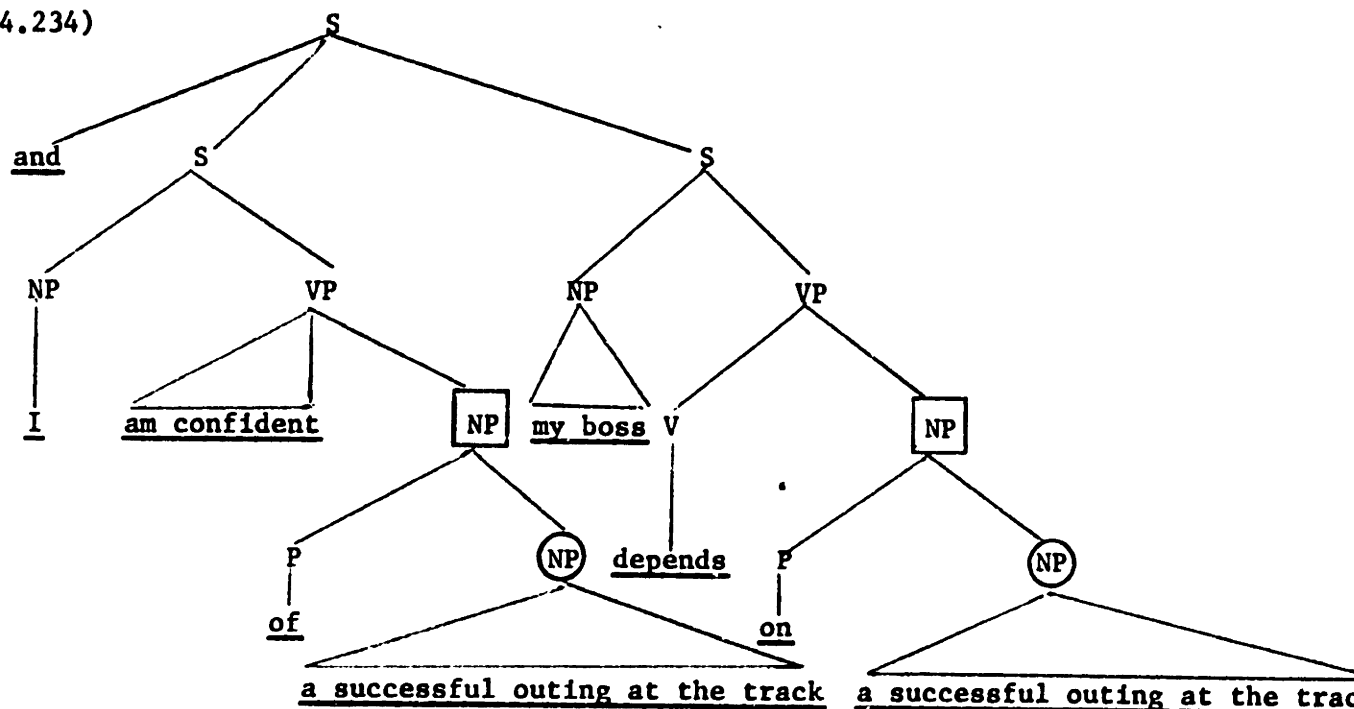

(4.235) I am confident of, and my boss depends on,
a successful outing at the track.

Since (4.235) is grammatical, some condition must be built into (4.231) which weakens it so that it does not affect the operation of the rule of Conjunction Reduction. As (4.231) is now stated, it would prevent the circled NP nodes in (4.234) from being raised, for they are contained in the boxed NP nodes, which start with

prepositions. I do not understand why (4.231) should not constrain Conjunction Reduction, for it is not in general true that conditions on pied piping do not apply to Conjunction Reduction, as the following example will show.

Up to this point, I have only discussed examples of the operation of Conjunction Reduction where the identical constituent was on a right branch, but the rule will also work on constituents which appear on left branches. Thus in (4.236), the circled noun phrases can be Chomsky-adjoined to the coordinate node -- the result is sentence (4.237).

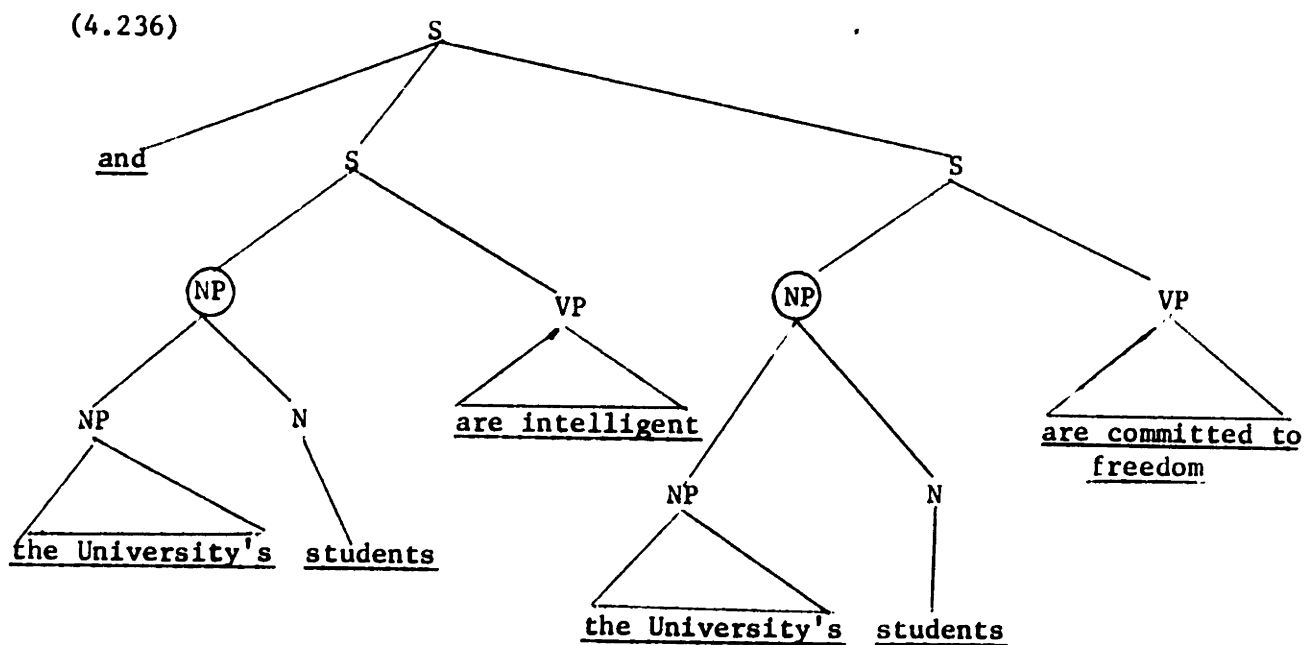

(4.237)

The University's students are intelligent
and (are)²⁹ committed to freedom.

But note that if the input structure is that shown in (4.238), Conjunction Reduction must be blocked.

(4.238)

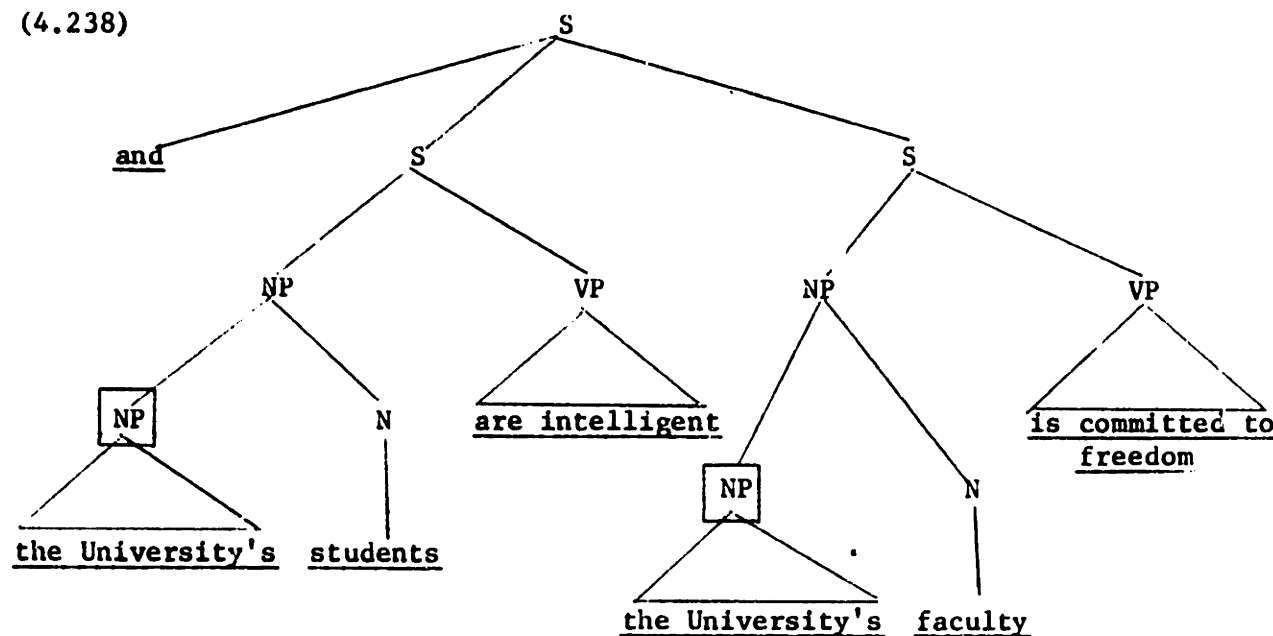

The only identical nodes in (4.238) are the two occurrences of the boxed NP the University's. If Conjunction Reduction is allowed to apply to these nodes, the ungrammatical (4.239) results:

(4.239) * The University's students are intelligent
and faculty is committed to freedom.

It is not necessary to add any condition to the rule of Conjunction Reduction to avoid generating (4.239): the Left Branch Condition, (4.181), will prevent the boxed NP's in (4.238) from being raised, because each is on the left branch of a larger NP. These facts are indicative clearly that it is not in general the case that conditions

on pied piping are not in effect for the rule of Conjunction Reduction, so it will be necessary to add a clause to condition (4.231), stating that this particular condition does not apply to the rule of Conjunction Reduction.

For some reason, there is one environment in which (4.181) also behaves idiosyncratically with respect to Conjunction Reduction -- even though the constituents to be raised are on the left branches of larger NP's, these constituents can be raised, if the larger NP's are conjuncts of a coordinate NP. For example, the two circled NP nodes in (4.240) can be raised and adjoined to the boxed NP node, yielding (4.241).

(4.240)

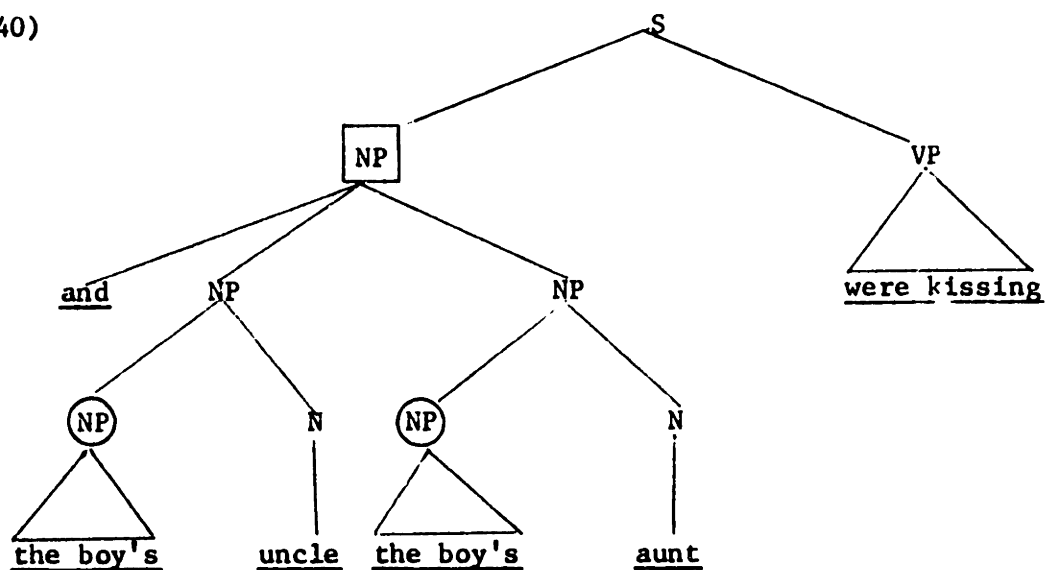

(4.241)

The boy's uncle and aunt were kissing.

It is not necessary that the NP being raised and adjoined be immediately dominated by a conjunct: the NP shown in (4.242a) can be reduced to the one shown in (4.242b), by raising the two occurrences of the NP the boy's.

(4.242) a.

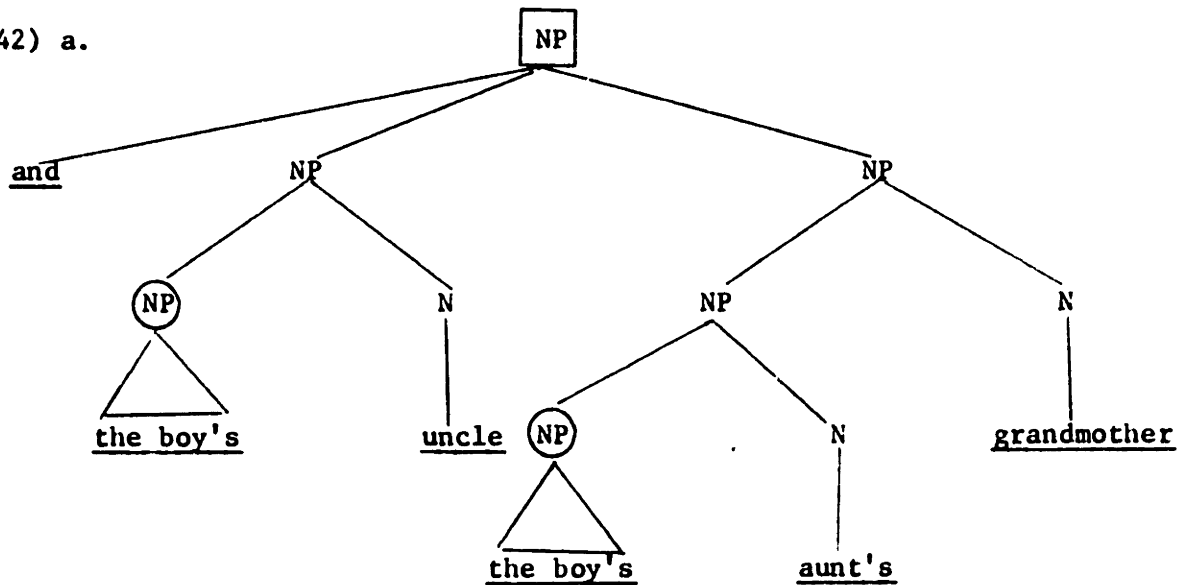

b.

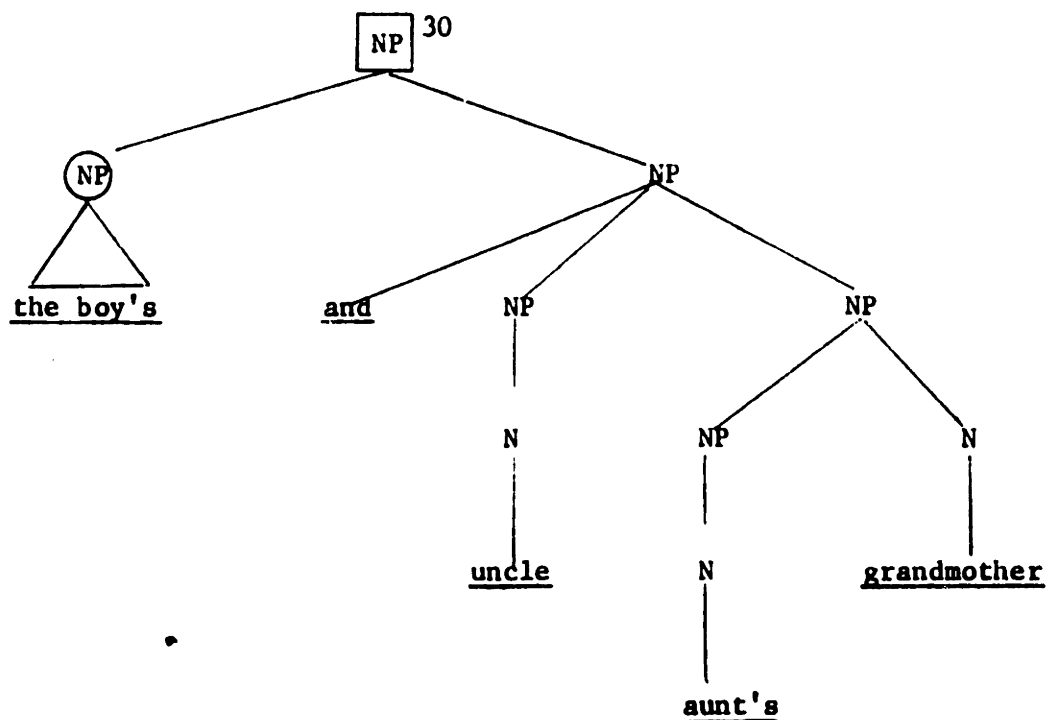

I can think of no explanation for this strange fact -- it will simply have to appear as an ad hoc rider on (4.181). However, this rider can be used to explain the otherwise extremely puzzling difference between the grammatical (4.243a) and the ungrammatical (4.243b).

- (4.243) a. The boy whose uncle and aunt's grandmother were kissing was furious.
- b. * The boy whose uncle and Tom's aunt's grandmother were kissing was furious.

The relative clause in (4.243a) comes from a sentence whose subject is the NP shown in (4.242a). If Conjunction Reduction applies before Relative Clause Formation, thus converting (4.242a) into (4.242b), then the circled NP the boy's in (4.242b) will be relativizable, because it will then no longer be contained in a coordinate structure. Since it is on the left branch of the boxed NP, when it moves, this larger NP will pied pipe with it, as (4.181) requires.

But the relative clause in (4.243b) would have the NP shown in (4.244) as its subject:

(4.244)

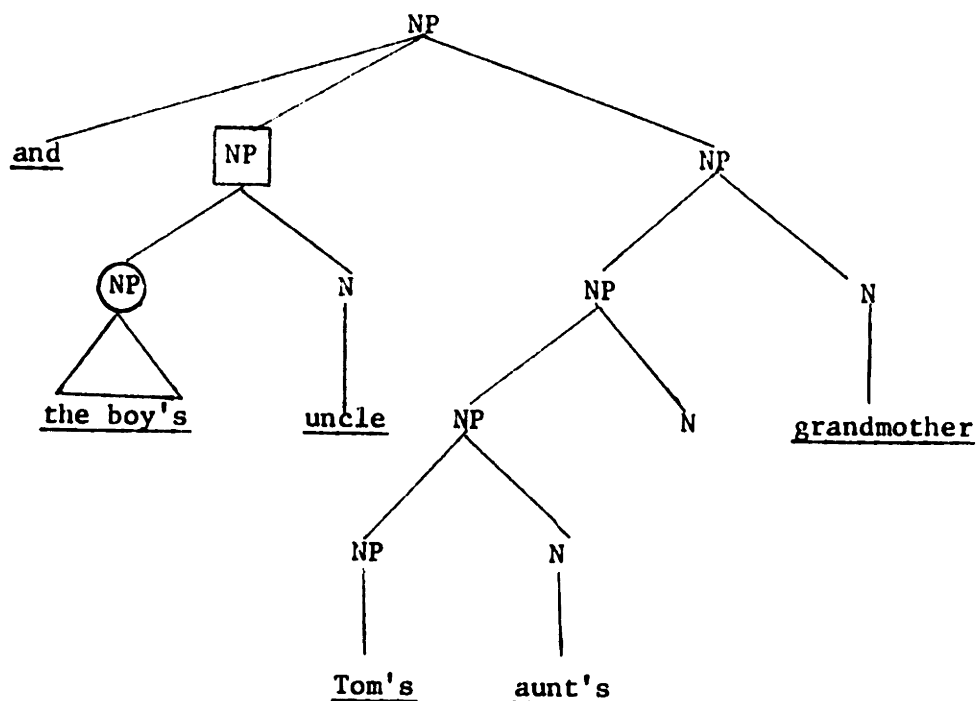

Since the circled NP in this tree does not occur in all conjuncts, the rule of Conjunction Reduction cannot apply to it. Therefore, when relativization of this NP is attempted, (4.181) will specify that the boxed NP node in (4.244) must pied pipe, for the NP being relativized is on its left branch. But the boxed NP is a conjunct, and thus cannot be moved, by virtue of the Coordinate Structure Constraint, (4.84). And since there is a clause in the Pied Piping Convention, (4.180), which specifies that coordinate nodes cannot pied pipe (recall the ungrammaticality of (4.172)), the top NP node of (4.244) will not pied pipe either. Thus the circled NP node is frozen solidly in position -- (4.181) prevents it from reordering, and the way (4.84) and (4.181) have been stated prevent any NP node

above it from pied piping -- so the rule of Relative Clause Formation, if it applies to this circled NP, will produce an ungrammatical sentence. The contrast between the sentences in (4.243) is thus only to be explained on the basis of quite far-reaching theoretical constructs.

4.3.2.5. What is the theoretical status of constraints like (4.181), (4.200), (4.206), (4.213), (4.225) and (4.231)? It is obvious that (4.200), which prohibits the stranding of prepositions, is not universal, for prepositions may in general be stranded in English. (4.206), which prevents the stranding of prepositions the head of whose objects is not pronominalizable, is not universal either, for prepositions can be stranded in this environment in Danish, as (4.223a) shows. (4.225) is not universal, for the prepositions of English prepositional phrases directly dominated by VP can be stranded, as (4.245) shows.

(4.245) Who are you gawking at?

It may be that (4.231) is universal -- I know of no counterexamples at present.

The Left Branch Condition, although it is in effect in such languages as English, German, French, Danish, Italian and Finnish, is not universal, for it is not in effect in Russian and Latin. In Russian, the possessive adjective čuju 'whose' can be preposed in questions, whether or not the noun it modifies appears with it at

the front of the sentence.

- (4.246) a. Čuju knigu ty čitaješ?
 Whose book you are reading
 'Whose book are you reading?'
- b. Čuju ty čitaješ knigu?
 Whose you are reading book
 'Whose book are you reading?'

The same applies to the interrogative adjective skolko 'how many', as can be seen in (4.247).

- (4.247) a. Skolko let u nim byli?
 how many years to him were
 'How many years old was he?' (=how many
 years did he have?)
- b. Skolko u nim byli let?
 how many to him were years
 'How many years old was he?'

In Latin, too, sentences which parallel (4.246b) can be found - cf. (4.248).

- (4.248) Cuius legis librum?
 whose you are reading book
 'Whose book are you reading?'

As far as I know, it is only in highly inflected languages, in whose grammars the rule of Scrambling appears, that the Left Branch Condition is not operative, but it is not the case that it is not operative in

all such languages. In Finnish, for example, sentences like (4.248) are not possible. At present, therefore, I am unable to predict when a language will exhibit the Left Branch Condition and when not.

Thus it appears that with the possible exception of (4.231), all of the constraints on pied piping which were discussed in §§ 4.3.2.1 - 4.3.2.4 must be stated in the grammar of each language that exhibits them. But must each such condition be stated on each rule which it influences? Must the Left Branch Condition be built into the English rules of Relative Clause Formation, Appositive Clause Formation, Topicalization, Complex NP Shift and Question? To repeat the Left Branch Condition on each of these five rules is to make the claim that it is an accidental fact about this particular set of five rules that they are all subject to (4.181). I am making the opposite claim: that any reordering transformation would be subject to (4.181). To reflect this claim formally, the theory of grammar must be changed. At present, the theory only permits conditions which are stated on particular rules, like the identity condition on Relative Clause Formation, or meta-conditions, like the Complex NP Constraint, which are stated in the theory. But the constraints on pied piping which are under discussion cannot be correctly accommodated under either of these possibilities: they are not universal, and to state them on each transformation which they affect is to miss a generalization. What is necessary is that the grammar of every natural language be provided with a conditions box, in which all such language-

particular constraints are stated once for the whole language. By a universal convention of interpretation, all conditions in the conditions box will be understood to be conditions on the operation of every rule in the grammar.

To give some concrete examples, for English, the conditions box will contain, among others, (4.181), (4.206), (4.213) and (4.231). For French, Italian and German, it will contain (4.181), (4.200) and (4.231). It should not be thought that only conditions on pied piping will appear in this box. In Finnish, for example, it is the case that no element can be moved out of complement clauses which are introduced by että 'that'. That is, while such sentences as (4.249a) are possible in English, no corresponding sentence is possible in Finnish, as the ungrammaticality of (4.249b) shows.

- (4.249) a. Which hat do you believe (that) she never wore?
- b. * Mitä hattua uskoit ettei hän
which hat you believed that not she
koskaan käyttänyt?
ever used.

Thus far, with one exception, which I will discuss in footnote 15 of Chapter 5, all the constraints which I know to appear in the conditions box of any language are constraints on reordering transformations, but there is of course no reason to expect that no

other types of constraints will be found to occupy condition boxes in other languages.

4.3.3. To recapitulate the discussion of pied piping, the existence of structures like (4.162), which allow for an in principle unbounded number of relative clauses to be formed, clearly indicates the need for a convention of some sort. Rather than devise some notational convention under which an infinite family of rules like those in (4.135), (4.164) and (4.165) could be abbreviated by some sort of finite schema -- a notational convention which would only be made use of to handle these facts, I have chosen the convention stated in (4.180), which, though still somewhat ad hoc, is weaker than a new notational convention would be, and thus yields a more restrictive characterization of the class of possible transformations, and hence of the notion of natural language. In § 4.3.2 I discussed a number of cases where pied piping is obligatory and suggested that the theory of grammar be changed so that every particular grammar contains a conditions box in which constraints of various types, which affect all rules of the grammar, can be stated. Such constraints are intermediate in generality between particular conditions on particular rules and meta-constraints like the Complex NP Constraint and the Coordinate Structure Constraint.

4.4. The Sentential Subject Constraint

4.4.1. Compare (4.250a) with its two passives, (4.250b) and (4.250c).

- (4.250) a. The reporters expected that the principal would fire some teacher.
- b. That the principal would fire some teacher was expected by the reporters.
- c. It was expected by the reporters that the principal would fire some teacher.

Noun phrases in the that-clauses of (4.250a) and (4.250c) can be relativized, but not those in the that-clause of (4.250b), as (4.251) shows.

- (4.251) a. The teacher who the reporters expected that the principal would fire is a crusty old battleax.
- b. * The teacher who that the principal would fire was expected by the reporters is a crusty old battleax.
- c. The teacher who it was expected by the reporters that the principal would fire is a crusty old battleax.

How can (4.251b) be blocked? A first approximation would be a restriction that prevented constituents of subject noun phrases from reordering, while allowing constituents of object noun phrases

to do so. But such a restriction would be too strong, as can be seen from the grammaticality of (4.252).

(4.252) Of which cars were the hoods damaged by
the explosion?

The approximate structure of (4.252), at the time when the Question Rule applies, is that shown in (4.253).

(4.253)

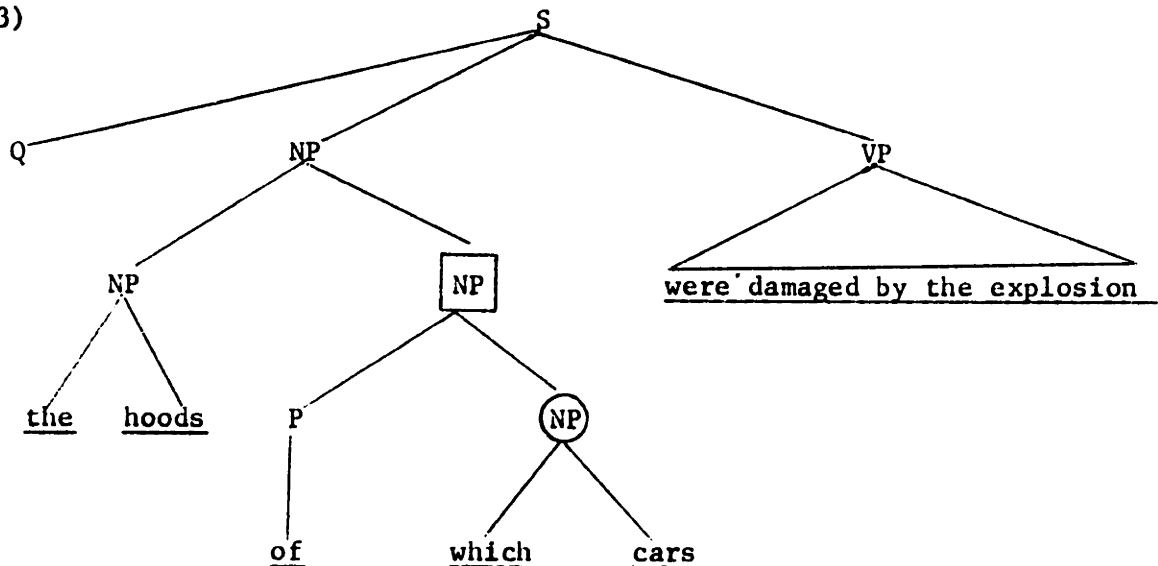

It can be seen that in converting (4.253) to the structure which underlies (4.252), the boxed NP, a constituent of the subject of (4.253), has been moved to the front of the sentence, so the suggested restriction is too strong.³¹ But there is an obvious difference between (4.252) and the ungrammatical (4.251b): the subject of the latter sentence is a clause, while the subject of the former is only a phrase. The condition stated in (4.254) takes this difference into account.

(4.254) The Sentential Subject Constraint

No element dominated by an S may be moved out of that S if that node S is dominated by an NP which itself is immediately dominated by S.

This constraint, though operative in the grammars of many languages other than English, cannot be stated as a universal, because there are languages whose rules are not subject to it. In Japanese, for instance, although the circled NP in (4.256), which is the approximate structure of (4.255), falls within the scope of (4.254), it can be relativized, as the grammaticality of (4.257) shows.

- (4.255) Mary ga sono boosi o kabutte ita koto
 Mary that hat wearing was thing
 ga akiraka da.
 obvious is
 'That Mary was wearing that hat is obvious.'

(4.256)

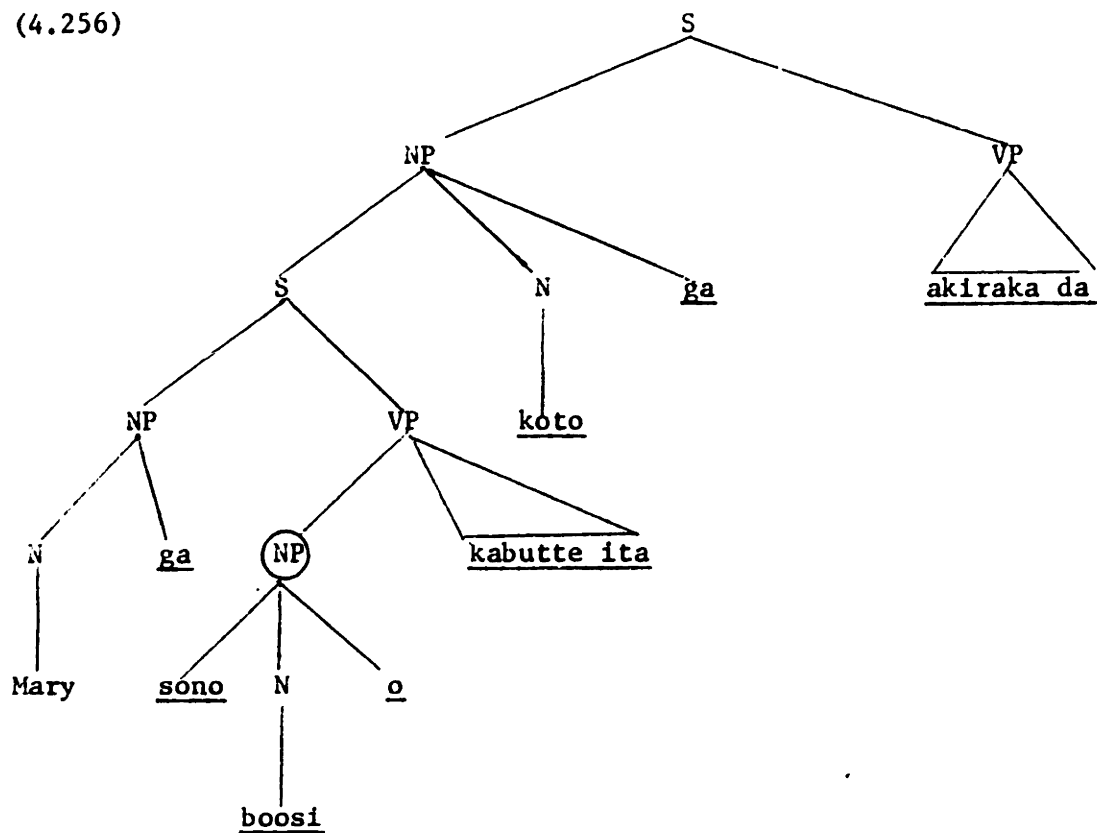

(4.257)

Kore wa Mary ga kabutte ita koto ga

this Mary wearing was thing

akiraka na boosi da.

obvious is hat is.

'This is the hat which it is obvious that

Mary was wearing.'

That the languages whose rules I know to be subject to

(4.254) far outnumber those whose rules are not so constrained suggests that a search be made for other formal properties of these latter languages which could be made use of to predict their atypical behavior

with respect to this constraint. At present, however, whether or not (4.254) is operative within any particular language can only be treated as an idiosyncratic fact which must be stated in the conditions box of the language in question.

4.4.2. George Lakoff has pointed out to me that on the basis of only the facts considered so far, it would be unnecessary to state the Sentential Subject Constraint, for it is a special case of (3.27), the output condition which makes sentences containing internal $[_{NP^S}]_{NP}$ unacceptable. Thus, since (4.251b) contains the internal clause that the principal would fire, and since this clause is dominated exhaustively by NP, condition (3.27) would account for its unacceptability. But the two arguments below seem to me only to be accountable for if condition (4.254) is assumed to be operative in the grammar of English.

Firstly, consider sentence (4.258), and its associated constituent structure (4.259).

(4.258) That I brought this hat seemed strange to
the nurse.

(4.259)

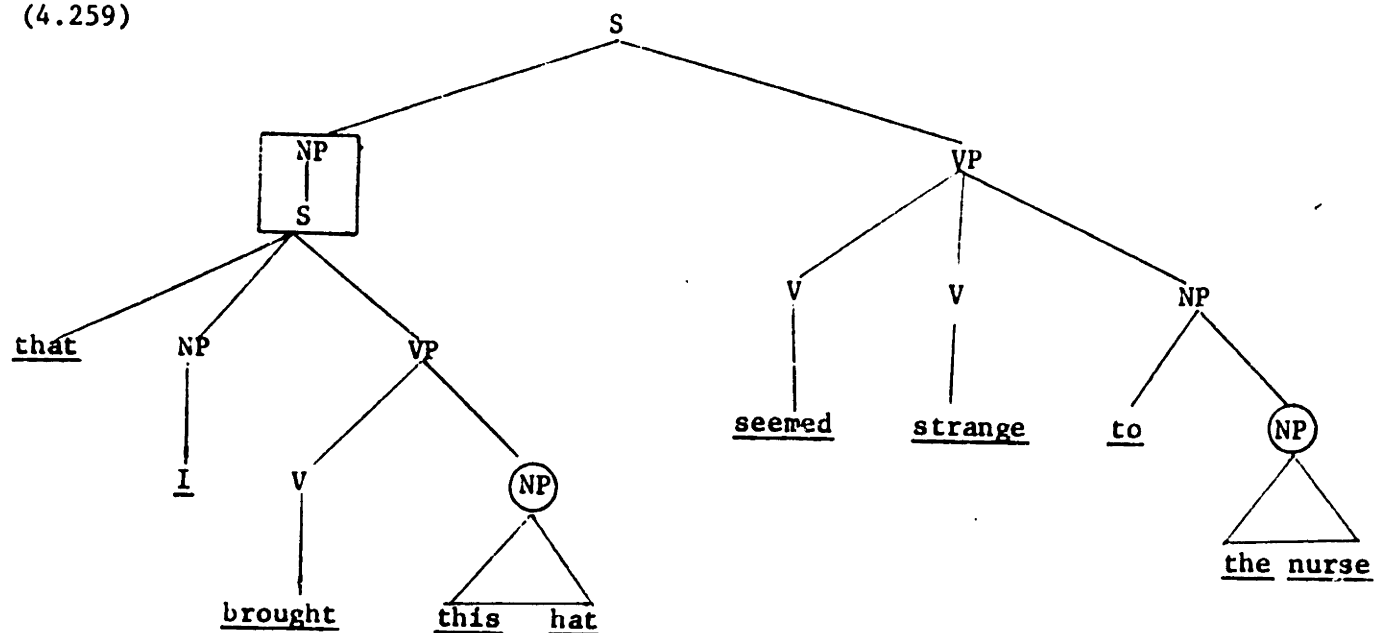

Relativizing either of the circled 'NP's in (4.259) will produce sentences which are not fully acceptable (cf. (4.260)),

(4.260) a. * The hat which that I brought seemed strange to the nurse was a fedora.

b. ? The nurse who that I brought this hat seemed strange to was as dumb as a post.

because both relative clauses in (4.260) will contain the boxed NP over S of (4.259) as an internal constituent. Condition (3.27) will be adequate to characterizing both as being unacceptable, but it will not be able to account for the clear difference in status between (4.260a) and (4.260b). The latter sentence is admittedly awkward, but it can be read in such a way as to be comprehensible. The former

sentence, however, seems to me to be beyond intonational help. I conclude that (4.260b) should be labeled grammatical but unacceptable, but that (4.260a) must be deemed ungrammatical. To do this, (4.254), or some more general constraint, must be assumed to be operative in English, as well as (3.27).

The second argument for (4.254) concerns the following two sentences:

- (4.261) a. I disliked the boy's loud playing of the piano.
- b. I disliked the boy's playing the piano loudly.

Lees gives a number of arguments which show these to be different.³² I will assume that the derived structure of (4.261a) is that shown in (4.262), and that of (4.261b) is that shown in (4.263).

(4.262)

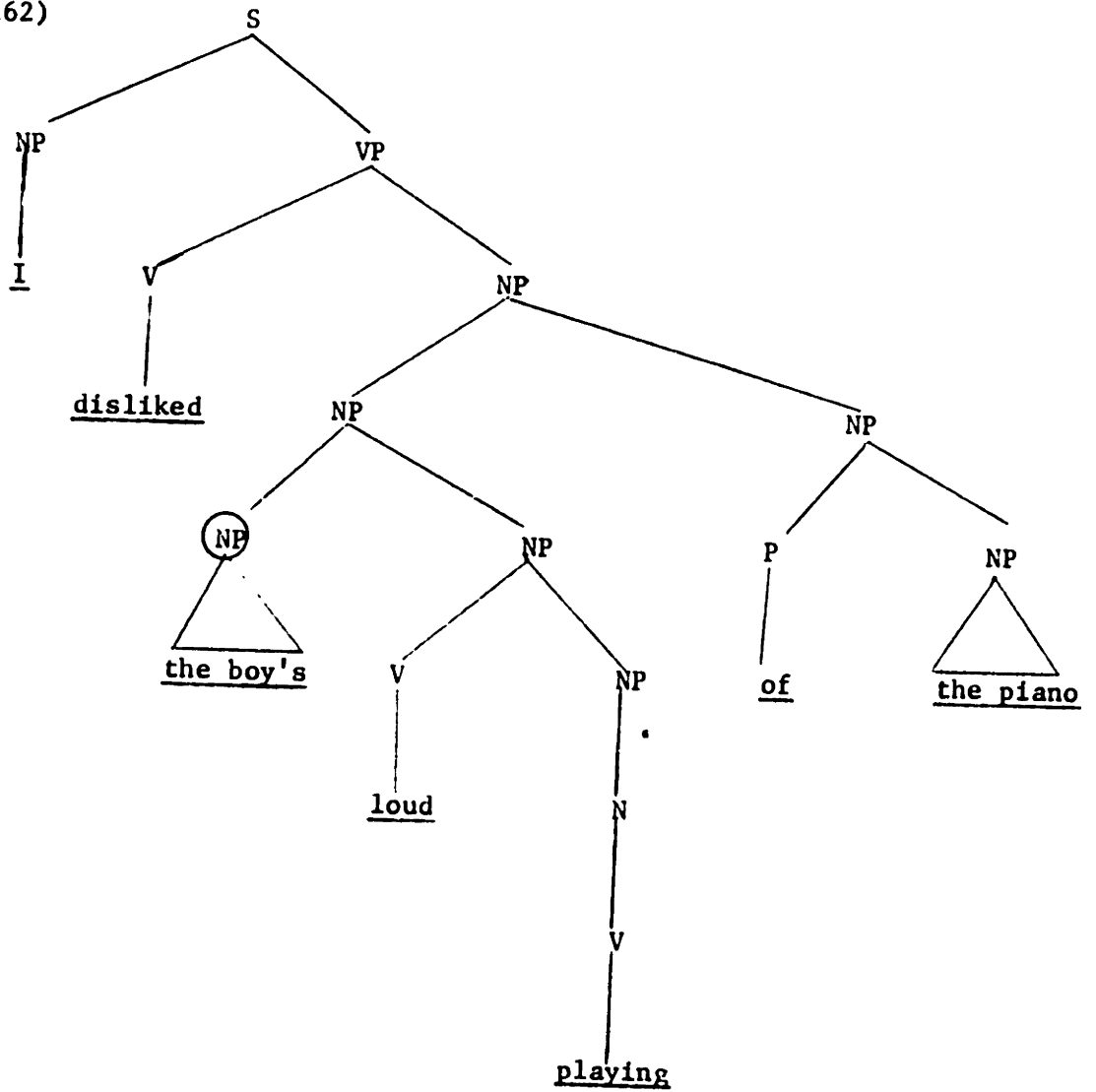

(4.263)

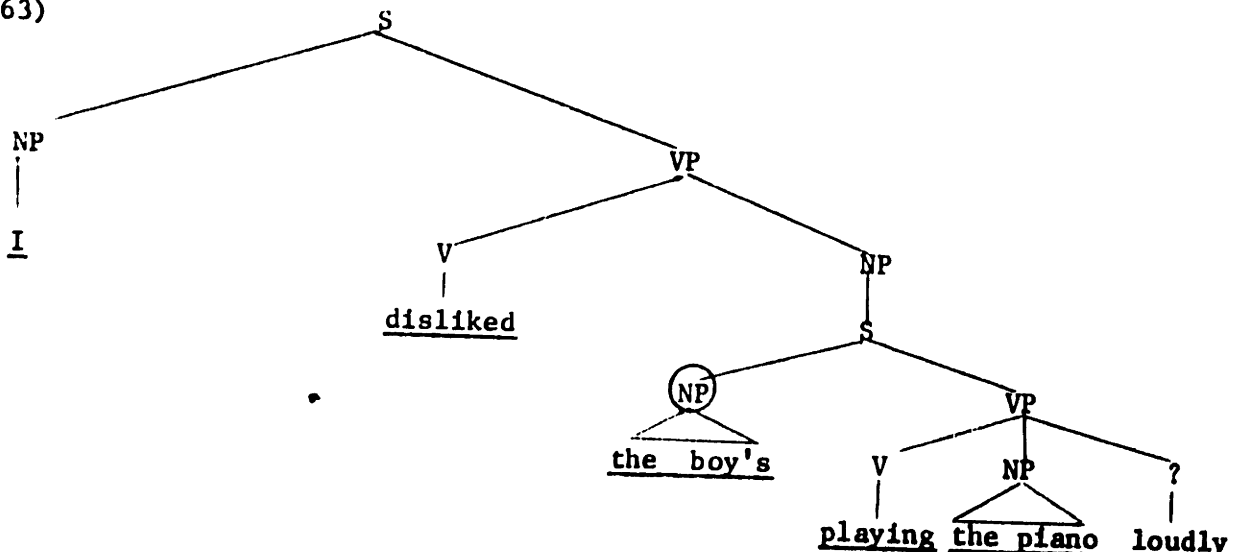

I have assumed that the word playing in (4.262) has the derived status of a noun, to account for the appearance of the preposition of before the object of playing, parallel to the of which occurs after such substantivized verbs as construction, refusal, fulfillment, etc. (cf. his construction of an escape hatch, our refusal of help, her fulfillment of her contract).

That the latter structure has a clausal object, while the former does not, can be seen from the difference in relativizability of the circled NP's in (4.262) and (4.263). This NP can be relativized in the former structure (cf. (4.264a)), but not in the latter (cf. the ungrammaticality of (4.264b)).

- (4.264) a. The boy whose loud playing of the piano
I disliked was a student.
- b. * The boy whose playing the piano loudly
I disliked was a student.

Although the circled NP of (4.262) is on a left branch of an NP when the Relative Clause Formation Rule applies, pied piping can be invoked to effect the adjunction of the boxed NP to the node S which dominates the clause, so a well-formed relative clause will result.

But in (4.263), if the circled NP is moved, the boxed NP cannot pied pipe, because there is a node S which intervenes between the two NP nodes, and under these conditions, pied piping

cannot take place, as was pointed out in § 4.3.1 above.

Note that the object NP of playing, the piano, is relativizable in both (4.262) and (4.263).

- (4.265) a. ? The piano which I disliked the boy's
loud playing of was badly out of tune.
b. The piano which I disliked the boy's
playing loudly was badly out of tune.

But if the action nominal or the factive gerund nominal appears in subject position, as in (4.266), the NP the piano can only be relativized out of the action nominal as (4.267) shows.

- (4.266) a. The boy's loud playing of the piano drove
everyone crazy.
b. The boy's playing the piano loudly drove
everyone crazy.

- (4.267) a. That piano, { which the boy's loud playing of
the boy's loud playing of which }
drove everyone crazy, was badly out of tune.
b. * That piano, { which the boy's playing loudly
the boy's playing which loudly }
drove everyone crazy, was badly out of tune.

How can (4.267b) be excluded? The bottom line of (4.267b) can be blocked on the same grounds as (4.264b): since the subject NP of (4.266b) dominates the node S, pied piping cannot take place. But unless (4.454), the Sentential Subject Constraint, is added to the grammar, the top line of (4.267b) will not be excluded. Note that

even condition (3.27) cannot be invoked here, because this condition must be reformulated as shown in (4.268).

- (4.268) Grammatical sentences containing an internal NP which exhaustively dominates an S are unacceptable, unless the main verb of that S is a gerund.

This reformulation is necessary in any case, in order to account for the difference in acceptability between (4.269a) - (4.269c) and (4.269d).

- (4.269) a. * Did that he played the piano surprise you?
 b. * Would for him to have played the piano have surprised you?
 c. * Is whether he played the piano known?
 d. Did his having played the piano surprise you?

Thus it appears that there are two reasons for insisting that both (4.268), the revised version of (3.27), and the Sentential Subject Constraint be included in the grammar of English. In the first place, condition (4.268) is not adequate to distinguish between (4.260a) and (4.260b), and in the second, between (4.267a) and (4.267b). These two facts indicate the necessity of adding to the conditions box of English something at least as strong as (4.254).

4.4.3. It will be remembered, in connection with (4.249), that in the conditions box for Finnish, there is a constraint which prevents elements of clauses headed by että 'that' from being moved out of these clauses (cf. the ungrammaticality of (4.249b)).

In her recent paper (Dean (1967)), Janet Dean has pointed out a condition in English that is probably related to the Finnish condition. There is a class of verbs in English which can take that-clauses as objects but for which the rule which normally can optionally delete the that-complementizer cannot apply. After believe, for example, the complementizer is optional (cf. (4.249a)), but after verbs like quip, snort, rejoice, etc., the complementizer must be present, as the ungrammaticality of (4.270b) shows.

- (4.270) a. Mike quipped that she never wore this hat.
 b. * Mike quipped she never wore this hat.

Dean discovered that no element of the complement clauses of these verbs can be moved out of them (cf. the ungrammaticality of (4.271)).

- (4.271) a. * Which hat did Mike quip that she never wore?
 b. * Which girl did Mike quip never wore this hat?

It is not clear at present how these facts should be handled. It may be possible to assume that the English conditions box, like the Finnish one, contains the constraint that no element may be moved out of that-clauses, and that the object clauses of verbs like believe do not come to be headed by that until after all reordering transformations have applied, while the object clauses of

verbs like guip are prefixed by that at a very early stage in derivations. This then raises the possibility that the condition that no element be moved out of a that-clause need not be stated in the conditions boxes of Finnish and English, but is instead universal. Dean has suggested (op. cit.) that this condition is only a subcase of a far more general condition, (4.272).

(4.272) No element of a subordinate clause may be moved out of that clause.

There are several difficulties with this condition which at present prevent me from accepting it. The first is that it is not strong enough to explain the differences among the sentences in (4.251), and would therefore seem to have to be supplemented by the Sentential Subject Constraint. The second is that (4.272) would incorrectly exclude all the sentences of (2.23), which differ among themselves in acceptability, but some of which seem perfectly normal to me. And the third objection is that elements of clauses with Poss - Ing or for - to complementizers can be relativized, as can be seen from the grammaticality of (4.265b) and (4.273).

(4.273) The only hat which it bothers me for her to wear is that old fedora.

That such phrases must be considered to be dominated by S follows from the fact that Reflexivization cannot "go down into" them (cf. the ungrammaticality of (4.274)),

- (4.274) a. * I dislike it for him to tickle myself.
 b. * I dislike his tickling myself.

from the fact that elements of these clauses can undergo "backwards" pronominalization (cf. (4.275)),³³

- (4.275) a. For Anna to tickle him drives Frank crazy.
 b. Anna's tickling him drove Frank crazy.

and from my proposed explanation of the difference in acceptability between the sentences of (4.264). This last objection cannot be gotten around by modifying (4.272) by attaching a condition that the main verb of the subordinate clause be finite, for no elements of the infinitival and gerund clauses in sentences like (4.276) can be moved, as the ungrammaticality of (4.277) shows.

- (4.276) a. We donated wire for the convicts to build cages with.
 b. They are investigating all people owning parakeets.

- (4.277) a. * The cages which we donated wire for the convicts to build with are strong.
 b. * What kind of parakeets are they investigating all people owning?

These three arguments against Dean's proposed constraint strike me at present as being strong enough to reject it for the time being. It is, however, a bold and important hypothesis, for if it can be established, it will make my Complex NP Constraint and Sentential

Subject Constraint superfluous, thus substantially simplifying both the theory of language and those grammars in which the latter constraint is operative. For this reason, a lot of future research should be directed at the three objections to (4.272) which I have discussed, to see if they can satisfactorily be explained away.

4.5. To summarize briefly, in this chapter I have proposed two universal constraints, the Complex NP Constraint and the Coordinate Structure Constraint; also, a universal convention of pied piping; and a variety of language particular constraints, which are to be stated in particular grammars in a conditions box, which the theory of language must be revised to provide. I make no claim to exhaustiveness, and I am sure that the few conditions I have discussed are not only wrong in detail, but in many major ways. Not only must further work be done to find other conditions, but to find broader generalities, such as the condition proposed by Dean, so that the structure of whatever interlocking system of conditions eventually proves to be right can be used with maximum effectiveness as a tool for discovering the structure of the brain, where these conditions must somehow be represented.

1. Subscripts indicate identity of reference.
2. This term is defined in Ross (1967a). There I argue that pronouns may only precede the NP they refer to if they are dominated by a subordinate clause which does not dominate that NP. Cf. also § 5.3 below.
3. Evidence that this rule must be placed late in the rule ordering is given in Lakoff and Ross (op. cit.). Cf. also § 5.1.1 below.
4. The Japanese words wa, ga, o, ni, etc. have been called "particles". They correspond very roughly to case endings and prepositions. Ga and wa are adjoined by transformations to the right of subject noun phrases, o to the right of ni to the right of direct objects, ni to the right of agent phrases etc. The syntax of these postpositional particles and other problems in Japanese syntax have been investigated intensively by Kuroda (cf. Kuroda (1965)), and I will not discuss it further here. In the word-for-word glosses of Japanese examples, I will leave the particles untranslated.
5. The structure shown in (4.25) is vastly oversimplified and the analysis of tabete iru 'is eating' is simply wrong: actually iru should be the main verb of a higher sentence into which

the base string kodomo sakana tabe 'child fish eat (stem)' would be embedded. Also, the determiner sono 'that' would probably not appear as a constituent of the deep structure of (4.24), but rather as a feature on the noun sakana 'fish' in the matrix sentence. But such niceties are not at issue here - (4.25) will serve for the purpose at hand.

6. Postal made this proposal in a talk given at the LaJolla Conference on English Syntax on February 25, 1967.
7. Professor Barbara Hall Partee has informed me (personal communication) that in a survey of relative clause constructions in a wide variety of languages that she conducted, she found that in languages which exhibit relative pronouns which have been moved from their original position, these pronouns invariably appear at the end of the relative clause closest to the head noun. Relative pronouns thus move leftwards in English, German, French, etc., and although I at present can cite no examples of rightward movement, Professor Partee has assured me that they exist. It therefore seems necessary to assume that if movement occurs in the formation of Japanese relative clauses, it must be movement to the right, not to the left.

These facts point to a needed change in the theory of grammar. In order to account for the facts discovered by Professor Partee, it is necessary to add to linguistic theory a convention for automatically reordering the formal statement of transformational rules. If such a convention is made available, the statement in universal grammar of a relative clause skeleton rule will be possible, for the rule of Relative Clause Formation in Japanese is simply the mirror image of the rule shown in (4.2). In which direction the rule will reorder constituents depends entirely upon whether relative clauses are generated by the rule $NP \rightarrow NP S$ or by the rule $NP \rightarrow S NP$.

I will present further evidence which supports this convention for automatic reordering in a paper now in preparation, "Gapping and the order of constituents."

8. Some speakers appear to find (4.40a) and sentences like it grammatical, which indicates that for their dialect, the Complex NP Constraint must be modified somehow. I have no idea how to effect a modification of this principle, which otherwise seems to be universally valid, so I can only indicate the existence of this problem now.
9. For an account of such segmentalizational rules, see Postal (1966a).

10. If it should turn out to be possible to treat disjunction as the negation of conjunction, (4.85) will admit of simplification. This problem is discussed in Peters (in preparation).
11. Sentence (4.92b) is perfectly grammatical, and it means 'But she wants to dance, (so) I want to go home.' I have only starred it because it is not related to (4.91).
12. There is evidence, first noted by Chomsky, that a type of adjunction operation is required which produces one of the two structures below, if B is adjoined to A,



depending on whether it is adjoined to the left or right of A. The motivation for the creation of the new node A is as follows: in such a sentence as the boy is erasing the blackboard, it seems clear that the result of adjoining the present participle ending, -ing, to a verb should be a node of some sort. But the stress rules will only work properly if the formative erase is dominated exhaustively by the node V (for a discussion of the stress rules of English, cf. Halle and Chomsky (to appear)). This would indicate that the correct derived structure is

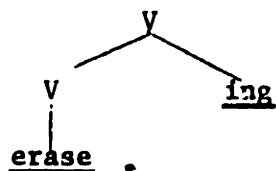

To distinguish this kind of adjunction from what has been called "sister adjunction" (cf. Fraser (1963)), I refer to it as Chomsky-adjunction. It is at present an open question as to whether both types of adjunction need be countenanced within the theory of derived constituent structure. Some consequences of using Chomsky-adjunction in the complement system are explored in Lakoff and Ross (op. cit.), where the proposed analysis of sentence coordination is based in an essential way upon this kind of adjunction.

13. As (4.84) is presently formulated, such a rule would be impossible: no conjunct can be moved. But in § 6.3 below I will show that Lakoff-Peters rule of Conjunct Movement is formally different in one crucial respect from the rules of Relative Clause Formation and Question, and that it is this difference which makes the former possible and the latter two impossible.
14. (4.116a) is acceptable only if strong pauses follow bought and him, i.e., if the second clause of (4.115) has become a parenthetical insert into the first clause and is therefore no longer coordinate with it.
15. This term is Rosenbaum's. Cf. Rosenbaum (1965).

16. Actually, it should be replaced, in (4.130) as well as in (4.126) and (4.128), by a more abstract representation, but this fact has no consequences for my argument.

17. It would probably be possible to order the rules which copy the conjunction and later delete the first of the conjunctions in such a way that at the time at which Relative Clause Formation applied, the NP the boy in (4.133) would still be preceded by and, so the variable would not be null and (4.84) could be invoked to explain the ungrammaticality of (4.134). But such a solution, even if it should prove to be possible for English, which has not been demonstrated, would break down in any language whose relative clauses followed their head noun, as in English, and whose conjunctions followed their conjuncts, as is the case in Japanese. It does not seem unlikely that such a language might exist, so the solution I have proposed in the text is powerful enough to work even for such a language.

18. Of course, (4.136b) is not the correct derived structure for the NP the boy who I saw, because many details of the correct rule of relative clause formation have been omitted in the formulation given in (4.135).

19. I am not sure of the grammaticality of sentences conjoined with and whose conjuncts contain both yes-no questions and WH-questions, e.g.,

? Did you have a good time and what did you bring me?

? What's for supper and is the cat back yet?

I am sure I say such sentences often, but most of them seem somehow disconnected. At any rate, whatever the exact restrictions on them may be, they are not my main concern here.

20. I believe it is possible to restrict convention (4.166) to cases where one noun phrase is contained within another, i.e., that it is not necessary to generalize it so that it applies to all category types. So until additional facts turn up which would force this more general version, I will propose the weaker one of (4.166).

21. The verb habe 'have' has been moved to the end of the relative clauses in (4.179) by a rule which moves verbs to the end of all dependent clauses.

22. Actually, there is some question as to whether the occurrences of the node S which NP₂ and NP₁ dominate in deep structure

will have been pruned by the time the rule of Relative Clause Formation applies. At present, I am not sure that pruning must have already applied. If it has not, the problems under discussion multiply enormously, for then it would presumably be necessary to distinguish between sentences with finite main verbs and those with non-finite main verbs in the revised version of (4.166).

23. I am grateful to Robin Lakoff for suggesting this descriptive and picturesque terminology. Just as the children of Hamelin followed the Pied Piper out of town, so the constituents of larger noun phrases follow the specified noun phrase when it is reordered. This choice of terminology from the realm of fairy tales should not, however, be construed by an overly literal reader as a disclaimer on my part of the psychological reality of (4.180).
24. There are certain nomenclative Feinschmeckers who have taken issue with the formulation of this sentence, pointing out that following the original Pied Piper was obligatory for all the children of the town except one, who was lame, so that the phrase "obligatory pied piping" is a case of terminological coals to Newcastle. These critics suggest that since convention (4.180) describes optional accompaniment, such accompaniment
-

should best be dubbed "fellow traveling," or the like, with the term "pied piping" being reserved for cases of mandatory accompaniment, such as those described below.

While the point they make is valid, I have chosen to disregard it, eschewing an exact parallel to the fairy tale in question in the interests of a less elaborate set of terms.

25. The fact that NP_1 does not dominate S, and that (4.188a) is still grammatical, simply indicates that (3.26) is formulated incorrectly, and that Condition 1 on that rule must be revised. It is abandoned entirely in (5.57), the final statement of this rule.
26. I have starred (4.190a) because it is unrelated to (4.190b) -- the how in (4.190a) does not replace to what extent, but rather something like in what respect or in what way. Note also that the echo-questions for these two sentences differ: (4.190a) is related to Peter is sane HOW? but (4.190b) to Peter is HOW sane? Similarly, although (4.191a) is grammatical, it is not related to (4.191b).
27. Note that place is ambiguous: it can mean 'residence, dwelling', and in this sense, the preposition can be left behind (Whose place do you live at?).

28. This problem is discussed at some length in Keyser (1967).
29. It may be that (4.237) is not grammatical unless Conjunction Reduction applies again to reduce the parenthesized are, but I will disregard this problem here.
30. Later rules will convert (4.242b) into the boy's uncle and aunt's grandmother.
31. There is, however, an additional restriction which pertains to structures like (4.253): while it is possible to move the boxed NP, it is not possible to move the circled one -- the string *Which cars were the hoods of damaged by the explosion? is ungrammatical. It is not in general the case that the preposition of in the NP the hoods of the cars cannot be stranded (witness the grammaticality of Which cars did the explosion damage the hoods of?) so another clause must be added to condition (4.206), making pied piping in the environment $[P \text{ ___}]_{NP}$ also obligatory where the prepositional phrase is dominated by an NP which is immediately dominated by S. In passing, it should be noted that the statement of this condition will require quantifiers or some equivalent notation, such as node subscripts. This means that the formal apparatus which

is available for stating conditions in a conditions box must be stronger than that available for stating conditions on particular rules.

32. Cf. Lees (1960), pp. 65-67. I will follow his terminology in calling the nominalization in (4.261a) the action nominal, and I will refer to the nominalization in (4.261b) as the factive gerund nominal.

33. For a fuller discussion of the conditions under which "backward", or right-to-left, pronominalization is possible, as well as some remarks about the notion of subordinate clause, cf. Ross (1967a), and § 5.3 below.

Chapter 5

BOUNDING, COMMAND, AND PRONOMINALIZATION

5.0. In the summer of 1966, Ronald Langacker and I, working independently on the same general problem, arrived at highly similar solutions. The problem was that of restricting variables which appeared in the structural descriptions of various rules in such a way that the notion of sentence under consideration could be captured. To this end, I proposed a formal device I called bounding (cf. Ross (1966b)), which will be explained in § 5.1 below. Langacker's notion of command, which he introduces and discusses at length in his important paper, "Pronominalization and the chain of command" (Langacker (1966)), seemed to me until recently to be as nearly adequate to this end as bounding -- while there were some facts which could be handled with command but not with bounding, there were also facts for which the opposite was the case. Recently, however, I have come to the realization that the latter type of facts, which I took to be an indication of the necessity of including the notion of bounding in linguistic theory, can in fact be handled with command, by extending its definition in a natural way. Langacker's notion is thus clearly preferable, and it, not the notion of bounding, should be a part of the theory of language.

In § 5.1, I will explain the notion of bounding and

discuss the kinds of facts which it is meant to account for. In § 5.2 I will show how all these facts can be accounted for with command, and give several facts that cannot be handled with bounding. In addition, I will point out one way in which bounding is too strong. In § 5.3 I will discuss pronominalization briefly in this context, and show that the major condition on the rule of Pronominalization, that it only go backward into subordinate clauses, should really be construed as a condition on all deletion transformations of a specified formal type.

5.1. Bounding

5.1.1.

5.1.1.1. Let us reconsider the rule of Extrapolation, (4.126). How is this rule to be ordered? If the cyclic theory of rule application proposed by Chomsky (cf. Chomsky (1965)) is correct¹, then the rule of It-Replacement must be a cyclic rule, as Lakoff has demonstrated (cf. Lakoff (1966)). This rule converts (5.1) into (5.2), and (5.3) into (5.4) by substituting the subject of the embedded sentence for the pronoun it and daughter-adjoining the remainder of the embedded sentence to the VP of the matrix sentence.

(5.1)

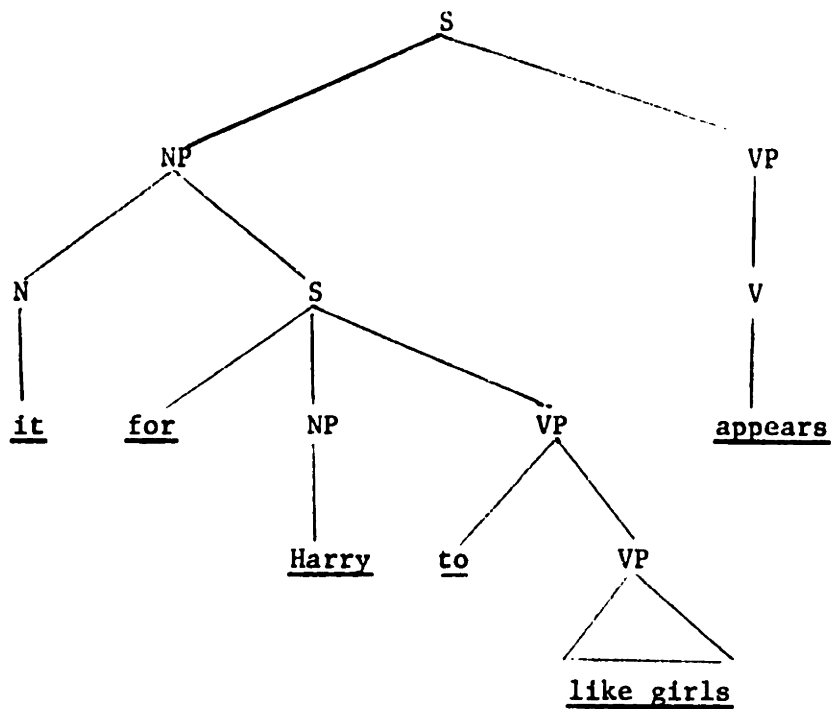

(5.2)

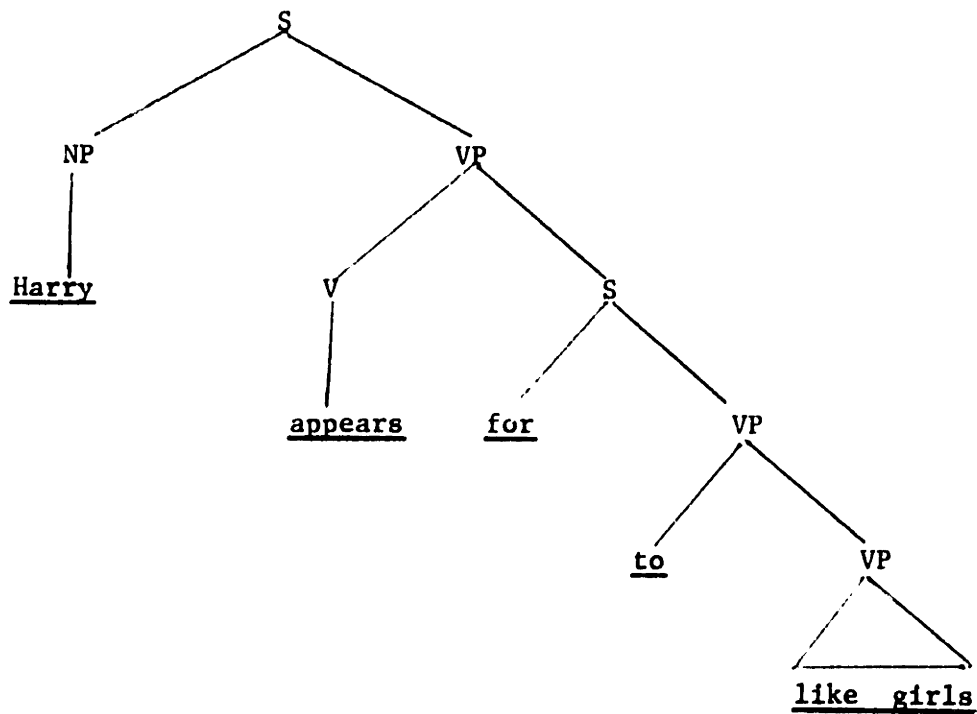

(5.3)

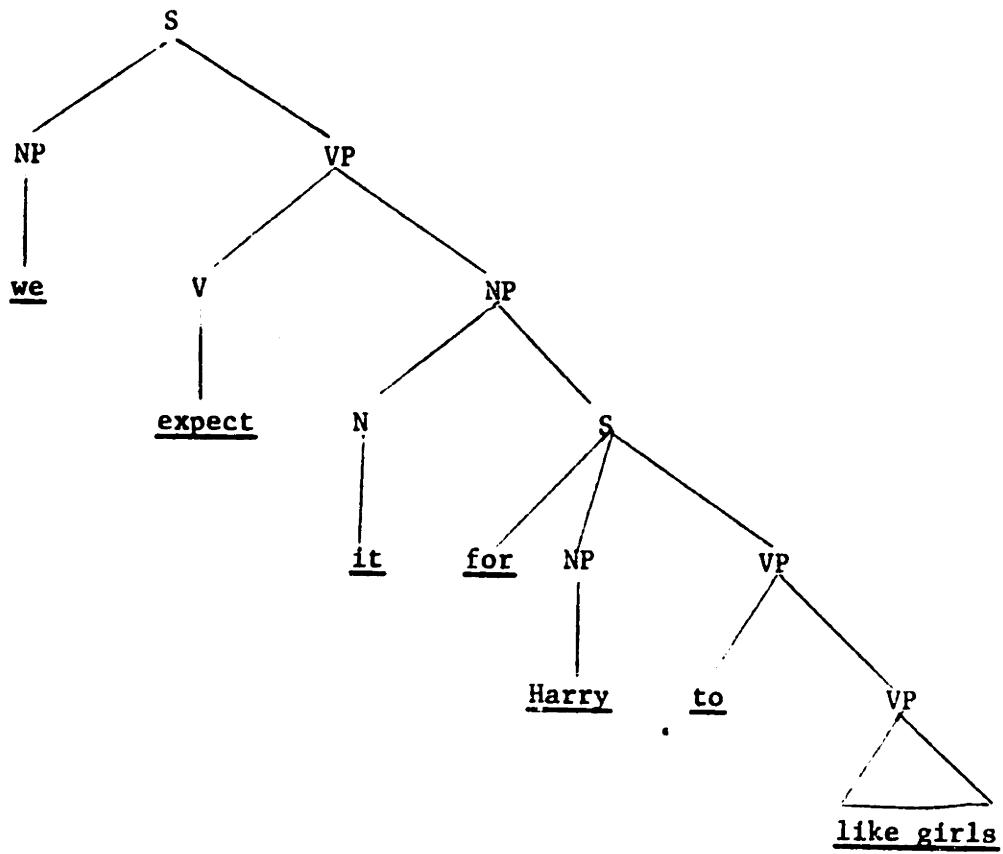

(5.4)

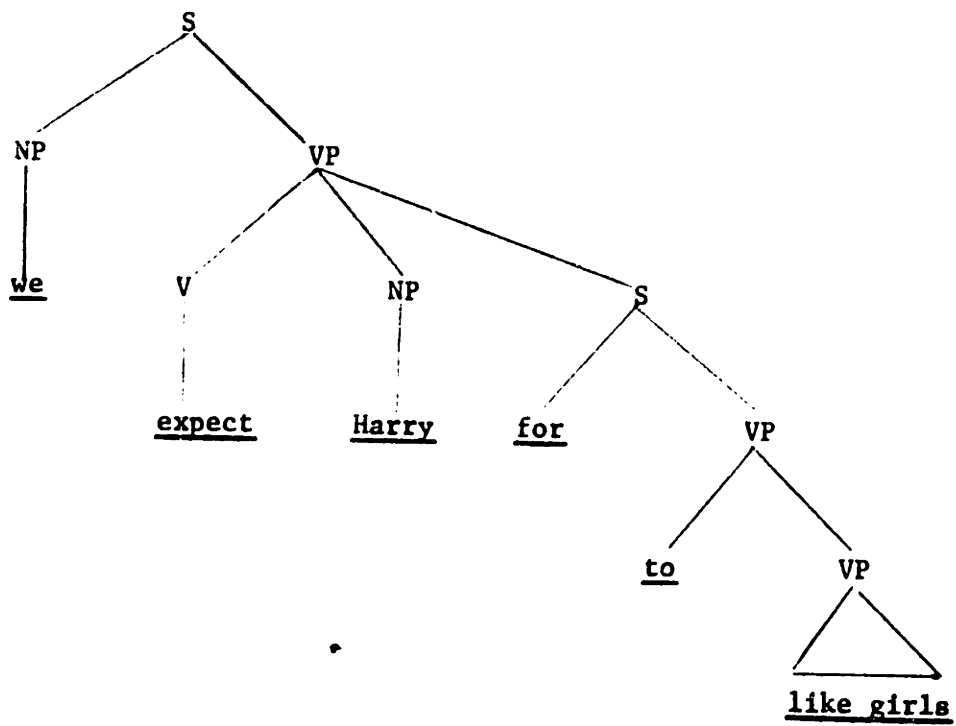

I will attempt to show that if It Replacement is in the cycle, Extrapolation cannot be, for it would produce an intuitively incorrect derived constituent structure for sentences like (5.5).

(5.5) It appears to be true that Harry likes girls.

To me, it seems clear that there is a large constituent break after true. A plausible derived structure for this sentence is the one shown in (5.6)

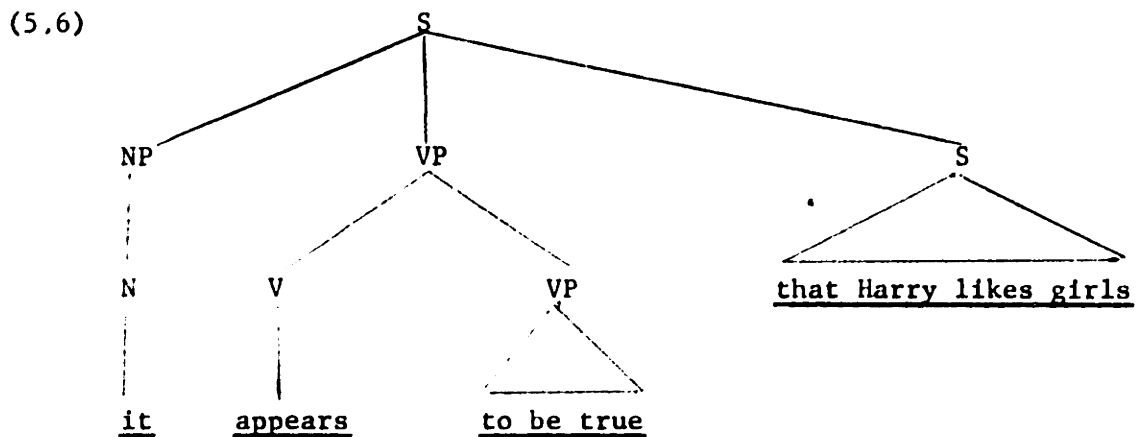

If Extrapolation is a cyclic rule, it will first apply to (5.7), which underlies (5.5), on the S_2 cycle, yielding (5.8) as an output.

(5.7)

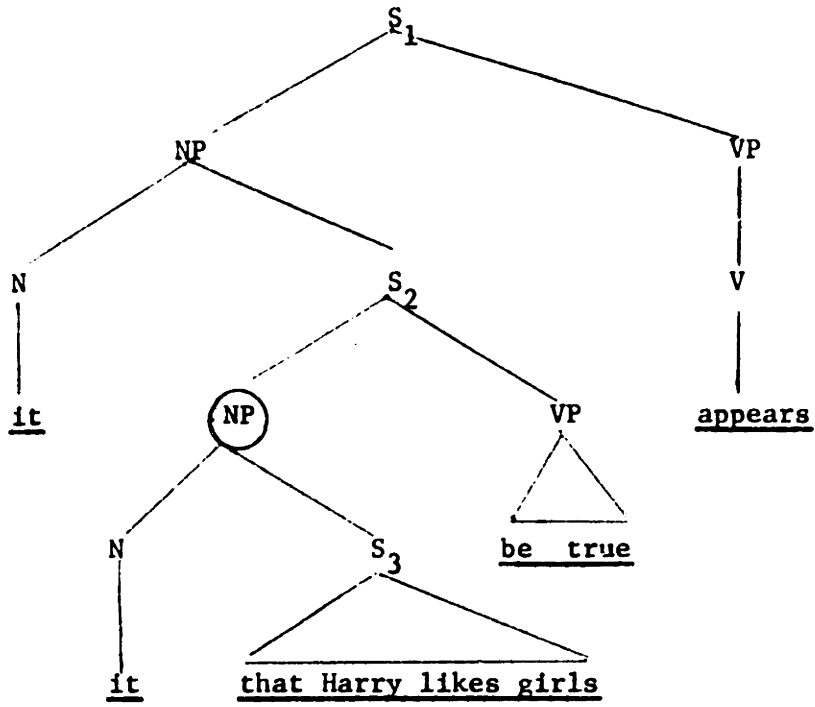

(5.8)

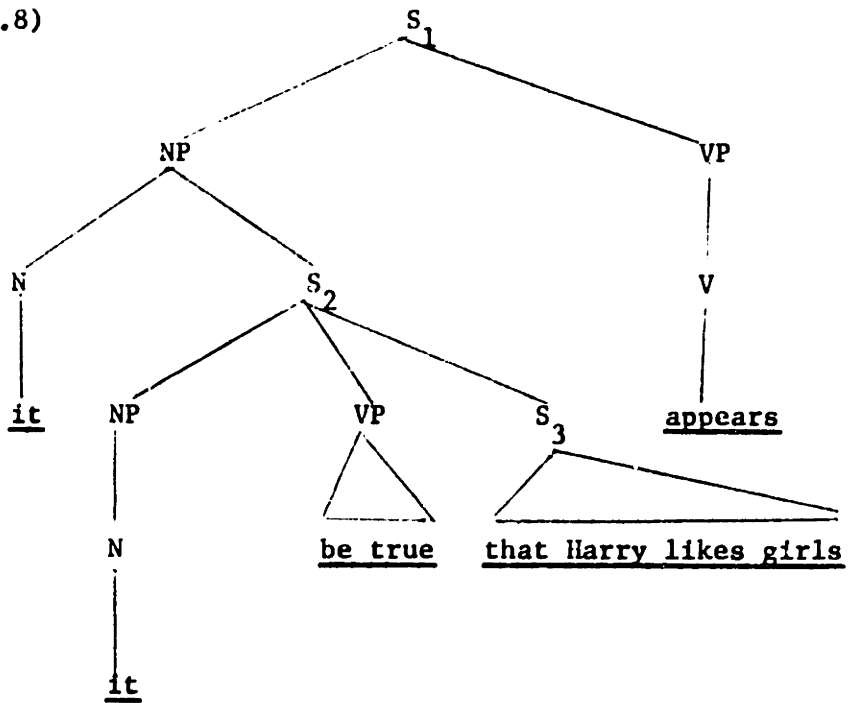

Now, on the S_1 cycle, after the complementizers for and to have been introduced, application of the rule of It-Replacement will yield (5.9) as an intermediate structure underlying (5.5). The complementizer for is deleted by a later rule.

(5.9)

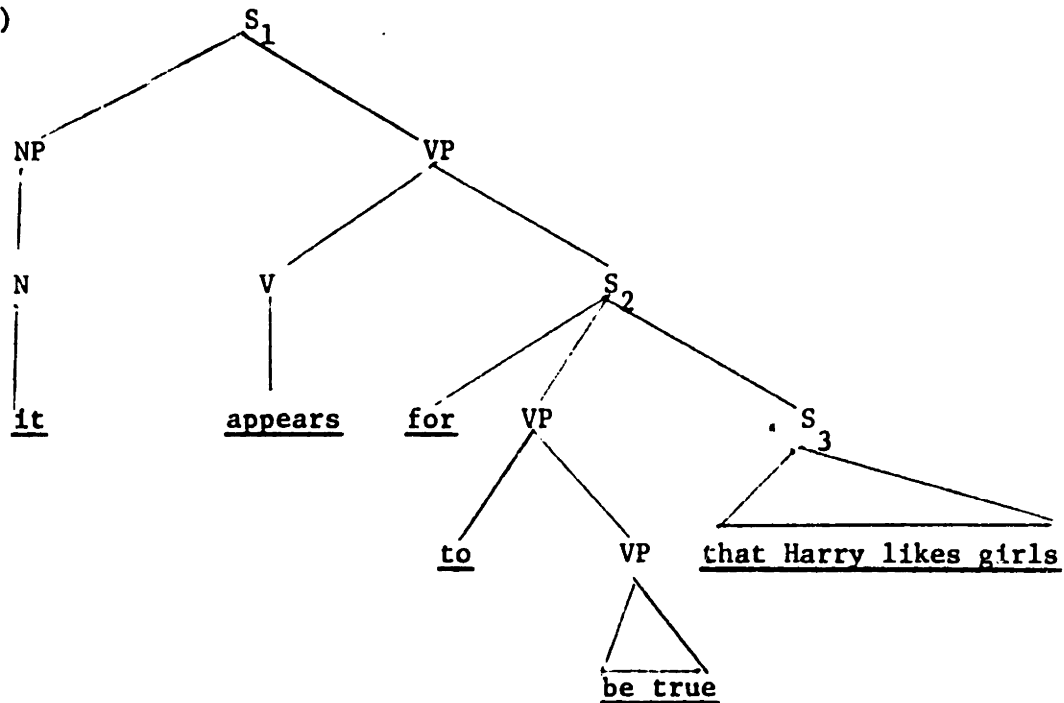

But (5.9) seems highly inadequate as a representation of the intuitive structure of (5.5), for it not only makes the claim that the strings to be true that Harry likes girls and appears to be true that Harry likes girls are constituents, but it also makes the claim that appears to be true is not a constituent. All of these claims strike me as being the exact opposites of the truth about the constituent structure of (5.5), which is captured correctly in (5.6).

The structure shown in (5.6) can be derived from deep structure (5.7) if Extrapolation is a last-cyclic rule.² In this case, no rules of importance here would apply until S_1 . On this cycle, after complementizer placement, the circled NP in (5.7) would become the derived subject of S_1 by It-Replacement, yielding the intermediate structure (5.10):

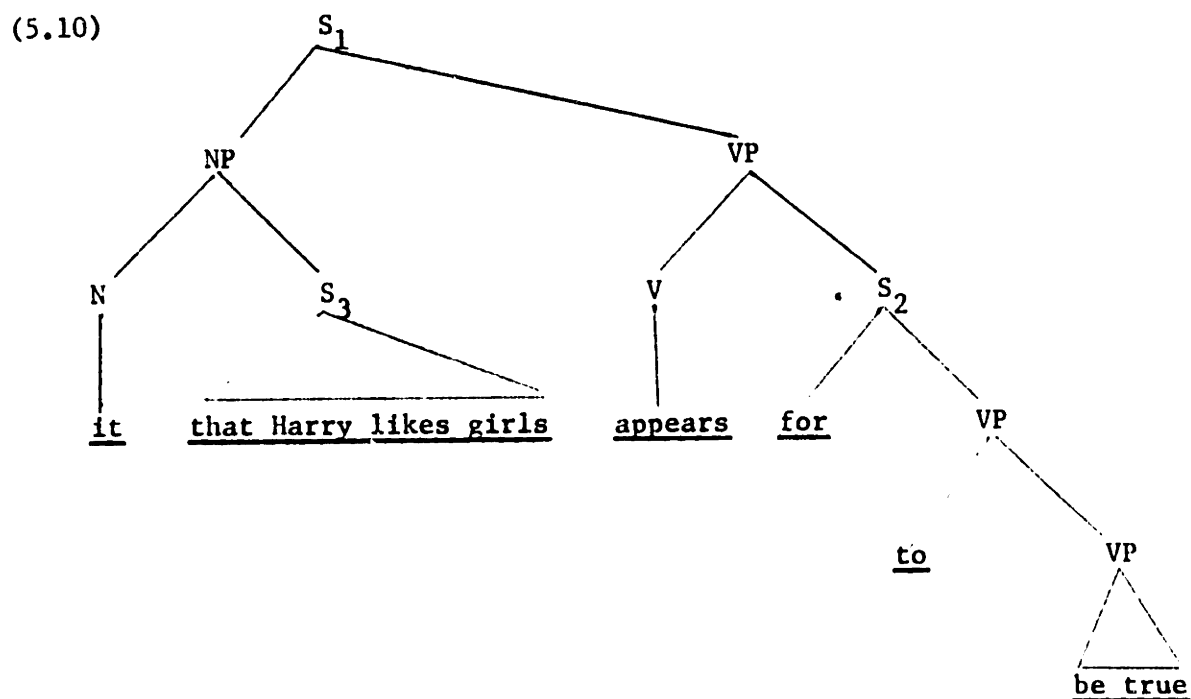

When Extrapolation is applied to (5.10), the correct (5.6) results.

The above facts can be accounted for if Extrapolation is made a last-cyclic rule, but this is not the only means of arriving at the correct derived structure for sentences like (5.5). Noam Chomsky has suggested to me in conversation that it seems necessary to add

certain phonologically motivated rules of adjustment to the grammar of English, to account for the intonation of such right-branching sentences as (5.11),

(5.11) This is the dog that chased the cat that caught the rat that ate the cheese.

to which normal transformations would assign some structure like that schematically represented in (5.12).

(5.12)

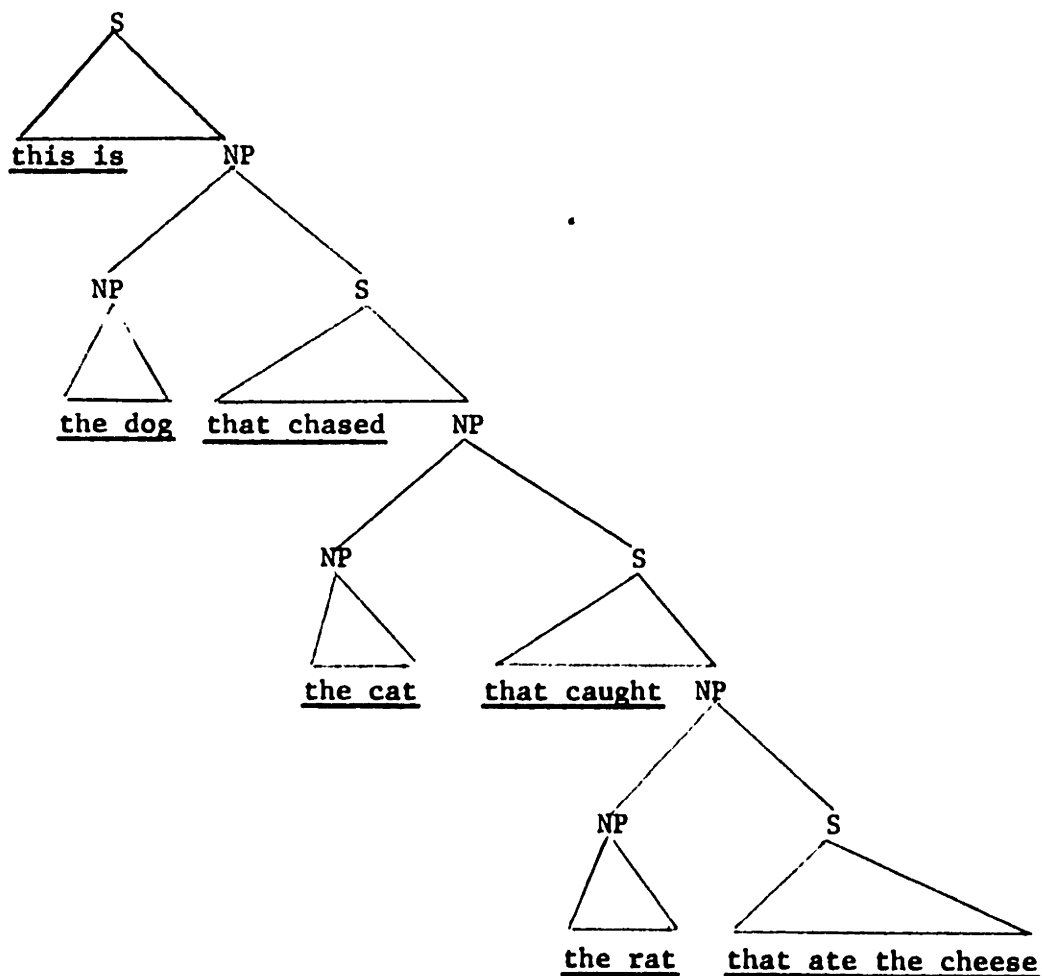

On the hypothesis that intonation rules should correlate length of pause with size of constituent break³, (5.11) would not be assigned its observed intonation pattern, where pauses of roughly equal size precede each occurrence of that, unless some rule were to operate on the nested syntactic output structure of (5.12) to turn it into the roughly coordinate phonological input structure which the normal pause pattern of (5.11) would indicate. Such rules Chomsky proposes to call "surface structure adjustment rules", and he suggests that the same rule which raises the nested sentences of (5.12) to make them coordinate with the highest sentence there might be formulable in such a way that it would also raise S_3 to the level of S_1 in (5.9), thus producing (5.6), the correct derived structure of (5.5), from (5.7), even if the rule of Extrapolation is made a cyclic rule.

Until some detailed work has been done on the problem of such adjustment rules, it is not possible to accept or reject this proposal conclusively. However, even if Chomsky's proposal should prove to be correct, there is another argument, independent of this one, which indicates that Extrapolation cannot be a cyclic rule.

Consider such intercalated structures as (5.13).

(5.13) Ivan figured it out that the bridge would hold.

This sentence derives from the structure shown in (5.14).

(5.14)

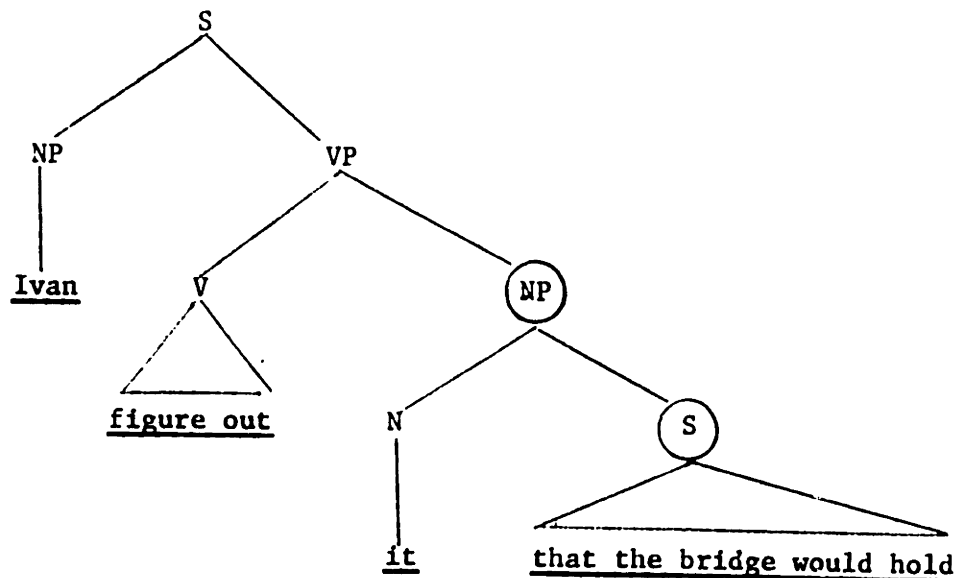

To this structure, the two rules of Particle Movement, (3.9), and Extrapolation apply. From the arguments given above, in § 4.2.4.2, it follows that Particle Movement must apply first, moving the particle out to the right of the circled NP of (5.14); for Extrapolation cannot apply "vacuously" to attach the circled node S somewhere higher up the tree, if sentences like the ungrammatical (4.132b) are to be avoided.

However, if we assume Extrapolation to be cyclic, since Particle Movement precedes it, it must also be cyclic. But if Particle Movement is cyclic, then the problem arises as to how sentences containing ungrammatical action nominalizations like the one in (5.15a) are to be excluded.

- (5.15) a. * Her efficient looking of the answer up
pleased the boss.

- b. Her efficient looking up of the answer
pleased the boss.

Sentence (5.15b) demonstrates that the ungrammaticality of (5.15a) does not reside in an incompatibility between verb-particle constructions and action nominalizations in general, and that it can only be attributed to the fact that Particle Movement has applied when the sentence in the underlying subject of (5.15a) was processed, but not when the one in the subject of (5.15b) was. I believe the claim to be warranted that action nominalizations are derived from embedded sentences -- that is, that there are two passes made through the transformational cycle in processing (5.15b) -- and not, as Chomsky suggested in course lectures in the spring of 1966, by means of lexical derivation rules; but I cannot go into this problem here. I mention the matter merely because (5.15a) could rather easily be excluded if the subject NP of (5.15b) had been produced in the lexicon: if the word looking in (5.15) is best considered to be a derived noun, which seems to me to be an open question, then Particle Movement could not apply to it, and even if looking must be considered to be a verb, (3.9) could be made to block because of the presence of an intervening of. But if action nominalizations are desentential, as I believe to be the case, no such easy explanation is available. It would of course be impossible to impose the condition upon (3.9) that it not operate in any sentence which was embedded in whatever the correct underlying structure for

action nominalizations turns out to be, for by the principle of operation of the transformational cycle (cf. Chomsky (1965), p. 134-135), contexts from higher sentences than the one being processed cannot be referred to in cyclic rules. This would mean, then, that Particle Movement would have to be allowed to apply freely, and that some ad hoc condition would have to be imposed upon Action Nominalization so that it would block in case Particle Movement had applied on the previous cycle. This is not impossible, merely laboured, inelegant and undesirable.

The obvious way out of this latter difficulty is to make Particle Movement a last-cyclic rule, and to order it after the rule which forces action nominalizations. If this rule has applied, Particle Movement will be blocked by a constraint which is necessary in any case: particles cannot be moved over an object NP which starts with a preposition. Thus the particle away may not be moved over the NP with her father in (5.16a).

(5.16) a. She did away with her father.

b. * She did with her father away.

It is necessary to claim that idioms like do away with, sit in on, etc., which were mentioned in § 4.3.2.2 above, consist of a verb-particle combination followed by a prepositional phrase, and not simply of a verb followed by two prepositions and a noun phrase, for it is the case that only that subclass of prepositions which can function as particles (e.g. along, by, on, in, off, up, etc., as opposed to at, among, for, etc.) can occur as the first member of such a two-preposition chain.

5.1.1.2. Thus if Particle Movement is last-cyclic, (5.15a) will be excluded without any additional complication of the rules of Action Nominalization or Particle Movement. But what about the rule of Extrapolation? Since it follows Particle Movement, it is last-cyclic: what then will prevent it applying to (5.17) to produce the ungrammatical (5.18)?

(5.17)

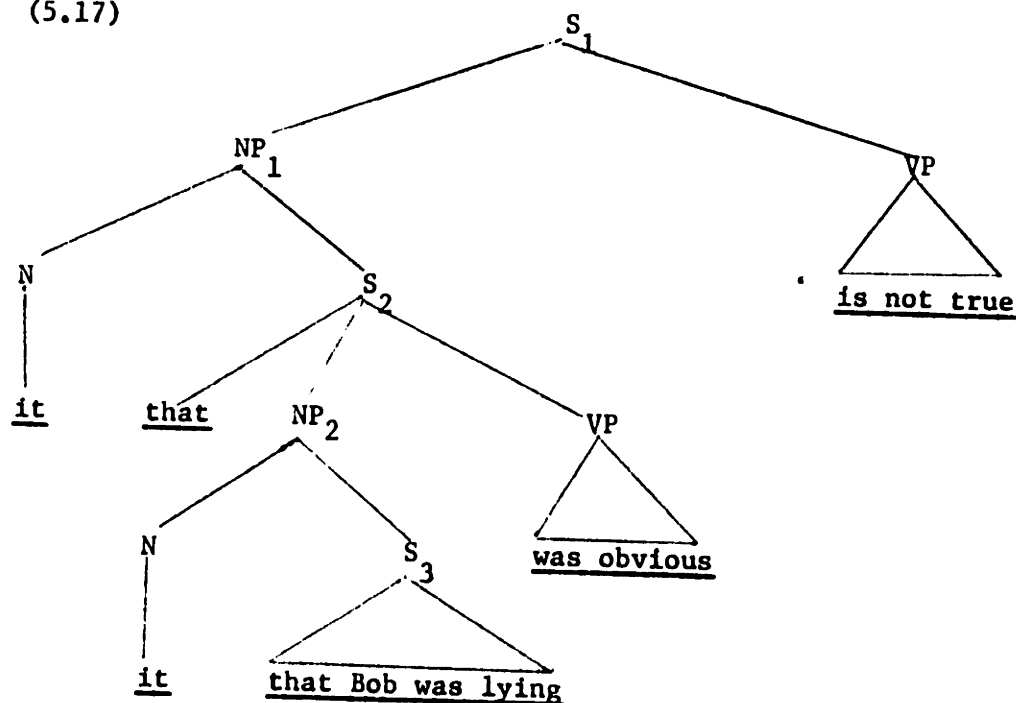

(5.18) * That it was obvious is not true that Bob was lying.

For since there are variables in the structural index of Extrapolation, when it applies on the last cycle, it can either operate to move S_2 out of NP_1 , in which case, the grammatical (5.19) will result,

(5.19) It is not true that that Bob was lying was
obvious.

or it can operate to move S_3 out of NP_2 , yielding the ungrammatical (5.18).

This problem is highly reminiscent of the one discussed in Case C of § 2.2, which was given as supporting evidence for the A-over-A principle. But since the facts given in § 2.1 show the principle to be too strong, I have tried to find alternative explanations for all the cases given in support of it in § 2.2. Cases A and B have been accounted for by the Complex NP Constraint, Cases D and E by the Left Branch Condition on pied piping (4.181), and Case F has been shown to be a special case of the Coordinate Structure Constraint. Only Case C remains.

The problem discussed in Case C was how the rule of Extrapolation from NP should be constrained so that it will apply to (2.7) to produce (2.8), but not (2.9), all of which I reproduce here for convenience.

(2.7)

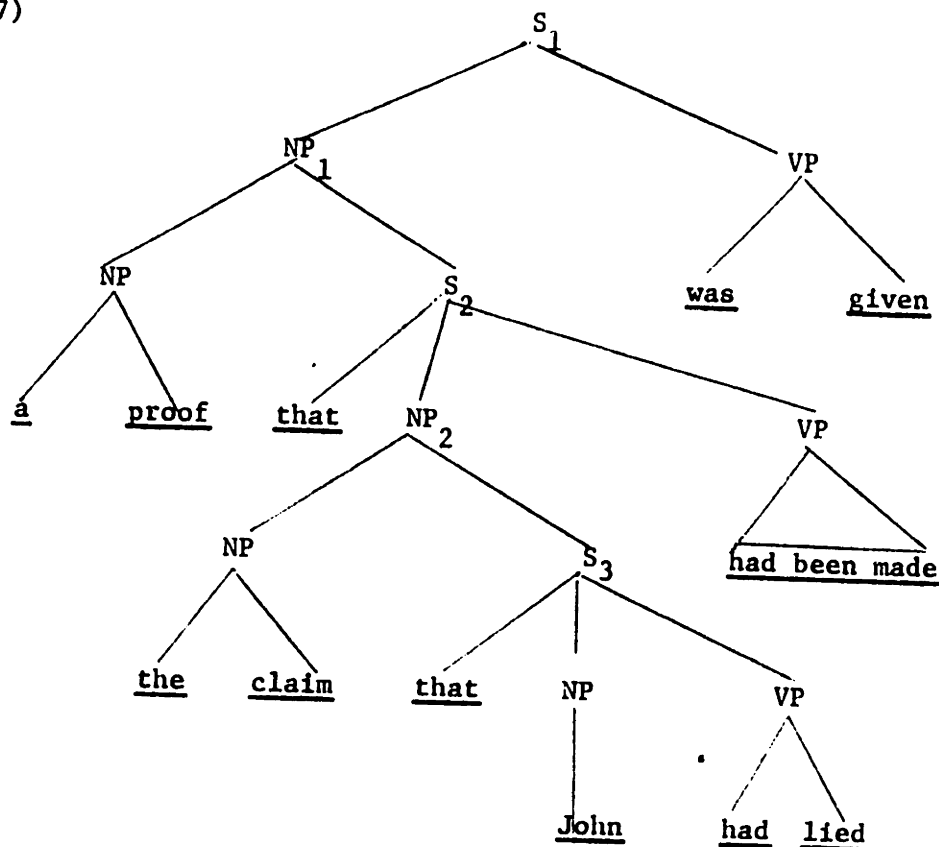

(2.8) A proof was given that the claim that John had lied had been made.

(2.9) * A proof that the claim had been made was given that John had lied.

Just as was the case with (5.18), (2.9) results from S_3 being extraposed "too far". It happens that (2.9) can be blocked with machinery that is already available, but this is not true of (5.18). For notice that NP_1 in (2.7) is complex, and that the Complex NP Constraint will therefore not allow S_3 to be moved out of S_2 . But what will stop S_3 from being extraposed out of S_2 in (5.17)? It

is not the case that constituents of clauses dominated by noun phrases whose head noun is the pronoun it cannot be moved out of these clauses, as the grammaticality of (4.13a) shows. And even supposing that it were possible to formulate some revised version of the A-over-A principle which was strong enough to exclude (5.18), but weak enough to avoid the counterevidence in § 2.1, the problem would remain. For consider structure (5.20)⁴:

(5.20)

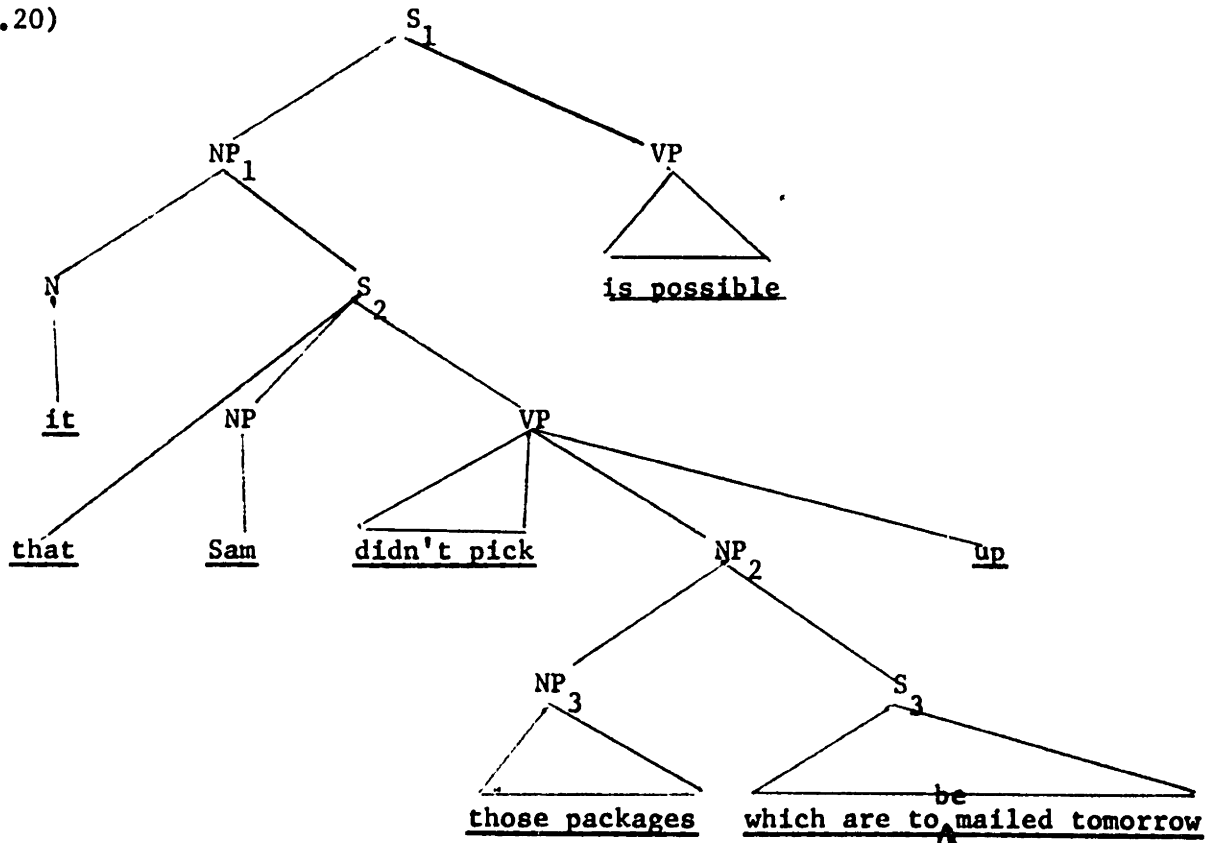

Since the rule of Particle Movement must be last-cyclic, for the reasons discussed above in connection with (5.15), it is obvious that Extrapolation from NP must also be; for it, like Extrapolation, must follow Particle Movement. But now the question is, how will Extrapolation from NP apply to (5.20)? As this rule is presently formulated, the variables in it will allow the extrapolation of S_3 to the end of S_1 , with (5.21) as the ungrammatical result.

(5.21) * That Sam didn't pick those packages up is possible which are to be mailed tomorrow.

How can this sentence be blocked? Even if it were assumed that the two rules of extrapolation were the same, and could be collapsed into one (I will show why such an assumption would be incorrect immediately below), the A-over-A principle could not be invoked to block (5.21). For this principle dictates that transformational rules must apply to a tree uniquely, and always in the highest possible environment. Since both NP_1 and NP_2 would meet the structural index for a collapsed rule of Extrapolation, the A-over-A principle would predict that this Extrapolation could only affect the higher NP, NP_1 , moving S_2 to the right of is possible⁵. But in fact, either clause can be extrapolated to the end of "the first sentence up", independently of whether the other has been. Thus if neither has been, (5.22a) results; if only S_2 has been, (5.22b) results; if only S_3 has been, (5.22c) results; and if both have been, (5.22d) results.

- (5.22) a.?* That Sam didn't pick those packages which
are to be mailed tomorrow up is possible.⁶
- b. * It is possible that Sam didn't pick those
packages which are to be mailed tomorrow up.
- c. That Sam didn't pick those packages up which
are to be mailed tomorrow is possible.
- d. It is possible that Sam didn't pick those
packages up which are to be mailed tomorrow.

Thus, since S_3 must be allowed to extrapose, so that (5.22c) and (5.22d) can be generated, it seems to me inconceivable that any version of anything resembling the A-over-A principle can be devised which could exclude (5.21).

5.1.1.3. A final nail in the coffin of any such proposal is provided by the following argument, which shows the two rules of extraposition to be necessarily distinct, because another rule, Question, must intervene between them. That is, the rules must be ordered as in (5.23).

- (5.23) 1. Particle Movement (3.9)
2. Extraposition (4.126)
3. Question (4.1)
4. Extraposition from NP(1.10)

The necessity for this ordering can be seen in connection with (5.24), which derives from the intermediate structure (5.25), a structure only minimally different from (5.20).

(5.24) Which packages is it possible that Sam didn't
pick up which are to be mailed tomorrow?

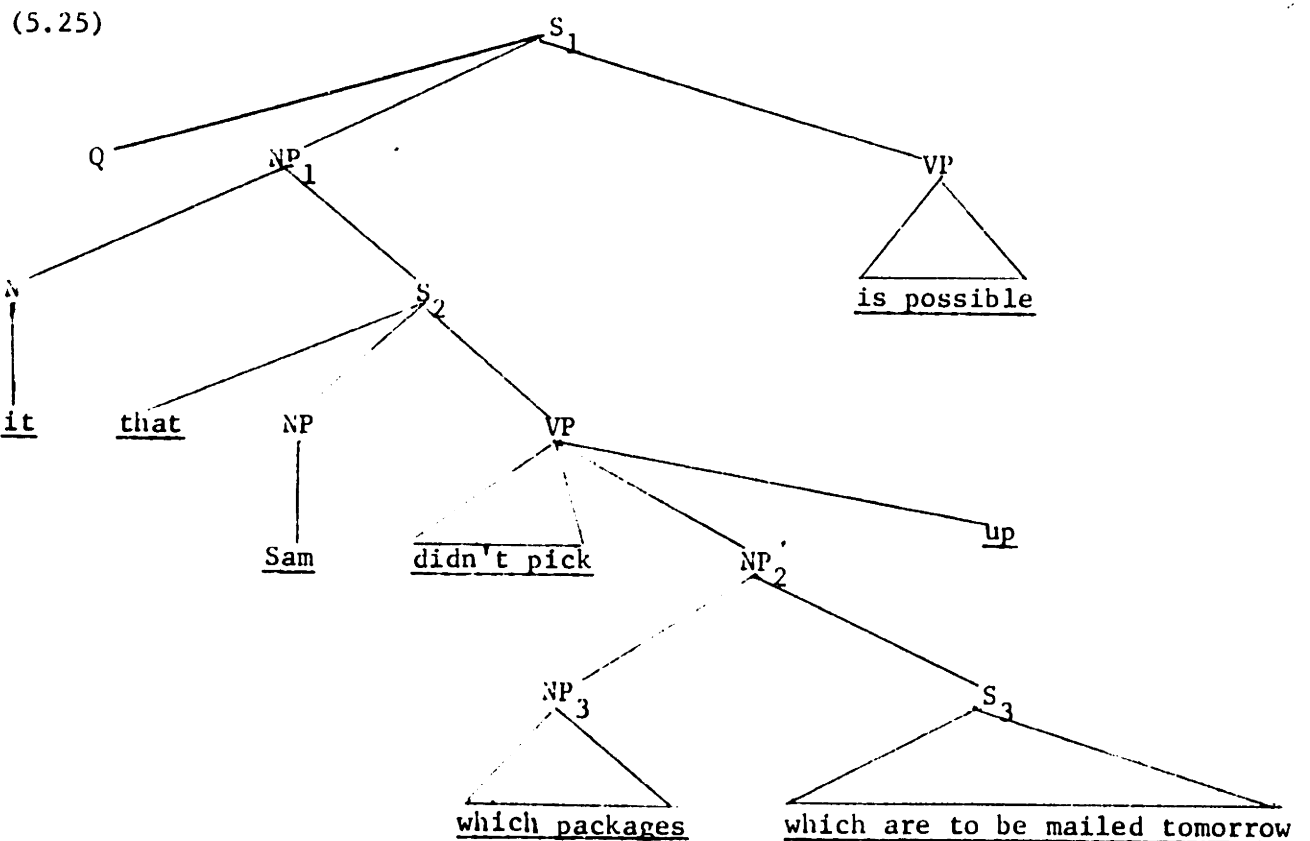

It should be obvious that Extrapolation must precede Question, for if S_2 has not been moved out of NP_1 to the end of S_1 , the questioned element, NP_3 will be contained in a sentential subject, NP_1 , and will be prohibited from moving out of it by the constraint stated in (4.254). But it is not so obvious that Extrapolation from NP must follow Question.

For if it is assumed that (5.21) can somehow be avoided, it might be argued that a collapsed rule of extraposition could operate to move both embedded sentences to the ends of the appropriate higher sentences, yielding a structure like (5.26)⁷

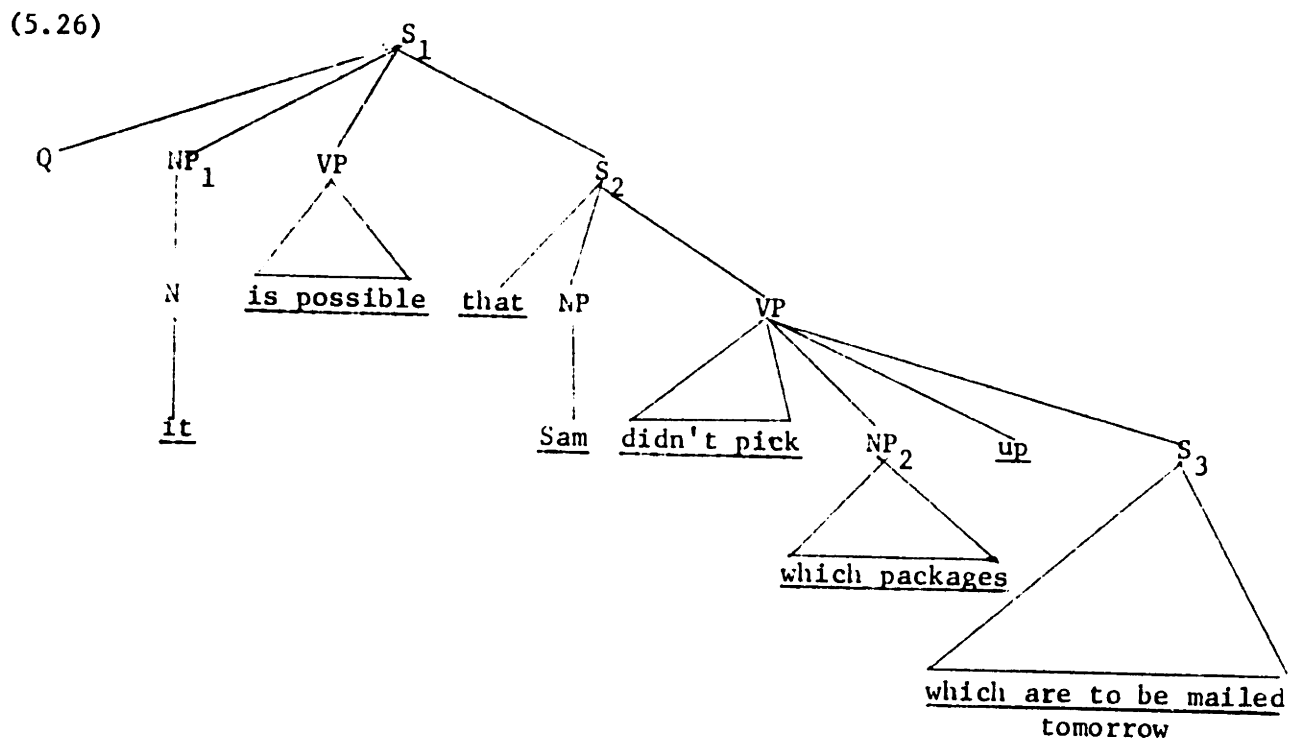

But notice that if the questioned NP, NP₂, is now moved to the front of S₁ by the rule of Question, and the subject and copula are inverted, the resulting structure is (5.27), not the intuitively correct (5.28).⁸

(5.27)

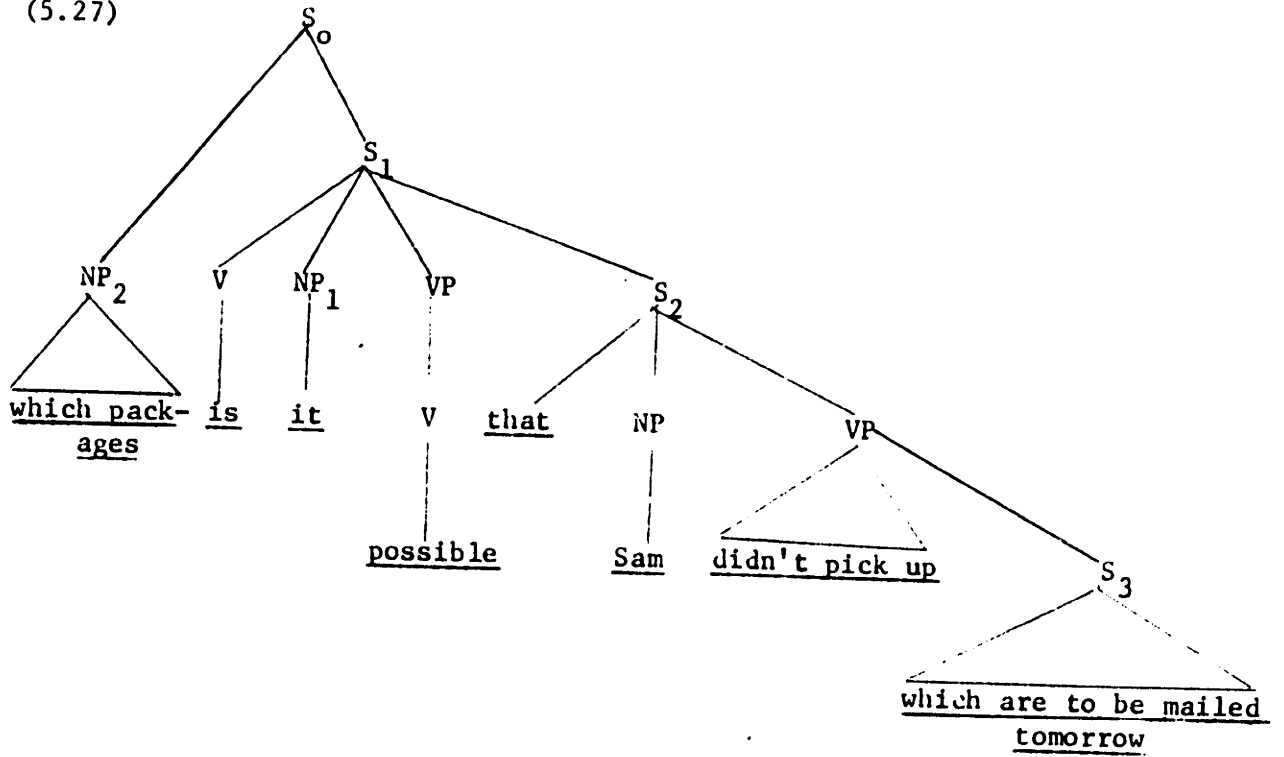

(5.28)

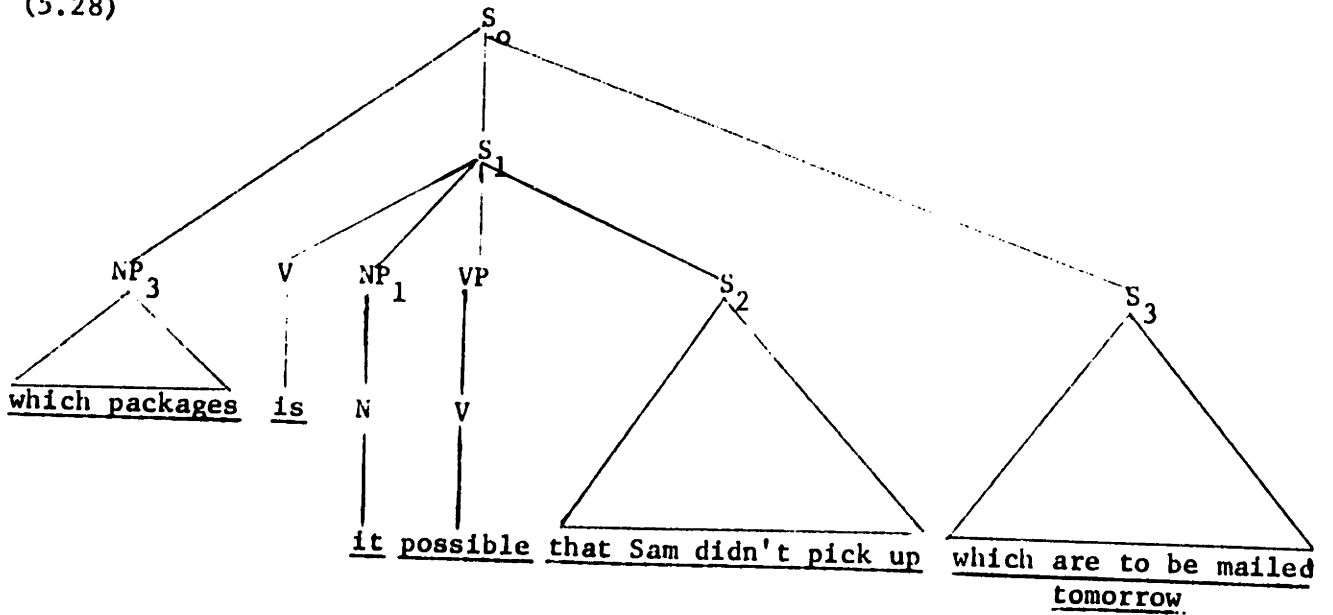

The structure shown in (5.27) makes the incorrect claim that the string didn't pick up which are to be mailed tomorrow is a constituent, while (5.28) correctly reflects the fact that there is a large constituent break after the particle up. It might appear that the same method of avoiding this undesirable result that Chomsky has proposed for avoiding the similar intuitive inadequacy of (5.9), namely having some surface structure adjustment rule obligatorily convert (5.27) to (5.28), just as (5.9) would be converted to (5.7), could be made use of in this case.

To see that this is impossible, consider (5.29) and an intermediate structure underlying it, (5.30):

(5.29) Sam didn't pick those packages up which are to be mailed tomorrow until it had stopped raining.

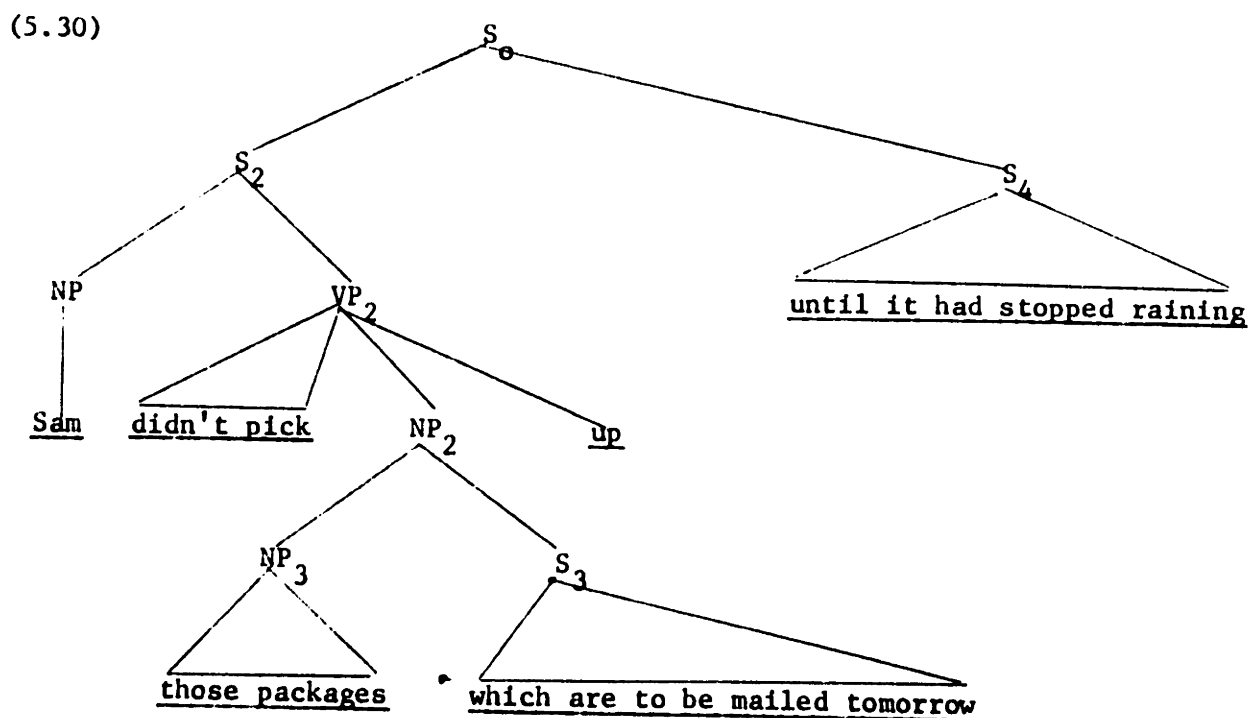

How does the rule of Extrapolation from NP apply to (5.30)? If some constraint can be stated on this rule which has the effect of only allowing the extraposed clause to move to the end of the first sentence up, then the rule could apply to (5.30) to produce the derived structure (5.31).

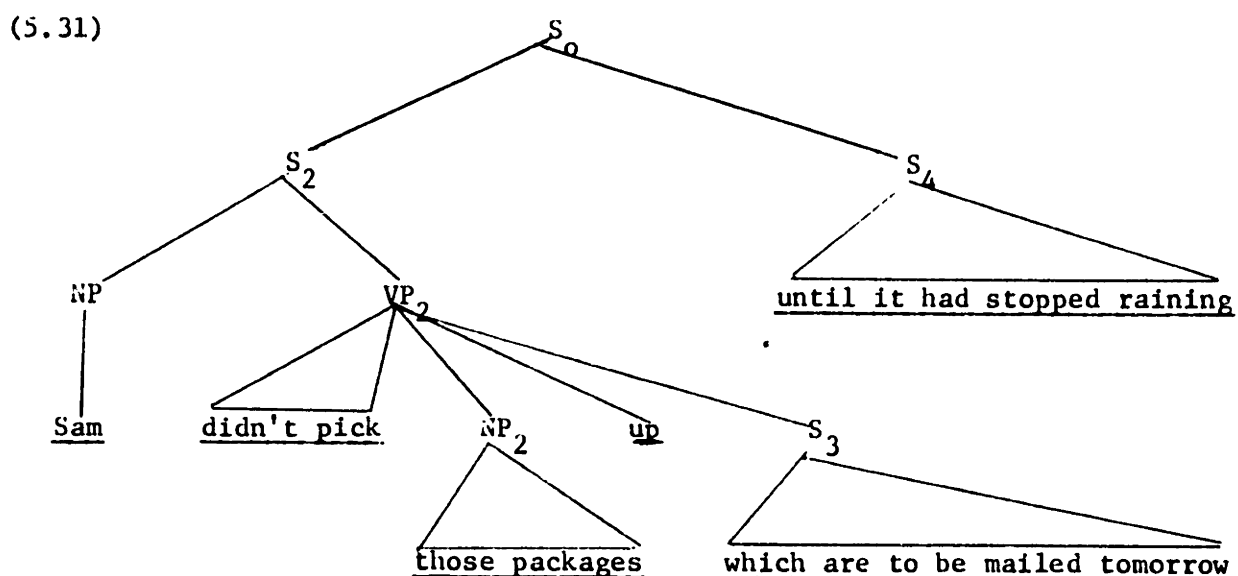

Since some such constraint will be necessary in any case, so that (5.21) can be avoided, the grammaticality of (5.29), where the extraposed relative clause immediately follows the particle up, provides some support for the structure shown in (5.30), in which S_4 is not a constituent of S_2 . The facts of do so pronominalization (cf. Lakoff and Koss (1966)) indicate that S_4 could not be dominated by VP_2 , for do so stands for a whole VP, and until-clauses are outside the VP, as is shown by the grammaticality of (5.32).

(5.32) Sam picked those packages up which are to be mailed tomorrow last night, but he didn't want to do so until it had stopped raining.

If S_4 were directly dominated by S_2 in (5.30), then we would expect that the most normal version of this sentence would be (5.33), not (5.29).

(5.33)?* Sam didn't pick those packages up until it had stopped raining which are to be mailed tomorrow.

In my speech, (5.33) is impossible unless heavy intonation breaks surround the until-clause, in which case it is fairly acceptable. But such a sentence should clearly be analyzed as a stylistic variant derived from (5.29) by the optional rule which positions adverbs in various positions between major constituents of a sentence,⁹ not as the most normal form for this sentence.

But now notice what happens if a structure like that shown in (5.30), except that which replaces those, is embedded in place of S_2 in (5.25). Two variants of the resulting structure, (5.34), are possible: (5.35a), in which the relative clause S_3 has not been extraposed away from its head NP, which packages, and (5.35b), in which it has.

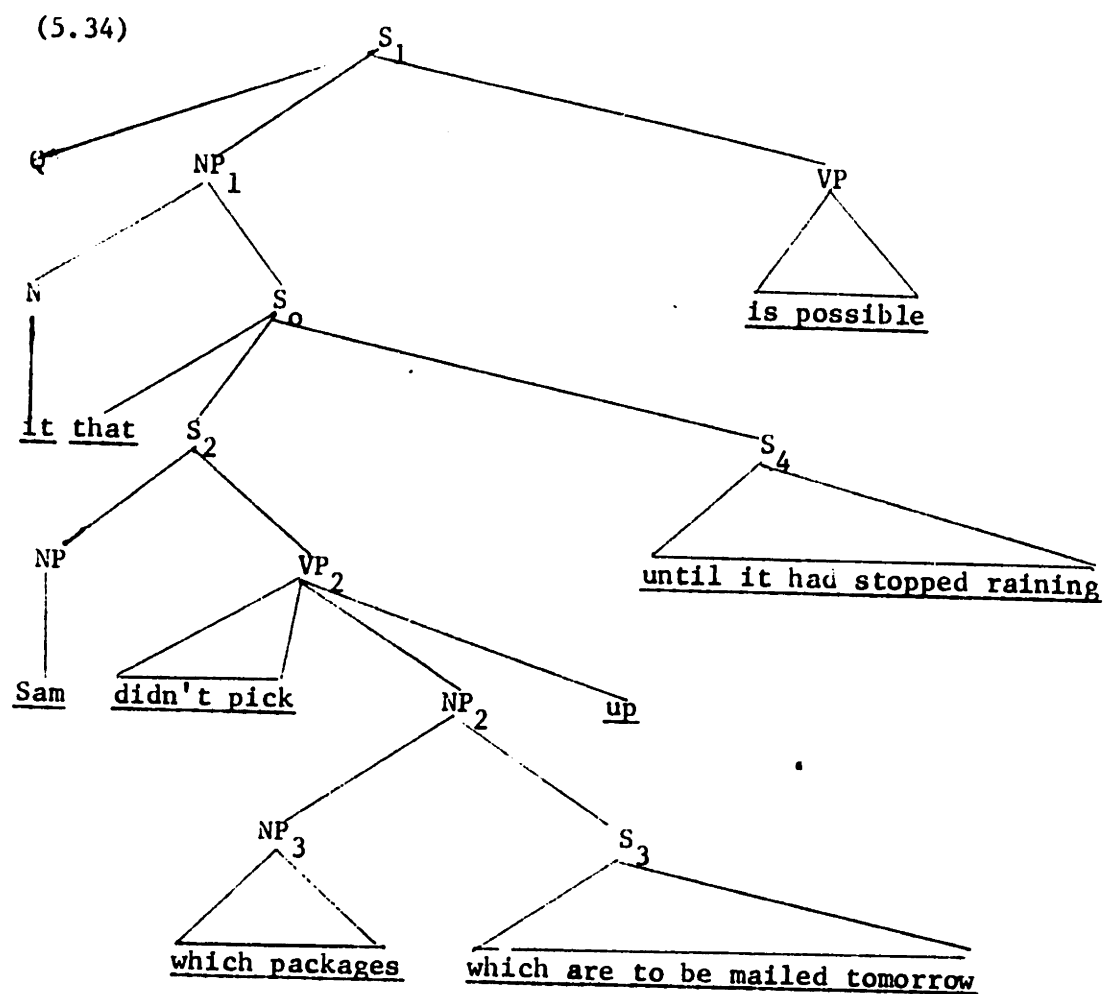

(5.35) a. Which packages which are to be mailed tomorrow is it possible that Sam didn't pick up until it had stopped raining?

b.?? Which packages is it possible that Sam didn't pick up until it had stopped raining which are to be mailed tomorrow?

While it is clear that (5.35a) is the more comfortable version of the two, by far, I think (5.35b) should be treated as being

grammatical but of low acceptability. For notice that the acceptability of (5.35b) can be improved by lengthening the extraposed relative clause, as in (5.36).

- (5.36) Which packages is it possible that Sam didn't pick up until it had stopped raining which he had arranged with his agents in Calcutta to send to him here in Poplar Bluff because of his fear that someone in Saint Louis might recognize him?

Note that in (5.35b) the extraposed clause follows the until-clause, which the ungrammaticality of (5.33) shows not to be possible when the structure underlying (5.29) is not embedded. But more important is the fact that the preferred order in the non-embedded case, i.e., with the relative clause preceding the until-clause, as in (5.29), is absolutely impossible in the embedded case, as the ungrammaticality of (5.37) shows.

- (5.37) * Which packages is it possible that Sam didn't pick up which are to be mailed tomorrow until it had stopped raining?

In fact, if a relative clause has been extraposed away from its head NP, that NP cannot be questioned. So compare (5.29), which contains such a head NP, with the ungrammatical (5.38), in which this NP has been questioned:

(5.38) * Which packages didn't Sam pick up which are to be mailed tomorrow until it had stopped raining?

Elsewhere (cf. Ross (1966a)), I have pointed out that no elements of an extraposed relative clause may be relativized or questioned. For an example of this restriction, consider (5.39) and its derived structure (5.40).

(5.39) A girl came in who had worn this coat.

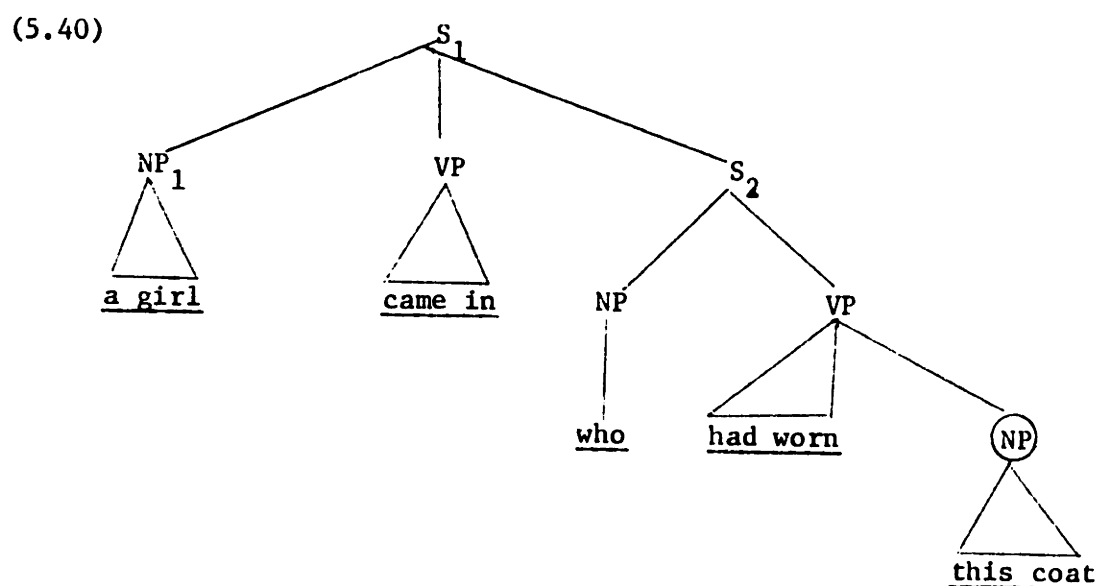

That the circled NP in (5.40) cannot be relativized is apparent from the ungrammaticality of (5.41).

(5.41) * The coat which a girl came in who had worn was torn.

The ungrammaticality of sentences like (5.37), (5.38) and (5.41) seems to call for the adoption of a new constraint, such as the one stated in (5.42):

(5.42) The Frozen Structure Constraint

If a clause has been extraposed from a noun phrase whose head noun is lexical, this noun phrase may not be moved, nor may any element of the clause be moved out of that clause.

The formulation of this constraint is reminiscent of the formulation given in (4.20) -- the Complex NP Constraint. A moment's reflection on the content of the former constraint suffices to reveal why this should be so: what (5.42) says, in effect, is that elements of complex noun phrases, which are prohibited from being moved before the rule of Extrapolation from NP has applied are also prohibited after this rule has applied. In other words, (5.42) must duplicate the constraints which are stated in (4.20) and (4.181), if Extrapolation from NP is allowed to precede transformations like Question and Relative Clause Formation. The solution is obvious: the Frozen Structure Constraint can be dispensed with if the rule of Extrapolation from NP is made a last cyclic rule (recall that there is independent evidence that this rule is not cyclic, since it must follow Particle Movement), and if it follows all movement rules, in particular Question and Relative Clause Formation.

5.1.1.4. Since the structure of the argument I have just presented is highly complex, a review of the main points may prove helpful.

1. Extrapolation is last-cyclic.

There are two arguments for this: (a) if it were cyclic, sentences like (5.5) would be assigned the wrong d.c.s., unless some independently motivated surface structure adjustment rule can be formulated in such a way as to automatically convert (5.9) into (5.6), and (b) it must follow Particle Movement, which the facts of sentence (5.15) show to be last-cyclic.

2. If Extrapolation is last-cyclic, unless it is constrained in some new way, deep structures like (5.17) will be converted into ungrammatical strings like (5.18).

3. The A-over-A principle, though it might be used to block (5.18), cannot be used to block sentences like (5.21), which involve both Extrapolation and Extrapolation from NP, unless it can be argued that these two rules should be collapsed into one rule.

4. Extrapolation must precede Question, because while no elements of subject clauses may be moved out of these clauses, by virtue of the Sentential Subject Constraint, (4.254), if these clauses have been extrapolated, elements in them become movable (compare (4.251b) and (4.251c)).

5. All movement rules, in particular Question, must precede Extrapolation from NP, or else the Frozen Structure Constraint, an otherwise unnecessary condition, which in essence repeats provisions of the Complex NP Constraint and the Left Branch Condition, must be added to the theory of grammar.

6. Since one precedes and the other follows Question, Extrapolation and Extrapolation from NP cannot be collapsed into one rule. In the derivation of sentences like (5.35b), the four rules of Particle Movement, Extrapolation, Question, and Extrapolation from NP must all apply, in the order listed.

7. Therefore, ungrammatical sentences like (5.21) cannot be excluded by any version of the A-over-A principle.

Conclusion: some new type of restriction on rules must be devised and added to the theory of grammar.

5.1.2.

5.1.2.1. Sentences like (5.21), which the argument above shows not to be excludable by any presently available theoretical mechanism, can be blocked if rules can make reference to the boundaries of the first sentence above the elements being operated on. I will refer to a rule as being upward bounded if elements moved by that rule cannot be moved over this boundary. To give a concrete example, the rule of Extrapolation must be marked as being upward bounded. This means that when the structure shown in (5.43) is inspected to determine whether the structural description shown in (4.126) is satisfied, and if so, how the operation of the rule is to be carried out, by universal convention, the variable Y in term 4 of (4.126) will be interpreted as ranging over all nodes of the tree which are below the first double line above the nodes of (5.43) which could be affected by the rule -- S_2 , S_3 , and S_4 . And the instruction in the structural change of (4.126), that the S of term 3 is to be adjoined to the

variable in term 4, will be interpreted to mean that the S is to be adjoined to the largest part of the tree consistent with this convention. That is, the S will move to the right, up to the first double line. Thus depending on whether Extrapolation moves S₂, S₃, or S₄, or any combination of these, (5.43) will become one of the eight sentences of (5.44).¹⁰

(5.43)

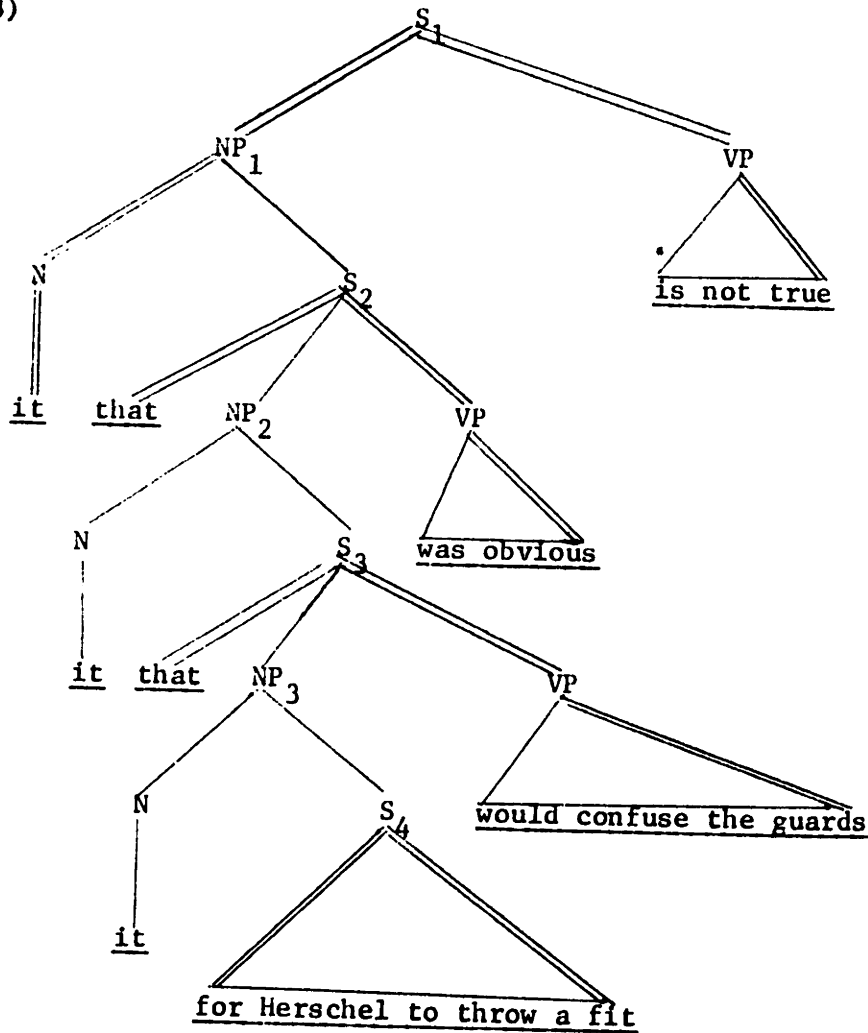

- (5.44)
- a. That that for Herschel to throw a fit would confuse the guards was obvious is not true.
 - b. It is not true that that for Herschel to throw a fit would confuse the guards was obvious.
 - c. That it was obvious that for Herschel to throw a fit would confuse the guards is not true.
 - d. It is not true that it was obvious that for Herschel to throw a fit would confuse the guards.
 - e. That that it would confuse the guards for Herschel to throw a fit was obvious is not true.
 - f. It is not true that that it would confuse the guards for Herschel to throw a fit was obvious.
 - g. That it was obvious that it would confuse the guards for Herschel to throw a fit is not true.
 - h. It is not true that it was obvious that it would confuse the guards for Herschel to throw a fit.

The ungrammaticality of (5.21) shows that the rule of Extrapolation from NP must also be designated as an upward bounded rule.

5.1.2.2. It seems that it is necessary to postulate yet a third extraposition-like rule, to account for related pairs of sentences like those in (5.45).

- (5.45) a. A review of this article came out yesterday.
 b. A review came out yesterday of this article.

It seems possible that the maximally general formulation of this rule which is given in (5.46) may prove correct.

(5.46) Extrapolation of PP

X	-	[P NP] _{NP}	-	.Y	
1		2		3	OPT
					⇒
1		0		3+2	

Arguments similar to those given in § 5.1.1 show this rule to be necessarily last-cyclic. Firstly, if it were in the cycle, it would convert (5.48), which underlies (5.47) into (5.49), instead of converting it into (5.50).

- (5.47) A review seems to have come out yesterday
 of this article.

(5.48)

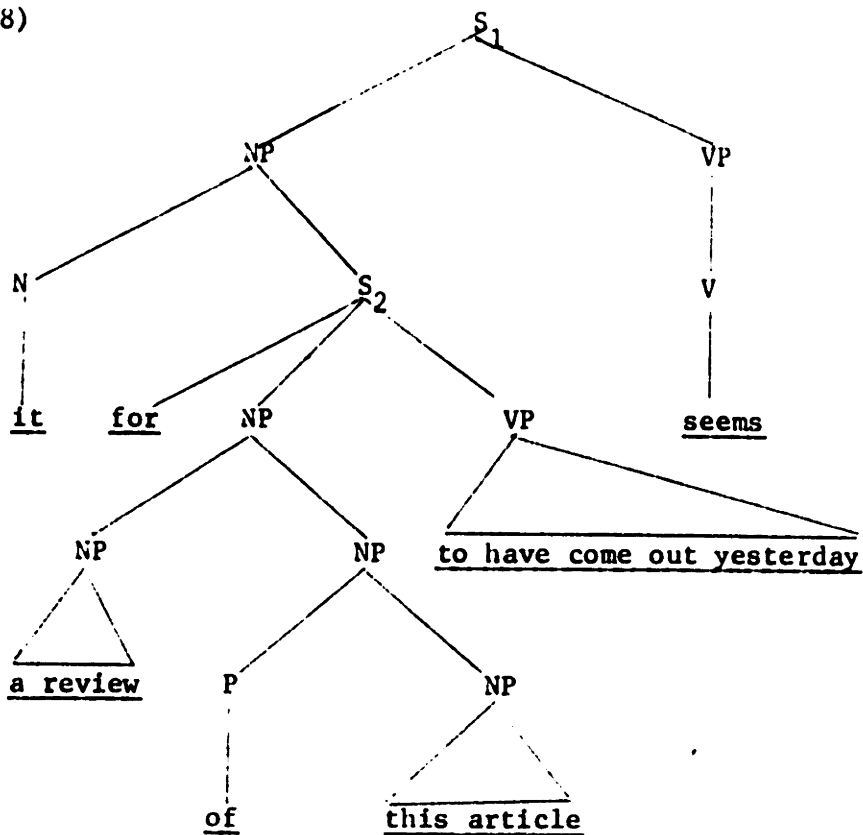

(5.49)

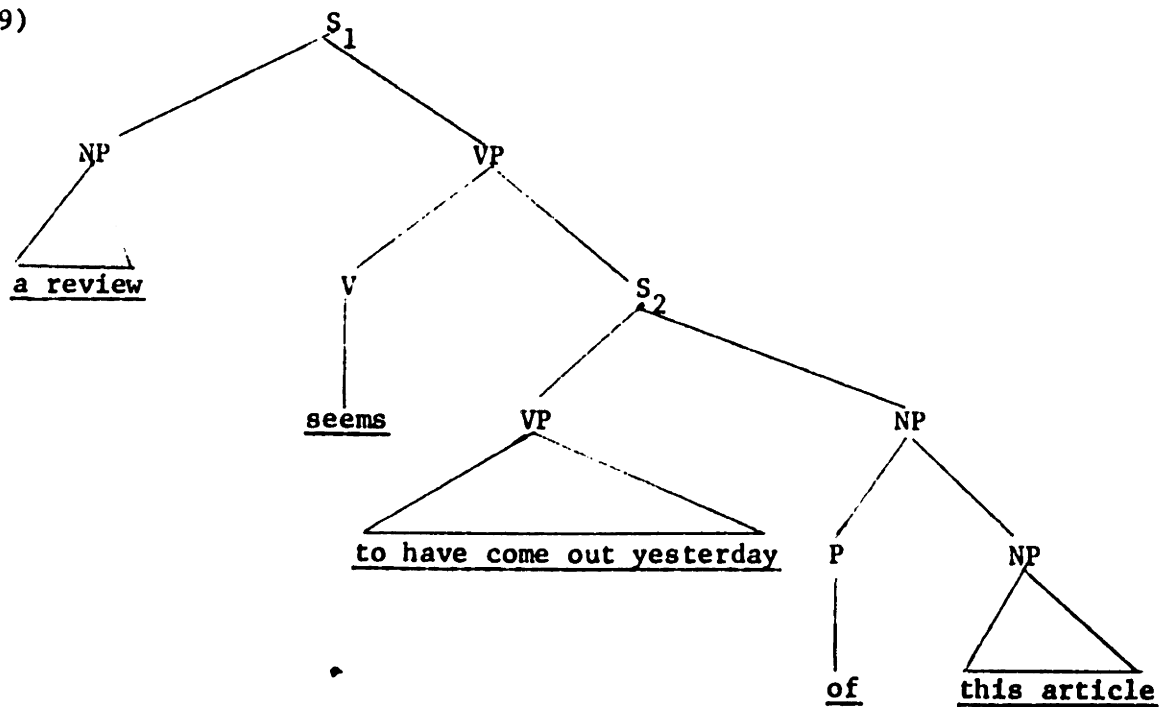

(5.50)

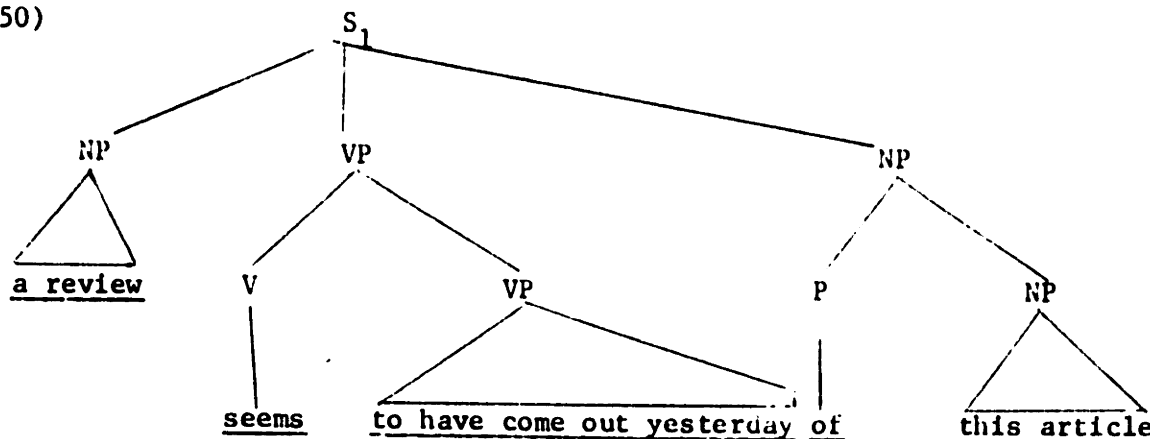

Like (5.9) and (5.27), (5.49) makes incorrect claims about intuitions of constituency -- it claims that the string to have come out yesterday of this article is a constituent -- but unlike these two previous structures, it seems unlikely that the rule which converts (5.12) into a coordinate structure can be extended to effect the conversion of (5.49) into (5.50). Thus if Extrapolation of PP is made a cyclic rule, some new surface structure adjustment rule will be necessary.

Secondly, in order to produce intercalated structures like those of sentences (5.51),

(5.51) Why don't you pick some review up of this article? it will be necessary to order Extrapolation of PP after the last-cyclic rule of Particle Movement. Thus it too must be last-cyclic.

And finally, unless it is last-cyclic, it will be necessary to add the constraint stated in (5.52) to the theory of grammar,

(5.52) If a prepositional phrase has been extraposed out of a noun phrase, neither that noun phrase nor any element of the extraposed prepositional phrase can be moved.

for if (5.53a) is converted by (5.46) into (5.53b) neither of the underlined NP's in (5.53b) can be questioned, as the impossibility of (5.53c) and (5.53d) shows.

- (5.53) a. Ann is going to send a picture of Chairman Mao to her teacher, as soon as she gets home.
- b. Ann is going to send a picture to her teacher of Chairman Mao, as soon as she gets home.
- c. * Which picture is Ann going to send to her teacher of Chairman Mao as soon as she gets home?
- d. * Who is Ann going to send a picture to her teacher of, as soon as she gets home?

But just as condition (5.42) can be dispensed with by making Extrapolation from NP last-cyclic, so (5.52) can be if Extrapolation of PP is last-cyclic.

But if the above three arguments are correct, then the fact that (5.54) can be converted into the structure underlying (5.55a), but not that underlying (5.55b), shows that it too must be designated as being upward bounded.

(5.54)

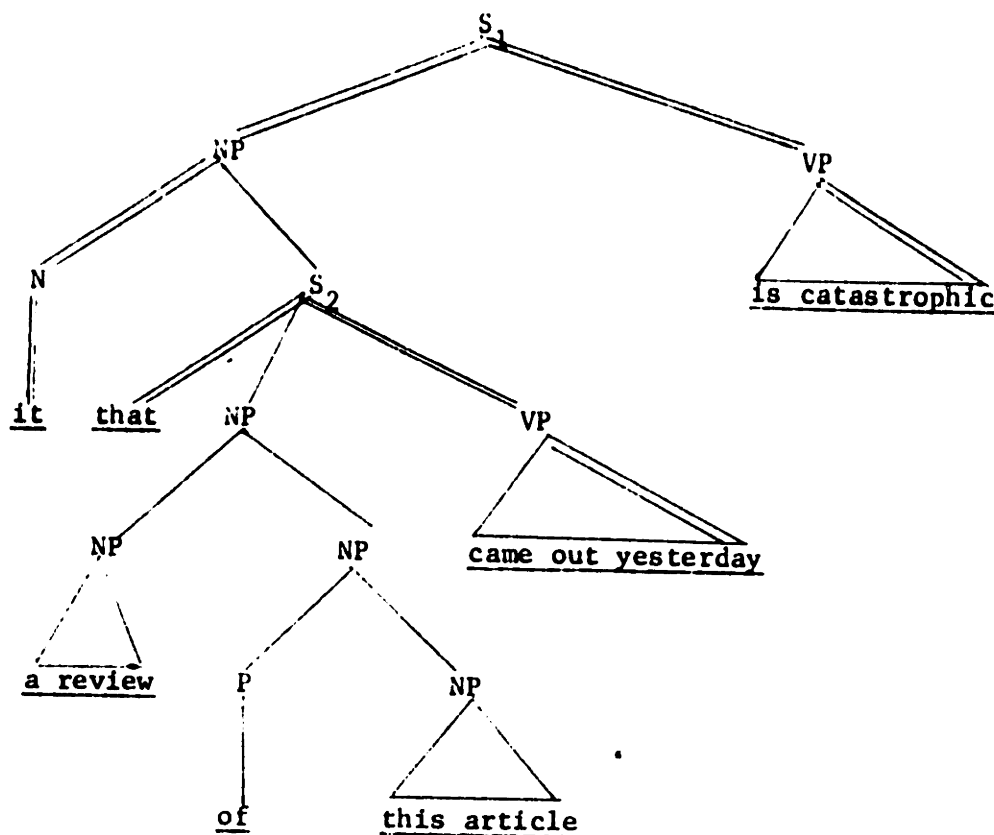

- (5.55) a. That a review came out yesterday of this article is catastrophic.
- b. * That a review came out yesterday is catastrophic of this article.

It seems to me to be possible to collapse Complex NP Shift, (3.26), and Extrapolation of PP, removing condition 1 on (3.26), which specifies that only NP dominating S can undergo the rule, and stipulating that condition 2 applies only if the NP to be shifted does not begin with a preposition. The removal of the first condition will mean that (5.56b), which results from the application of the rule

to (5.56a), will not be considered to be ungrammatical, but rather unacceptable, and to be so designated by Output Condition (3.41).

- (5.56) a. I'll give some to my good friend from Akron.
 b. * I'll give to my good friend from Akron some.

I will henceforth refer to this rule, which is stated in (5.57), as NP Shift.

$$\begin{array}{rcl}
 (5.57) & & \underline{\text{NP Shift}} \\
 & X - \text{NP} - Y & \\
 & 1 \quad 2 \quad 3 & \xRightarrow{\text{OPT}} \\
 & 1 \quad 0 \quad 3+2 &
 \end{array}$$

Condition 1: This rule is last-cyclic.

Condition 2: BLOCKS if $3 = X_1 + \begin{bmatrix} +V \\ -Adj \end{bmatrix}_i + X_2$,
 where there exists no NP which
 dominates $\begin{bmatrix} +V \\ -Adj \end{bmatrix}_i$, and
 $2 \neq [P \text{ NP}]_{\text{NP}}$.

5.1.2.3. Whether or not I am correct in assuming that Complex NP Shift and Extrapolation of PP are the same rule is not of great importance at present. The generalization stated in (5.58) remains true no matter how many rules (5.57) must be broken down into.

- (5.58) Any rule whose structural index is of the form ... A Y, and whose structural change specifies that A is to be adjoined to the right of Y, is upward bounded.

I know of no exceptions to this generalization.

It is probably impossible to maintain that all rules which adjoin terms to the left of a variable are upward bounded, unless the following facts can be explained in some other way than the one I will propose below.

Observe first that sentence (5.59) is ambiguous.

- (5.59) I promised that he would be there around midnight.

The adverb around midnight can either modify be as in (5.60), which is the d.c.s. of one of the readings of (5.59), or it can modify promised, as in (5.61), which is the d.c.s. of the other reading.

(5.60)

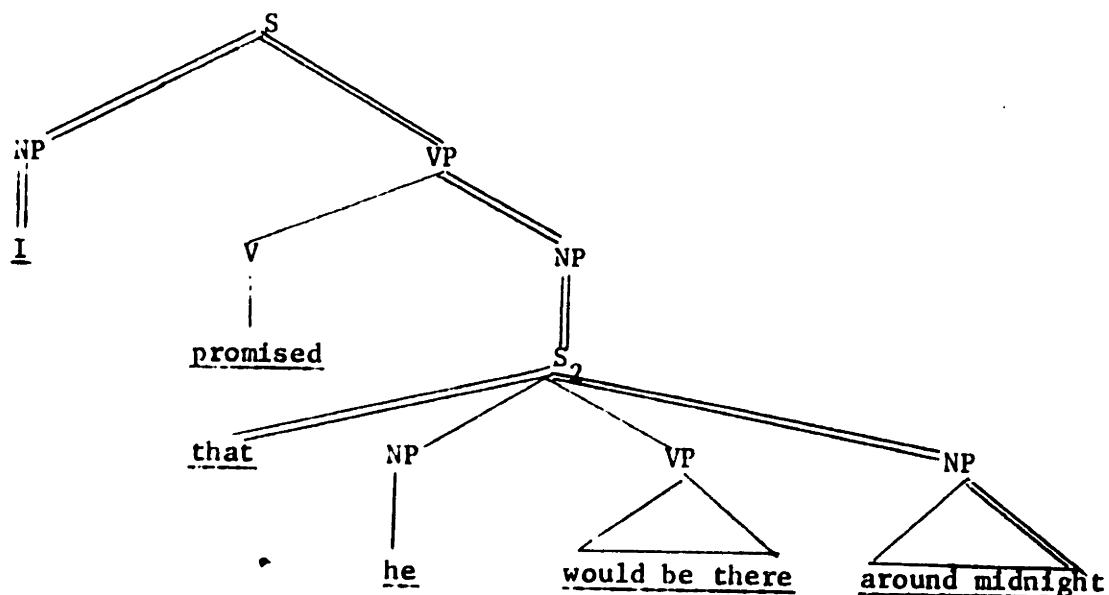

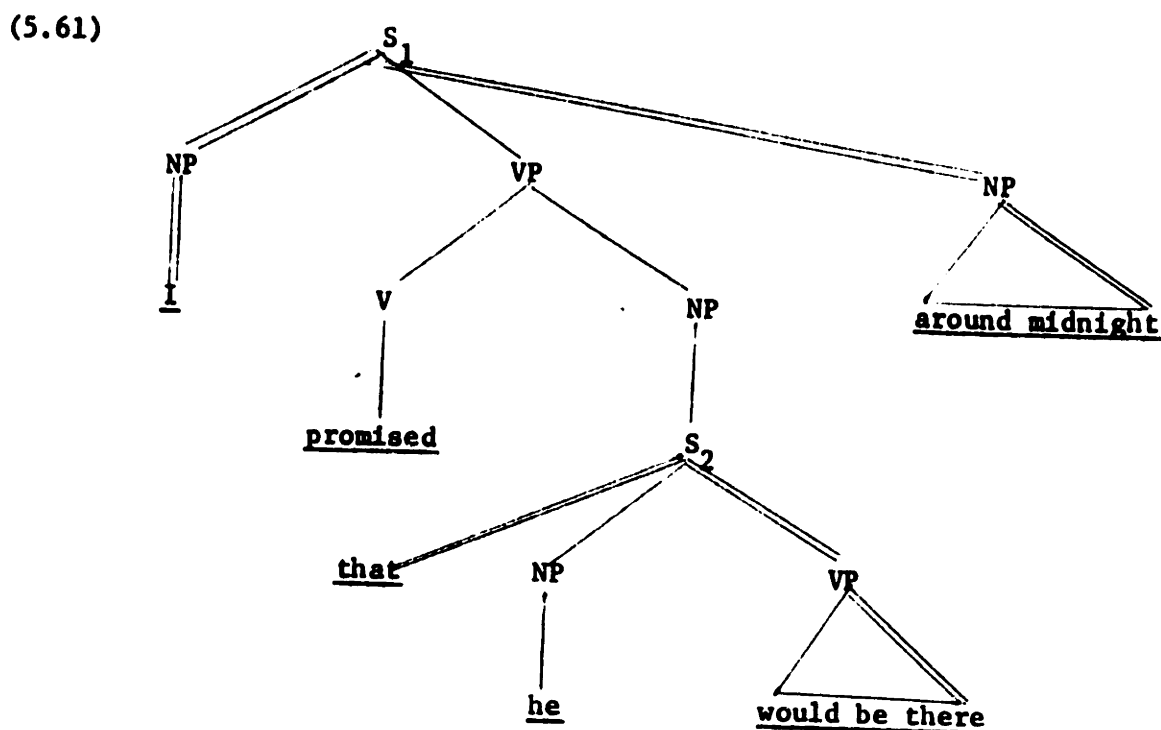

If the adverb is preposed to the front of (5.59), with normal intonation, the resulting sentence, (5.62), is unambiguous:¹¹

(5.62) Around midnight I promised that he would be there.

(5.62) can only be derived from (5.61). This can be demonstrated by a consideration of (5.63).

(5.63) I promised that he would be there tomorrow.

This sentence, unlike (5.59), is unambiguous, and can only be assigned a structure similar to (5.60), for tomorrow cannot modify the past tense verb promised. Now note that the rule of Adverb Preposing, which converts (5.59) into (5.62), cannot convert (5.63) into (5.64), for (5.64) is ungrammatical unless tomorrow bears heavy stress.

(5.64) Tomorrow I promised that he would be there.
The adverb tomorrow can be preposed, but only to the front of the embedded clause, as is the case in (5.65).

(5.65) I promised that tomorrow he would be there.
Similarly, on the reading of (5.59) where the adverb modifies the embedded verb, as in (5.60), it can be preposed to yield (5.66).

(5.66) I promised that around midnight he would be there.

Thus it seems that we must propose the following rule:

(5.67) Adverb Preposing¹²

X	-	[+Adverb]	-	Y	
1		2		3	$\xrightarrow{\text{OPT}}$
2 + 1		0		3	

Condition 1: This rule is last-cyclic.

Condition 2: This rule is upward bounded.

It should be obvious why this rule must be last-cyclic: if it were cyclic, it would cause the structural descriptions of such cyclic rules as Equi NP Deletion, Complementizer Placement, Passive and It Replacement to be complicated. However, if it is a last-cyclic rule, the only way to prevent the adverb around midnight from incorrectly being preposed to the front of S_1 in (5.60), instead of to the front of S_2 , is to mark it as being upward bounded.

But now let us reconsider sentences (5.62) and (5.64), when the preposed adverbs have heavy stress. Sentence (5.62) becomes ambiguous, and sentence (5.64), ungrammatical without such a stress, becomes grammatical. Such stress and intonation also appears in such sentences as those in (5.68):

- (5.68) a. Beans I don't like.
 b. Proud of him I've never been.

Such sentences are generated by (4.185), the rule of Topicalization. Topicalization is not a bounded rule, as such examples as (5.69) show.

- (5.69) Beans I don't think you'll be able to
 convince me Harry has ever tasted in his
 life.

In light of these remarks about Topicalization, it seems reasonable to suppose that the versions of (5.62) and (5.64) in which the preposed adverbs have heavy stress should be analyzed as resulting from the application of the rule of Topicalization, not Adverb Preposing. Thus these facts seem to indicate that there is a syntactic minimal pair here: while all rules which adjoin elements to the right of variables are upward bounded, rules which adjoin elements to the left of variables must be marked idiosyncratically, for some are upward bounded, and some are not.

There is, however, one possibility of avoiding such a conclusion. It is possible that topicalized sentences such as (5.64),

(5.68), and (5.69) should not be derived directly by the rule of Topicalization which was stated in (4.185), but rather from such "cleft sentences" as those in (5.70), by means of a rule which deletes the it, the copula and the relative pronoun in these sentences (sometimes obligatorily), thus converting them into the corresponding topicalized sentences.

- (5.70)
- a. It was tomorrow that I promised that he would be there.
 - b. It is beans that I don't like.
 - c.* It is proud of him that I have never been.
 - d. It is beans that I don't think you'll be able to convince me Harry has ever tasted in his life.

But while such a derivation is possible, I know of no compelling arguments which indicate that it is necessary. And until such arguments can be found, the generalization stated in (5.58) cannot be extended. Nevertheless, the fact that (5.58) holds in all cases I know of in which terms are permuted rightwards around variables means that it is not necessary to complicate the formulations of the three rules of Extraposition, Extraposition from NP, and NP Shift which would have to be given in the grammar of English or of any other particular language. In other words, while neither the principle of the transformational cycle, nor the A-over-A principle, nor any of the constraints discussed in Chapter 4, is powerful enough to block the

derivation of such sentences as (5.21) or (5.55b), this can be accomplished by defining a notion of bounding and adding the empirical generalization contained in (5.58) to the theory. In the following sections I will show that the notion of bounding is necessary to account for other kinds of facts as well.

5.1.3.

5.1.3.1. In this section, I will show that the notion of bounding is useful in restricting the power of rules which introduce features, as well as movement rules like those discussed in § 5.1.2. One well-known rule of this type is the rule of Indefinite Incorporation, (5.71) which Klima proposed in his important article "Negation in English" (Klima (1964)).

(5.71) Indefinite Incorporation

- a. X - [+ Affective] - Y - [+ Indeterminate] - Z
 1 - 2 - 3 - 4 - 5 \Longrightarrow
 1 - 2 - 3 - $\left[\begin{array}{c} 4 \\ +\text{Indefinite} \end{array} \right]$ - 5
- b. X - [+ Indeterminate] - Y - [+ Affective] - Z
 1 - 2 - 3 - 4 - 5 \Longrightarrow
 1 - $\left[\begin{array}{c} 2 \\ + \text{Indeterminate} \end{array} \right]$ 3 - 4 - 5

In this rule, negatives, questions, the word only in certain contexts, and certain lexical items which Klima refers to as "adversatives" (op. cit. p. 314) trigger the change from indeterminate

quantifiers like some, to indefinite ones like any. Klima uses the feature [+ Affective] to mark those elements which can trigger this change. Some examples of the effects of (5.71) can be seen by comparing the sentences of (5.72) with their corresponding members in (5.73).

- (5.72)
- a. * I won't have some money.
 - b. I $\left. \begin{array}{l} \text{will} \\ \text{won't} \end{array} \right\}$ ask you to believe that he tried to force me to give her some money.
 - c. Do you think that he sometimes went there alone?
 - d. That he sometimes went there alone is $\left. \begin{array}{l} \text{certain} \\ \text{odd} \end{array} \right\}$.
 - e. Do you believe (the claim) that somebody was looking for something?
 - f. I never met that man who somebody tried to kill.
- (5.73)
- a. I won't have any money.
 - b. I $\left\{ \begin{array}{l} * \text{will} \\ \text{won't} \end{array} \right\}$ ask you to believe that he tried to force me to give her any money.
 - c. Do you think that he ever went there alone?¹³
 - d. That he ever went there alone is $\left\{ \begin{array}{l} * \text{certain} \\ \text{odd} \end{array} \right\}$.
 - e. Do you believe (*the claim) that anybody was looking for anything?
 - f. * I never met that man who anybody tried to kill.

The ungrammaticality of (5.72a) shows that there are cases where the rule is obligatory. The ungrammaticality of (5.73b), if there is no negative in the sentence, is indicative of the fact that some's can be converted into any's indefinitely far away from the triggering [+Affective] element. (5.73c) shows that the change can take place in questions, and (5.73d) shows why rule (5.71) must be formulated in such a way that the change can operate backwards as well as forwards, and also that the adjectives certain and odd must differ in their marking for the feature [Affective]: the first must be marked [-Affective], the second [+Affective].

With respect to such sentences as (5.73b), which show the infinite scope of (5.71), Klima remarks that the change can take place in the same clause as the one in which the [+Affective] element appears, or in any clause subordinate to it. The definition of "subordinate" which he proposes makes use of the notion in construction with, which I will discuss in § 5.2.2 below, but this notion is not powerful enough to block (5.73f) or the version of (5.73e) in which the head noun the claim appears. The fact that (5.71) will neither go down into clauses in apposition to sentential nouns nor into relative clauses makes it similar to reordering transformations like Question and Relative Clause Formation in a way which I will argue in § 6.4 is anything but coincidental.

Notice that there are other environments in which some is not converted to any. The sentences in (5.74) must not be operated upon by rule (5.71) to produce the ungrammatical strings of (5.75).

- (5.74) a. Tom told somebody that he wasn't sick.
 b. That Sam sometimes didn't sleep must have pleased somebody.
 c. Buffy couldn't do 100 pushups and somebody laughed.
- (5.75) a. * Tom told anybody that he wasn't sick.
 b. * That Sam sometimes didn't sleep must have pleased anybody.
 c. * Buffy couldn't do 100 pushups and anybody laughed.

The sentences in (5.74) have the structures shown in

(5.76).

(5.76) a.

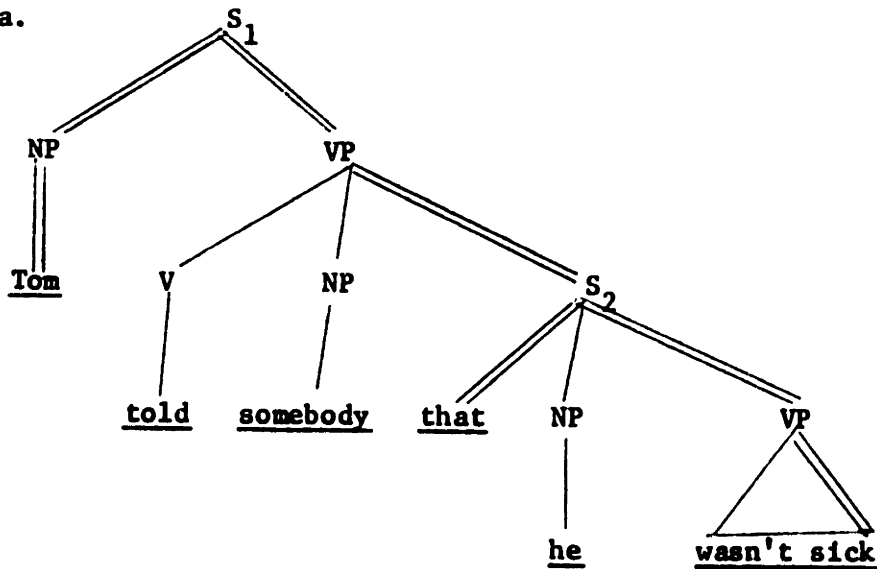

(5.76) b.

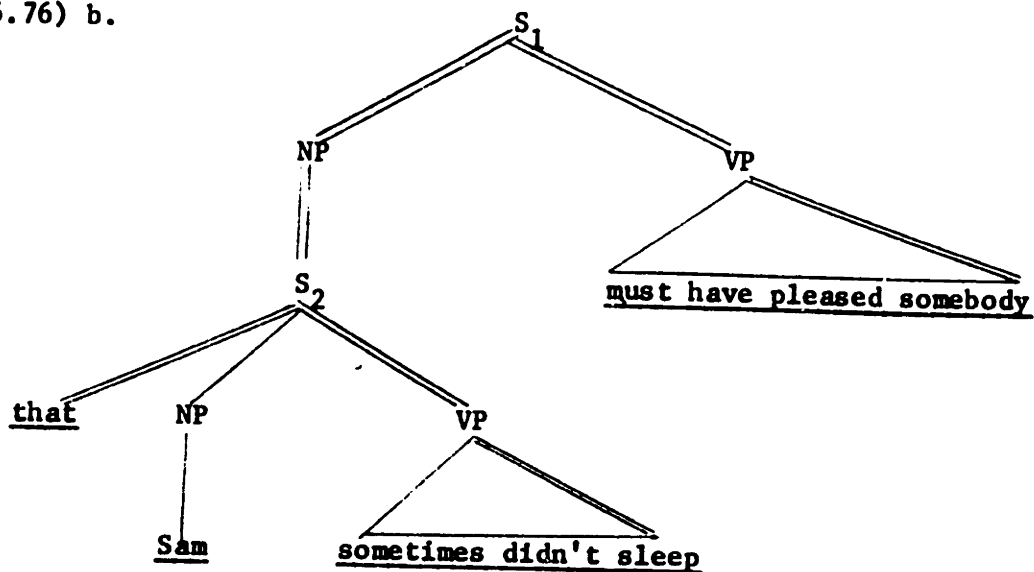

(5.76) c.

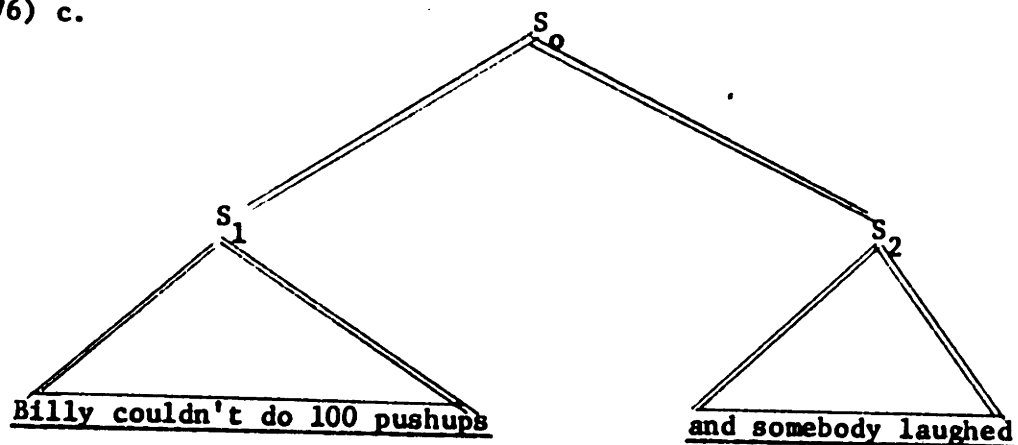

If one thinks of rule (5.71) in slightly metaphorical terms, imagining the [+Affective] element as being a source which "broadcasts" the feature [+Indefinite] through the tree, the ungrammatical sentences in (5.75) can be blocked, provided that this broadcasting is upward bounded, and is not permitted to cross the first double line up from the [+Affective] source. In other words, while rule (5.71) can effect

changes indefinitely far down the tree from the element that causes the change, no elements of sentences higher up the tree than this element will be affected.

Restricting the rule of Indefinite Incorporation by making it upward bounded, in the sense I have just discussed, is adequate to the task of excluding the sentences in (5.75), but it is not strong enough to block (5.73e) and the ungrammatical version of (5.73f). The problems posed by these sentences will be taken up again in § 6.4 below. What concerns us at present is not a more precise statement of rule (5.71), but rather the following generalization about all rules of the same form as this rule:

- (5.77) All feature-changing rules 'except pronominalization rules are upward bounded.

By "feature-changing rule" I mean any rule whose structural index is of the form (5.78a), and whose structural change is of the form of either (5.78b) or (5.78c).

- (5.78) a. ... A_1 ... A_2 ...
 b. ... A_1 ... $\begin{bmatrix} A_2 \\ +F \end{bmatrix}$...
 c. ... $\begin{bmatrix} A_1 \\ +F \end{bmatrix}$... A_2 ...

That it is necessary to specifically exclude rules of pronominalization from the generalization in (5.77) can be seen from (5.79a) and (5.79b), which are of exactly the same syntactic type as

(5.74b) and (5.74c). The latter two become ungrammatical if rules like (5.71) are allowed to apply to them, while the former two cause no problems under pronominalization operations, as the grammaticality of the sentences in (5.80) shows.

(5.79) a. That Sam_i sometimes didn't sleep must have pleased Sam_i.

b. Billy_i couldn't do 100 pushups, and Billy_i broke down and cried.

(5.80) a. That Sam_i sometimes didn't sleep must have pleased him_i.

b. Billy_i couldn't do 100 pushups and he_i broke down and cried.

It is at present an unexplained mystery why it is that rules of pronominalization do not conform to (5.77). It will be seen in § 6.4 below that these rules violate another extremely general constraint on feature-changing rules, again, for no presently explicable reason. But the large number of feature-changing rules which are upward bounded, of which the rules in the next section constitute a small sample, suggest to me that (5.77) is essentially correct, and that other factors must be involved in pronominalization.

5.1.3.2.

5.1.3.2.1. As a second example of an upward bounded feature-changing rule, let us consider facts from Finnish which are closely related to the facts of Indefinite Incorporation in English.

The Finnish verb tuomaan 'to bring' normally takes an accusative direct object, as in (5.81).

(5.81) (Minä)¹⁴toin kirjan.

'I brought the book (acc.)'

Although it is possible to construct sentences such as (5.82), where the object NP is in the partitive case, such sentences are unusual and would only be used to convey some such meaning as "I spent my whole life bringing the book."

(5.82) Toin kirjaa.

'I brought the book (part.)'

But if sentence (5.81) is negated, as in (5.83), the object NP must be converted to the partitive case.

(5.83) En tuonut kirjaa.

Not I brought the book (part.).

'I didn't bring the book.'

The presence of a negative in a higher sentence can cause accusatives to change to partitives in sentences indefinitely far down the tree from the negative morpheme. (5.84) shows a simple case where an element of an originally embedded S changes its case.

(5.84) En pyytänyt häntä tuomaan kirjaa.

not I asked him to bring a book (part.).

'I didn't ask him to bring a book.'

Inspection of various other facts, which I will not take up in detail here, reveals that the Finnish rule, unlike the English rule,

cannot go backwards, so the rule can be formulated, in first approximation, as in (5.85).

(5.85) Finnish Partitive Introduction

X - [+Neg] - Y - [+acc] - Z

OBLIG

1 - 2 - 3 - 4 - 5

1 - 2 - 3 - $\left[\begin{array}{c} 4 \\ +part \end{array} \right]$ - 5

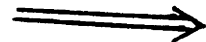

Since this rule has the form of (5.78), (5.77) will make it upward bounded. That this is necessary can be seen from the following sentences. If (5.84) is changed so that the negative morpheme en is removed, and the subject minä 'I' is replaced by a NP containing a relative clause in which a negative appears, as in (5.86),

(5.86) Poika joka ei mennyt pyytänyt hentä tuomaan $\left\{ \begin{array}{l} \text{kirjan} \\ *kirjaa \end{array} \right\}$.

Boy who not went asked him to bring book

'The boy who didn't go asked him to bring a book.'

then it is no longer possible to have the object NP of the verb tuomaan 'to bring' in the partitive case, except with the unusual sense of (5.82). The structure of (5.86) is that shown in (5.87),

(5.87)

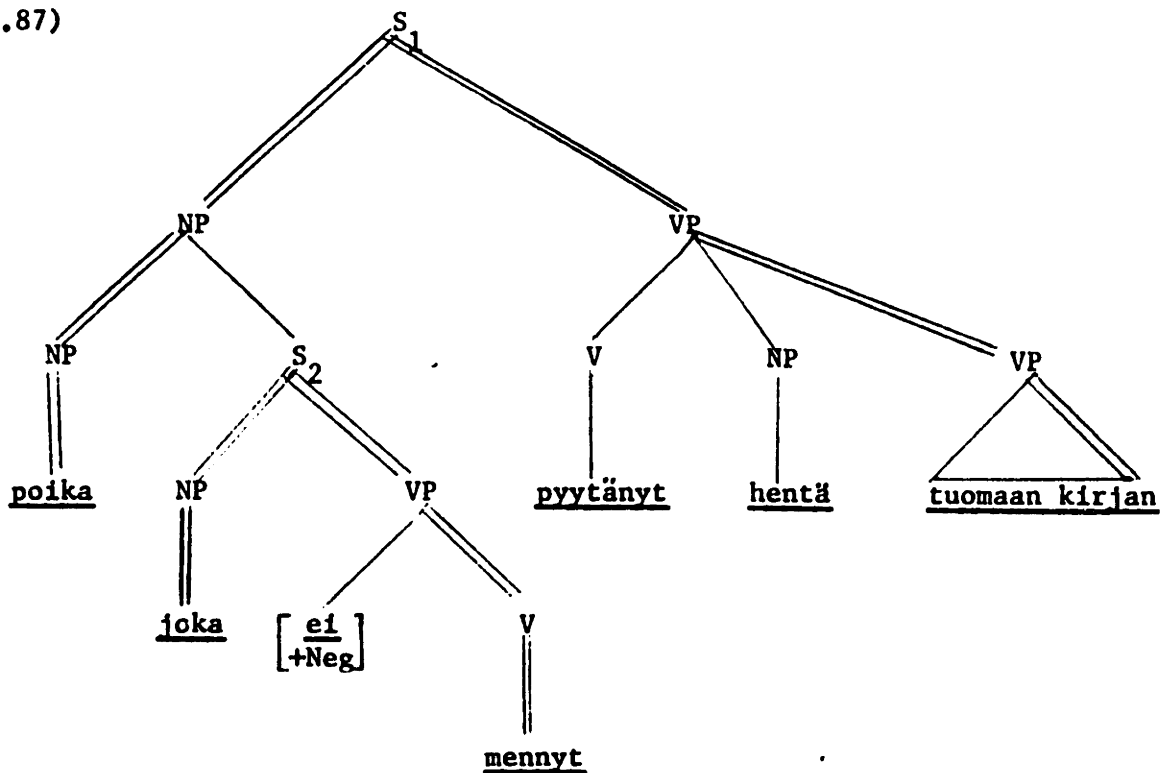

and since the negative morpheme ei is to the left of and below the double line emanating from S_2 in (5.87), if (5.85) is upward bounded, the NP kirjan (acc.) 'book' will correctly be prevented from being converted to kirjaa (part.) 'book'. Another case showing the same restriction is that of (5.88a), which rule (5.85) must change to (5.88b), but not (5.88c).

- (5.88) a. En tuonut kirjan, mutta toin lehden.
 Not I brought book (acc.), but I brought paper (acc.)
- b. En tuonut kirjaa, mutta toin lehden.
 Not I brought book (part.), but I brought paper (acc.)
 'I didn't bring the book, but I brought the paper.'

c. * En tuonut kirjaa, mutta toin lehteä.

Not I brought book (part.), but I brought paper (part.)

Since the structure of (5.88b) is that shown in (5.89), it is clear that upward bounding will once again suffice to prevent the undesired change from taking place.

(5.89)

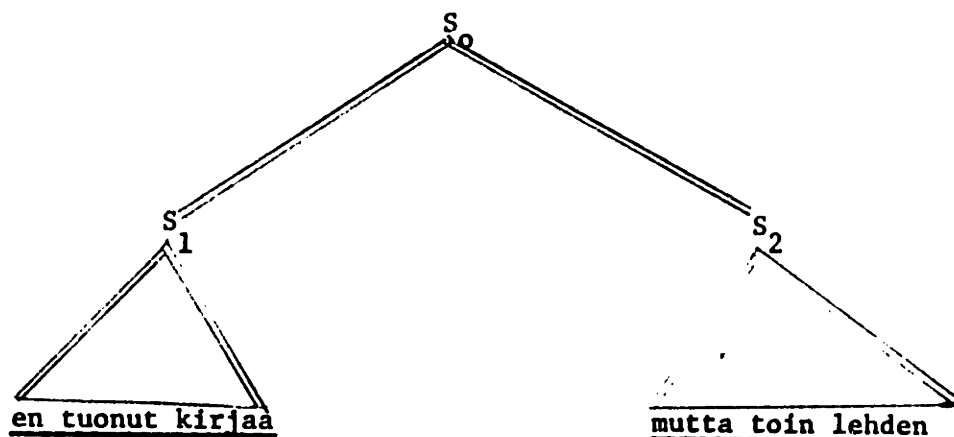

5.1.3.2.2. In Russian, too, there is a rule which changes case in the presence of negatives. So while the direct object eto 'this' in (5.90a) is accusative, if the negative morpheme ne is introduced, eto (acc.) is changed to etovo (gen.).

(5.90) a. ja eto sdelal

I this (acc.) did

'I did this.'

b. ja etovo ne sdelal

I this (gen.) not did

'I didn't do this.'

A negative in a higher clause can cause cases to change in infinitival complements, under various complicated conditions which I will not deal with here. (5.91) is one example of such a change.

(5.91) ja ne xoču $\left\{ \begin{array}{l} \text{eto} \\ \text{etovo} \end{array} \right\}$ sdelat.
 I not want this (acc. or gen.) to do
 'I don't want to do this.'

It is not clear to me that examples like (5.91), where the genitive case depends on a higher negative, can be extended to any desired length, as is the case in English and Finnish (cf., e.g., (5.73b)), for the restrictions on this Russian rule have to do with the verbs of the sentences separating the negative element from the accusative noun phrase which the rule is to operate on. For example, the verb xotet, 'want' allows the negative to affect noun phrases in its complement, while the verb načat, 'begin' does not. The class of verbs like xotet, appears to be small, and it may not be possible to construct sentences of any desired length in which there are unbroken sequences of adjacent sentences whose main verbs are of this class. If this is ^{not} possible, it may be possible to reformulate the rule I give below in (5.92) in such a way that no variable is necessary between terms 2 and 4. In this case, the facts of (5.93) and (5.94) would not constitute proof that (5.92) must be upward bounded, so these facts from Russian could not be used in support of (5.77).

(5.92) Russian Genitive Introduction¹⁵

$$X - [+Neg] - Y - [+acc] - Z$$

$$1 - 2 - 3 - 4 - 5 \quad \Longrightarrow$$

$$1 - 2 - 3 - \left[\begin{array}{c} 4 \\ [+gen] \end{array} \right] - 5$$

If it is necessary to state this rule with a variable as term 3, then facts which parallel those of (5.86) and (5.88) can be adduced to show that (5.92) must be upward bounded. While the rule can change vodku (acc.) 'vodka' to vodki¹⁶, thereby converting (5.93a) to (5.93b), it must be prevented from converting eto to etovo to yield the ungrammatical (5.93c).

- (5.93) a. čelovek kotoryj ne pil vodku sdelal eto.
 man who not drank vodka (acc.) did this (acc.)
 'The man who didn't drink vodka did this.'
- b. čelovek kotoryj ne pil vodki sdelal eto.
 man who not drank vodka (gen.) did this
 'The man who didn't drink vodka did this.'
- c. * čelovek kotoryj ne pil vodki sdelal etovo.

As was the case in Finnish, since the negative morpheme is in a relative clause, it can effect no changes in higher levels of the tree -- (5.92) must be upward bounded. And for the same reasons that (5.88a) could be converted to (5.88b), but not to (5.88c), (5.94a) must be converted to (5.94b), but cannot be converted to (5.94c).

- (5.94) a. ja eto ne sdelal, no eto ja sdelal
 I this (acc.) not did but this (acc.) I did
 'I didn't do this, but I did do this.'
- b. ja etovo ne sdelal, no eto ja sdelal.
 I this (gen.) not did, but this (acc.) I did
 'I didn't do this, but I did do this.'
- c. * ja etovo ne sdelal, no etovo ja sdelal.

The structure of (5.94b) is that shown in (5.95):

(5.95)

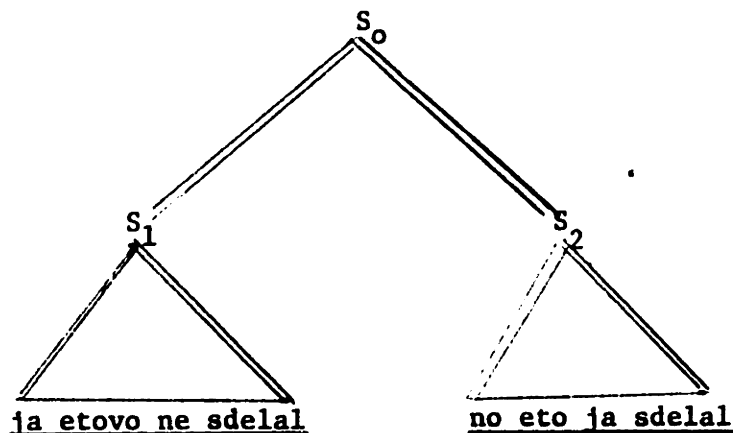

Since the negative morpheme ne is upward bounded, the eto (acc.) in the second clause will be prevented from being converted to etovo (gen.), and the ungrammatical (5.94c) will not be generated.

5.1.3.2.3. As was noted in footnote 15, the Russian rule of Reflexivization can affect noun phrases which were in different clauses in deep structure. An example of the operation of this rule is provided in (5.96), where (5.96a) is obligatorily converted to (5.96b).

- (5.96) a. * on_i uvažajet jevo_i
 he respects him (acc.)
 b. on_i uvažajet sebja_i
 'He respects himself.'

An example showing the conversion of an NP which is the object of an infinitive into a reflexive pronoun is the optional change of (5.97a) into (5.97b).

- (5.97) a. on_i sostavil menja uvazat, $\left. \begin{array}{l} \text{jevo}_i \\ \text{sebja}_i \end{array} \right\} 17$.
 b. 'He forced me to respect $\left. \begin{array}{l} \text{him} \\ \text{himself} \end{array} \right\} .$ '

The rule which effects these changes 'is approximately that stated in (5.98).

(5.98) Reflexivization

X - NP - Y - NP - Z

1 2 3 4 5 \Longrightarrow

1 2 3 $\left[\begin{array}{c} 4 \\ +\text{Refl} \end{array} \right]$ 5

Condition: 2 = 4

By the generalization in (5.77), this rule will be marked as being upward bounded. That this is necessary can be seen from the fact that (5.99a) cannot be converted into (5.99b) by rule (5.98).

- (5.99) a. ženščina kotoruju on_i ljubil sostavila
 woman who he loved forced
menja uvažat, jevo_i.
 me to respect him
 'The woman who he loved forced me to respect
 him.'
- b. * ženščina kotoruju on_i ljubil sostavila
menja uvažat, sebja_i.

The string of words in (5.99b) is a grammatical sentence, and can mean either 'The woman who he loved forced me to respect her' or 'The woman who he loved forced me to respect myself.' But it cannot be synonymous with (5.99a), which is the reading which is of interest here. Since (5.99a) has the structure shown in (5.100), the fact that (5.98) is upward bounded will prevent this undesired conversion from taking place.

(5.100)

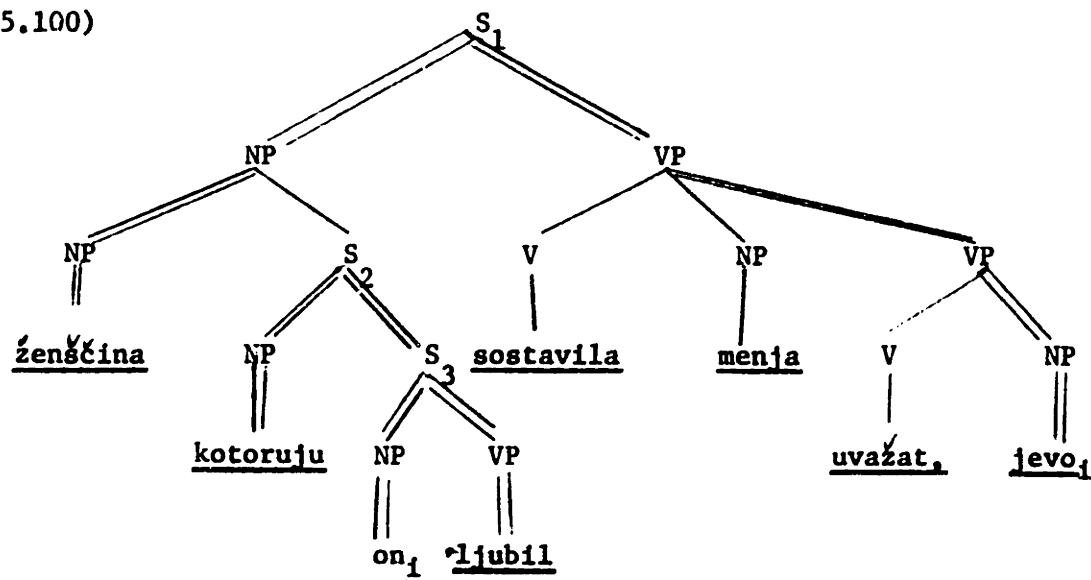

Similarly, (5.101a) must not be converted into (5.101b).

(5.101) a. on_1 ljubiti žensčinu, i ja uvažaju jevo₁.
'He₁ loves the woman, and I respect him₁.'

b. * on_1 ljubiti žensčinu, i ja uvažaju sebja₁.

Once again, (5.101b) has a meaning, but not the same meaning that (5.101a) has. It means 'He loves the woman, and I respect myself.' Since (5.101a) has the structure shown in (5.102),

(5.102)

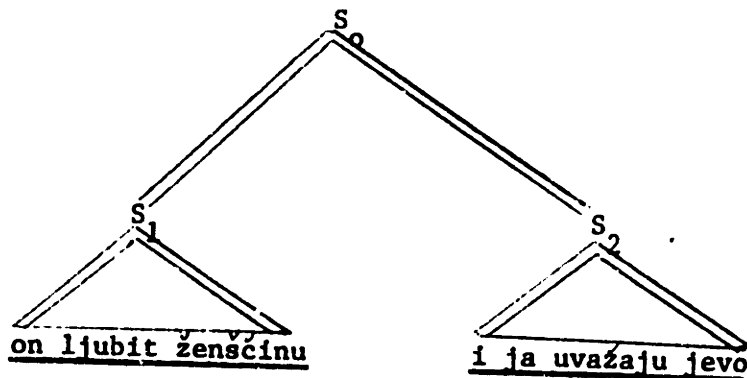

this conversion will be prevented by the fact that rule (5.98) is upward bounded.

At present, (5.98) is still too strong, for it will allow (5.103a) to be converted into (5.103b).

(5.103) a. on_1 znaeti što ona ljubiti jevo₁.

'He₁ knows that she loves him₁.'

b. * on_1 znaeti što ona ljubiti sebja₁.

While (5.103b) can mean 'He knows that she loves herself', it cannot be synonymous with (5.103a). Therefore, reflexives must

somehow be prevented from being introduced into subordinate clauses.
I will defer discussion of this problem until § 6.4 below.

5.1.3.2.4. In Japanese, the reflexive pronoun zibun, which, like sebja, is used for all persons, can be introduced into clauses, as the conversion of (5.104a) into (5.104b), whose structure is shown in (5.105), demonstrates:

- (5.104) a. Mary₁ wa kare₁ ga byooki de aru to iu
Mary she sick is that say
koto o sinzite iru.
thing believing is.

'Mary₁ believes that she₁ is sick.'

- b. Mary₁ wa zibun₁ ga byooki de aru to iu
koto o sinzite iru.

(5.105)

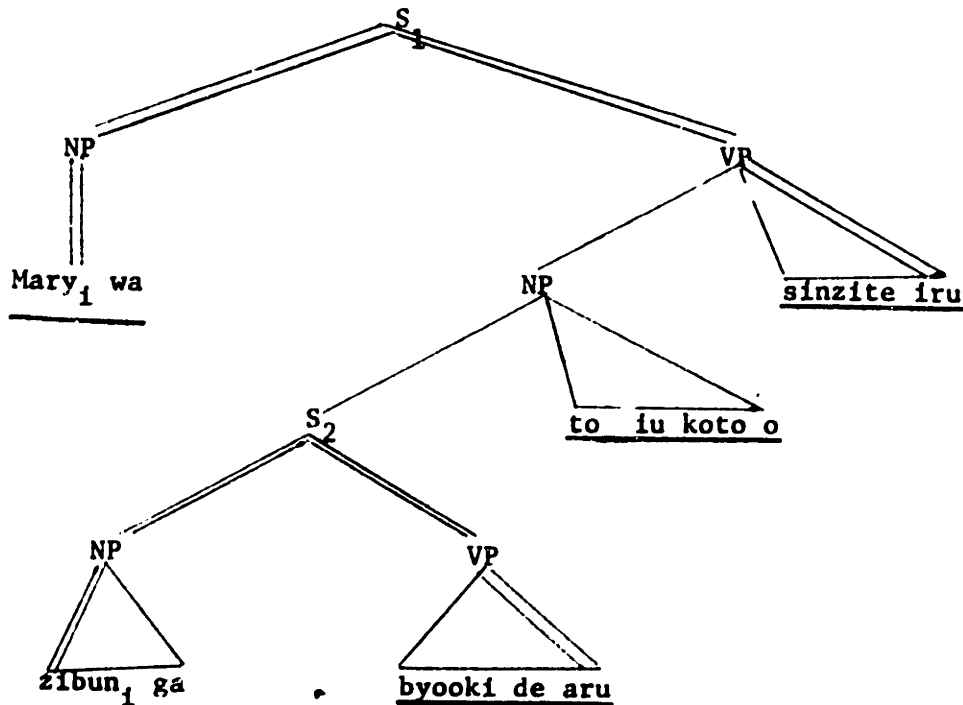

Since the circled antecedent NP in (5.107) is to the left of and below a double line, as seen from the boxed NP, upward bounding will prevent rule (5.98) from converting this structure into (5.106b).

5.1.3.2.5. For a sixth example of a feature-changing rule which is upward bounded, let us return to Finnish. The rule stated in (5.108)

(5.108) Finnish Nominative Introduction

$$\begin{array}{ccccccc}
 V & - & X & - & \left[\begin{array}{c} +acc \\ -Pro \end{array} \right] & - & Y \\
 1 & & 2 & & 3 & & 4 & \xrightarrow{\text{OBLIG}} \\
 1 & & 2 & & \left[\begin{array}{c} 3 \\ +nom \end{array} \right] & & 4
 \end{array}$$

accounts for the fact that in sentences whose subjects have been deleted, e.g., in impersonal sentences, or in imperatives like (5.110b), all non-pronominal noun phrases in the accusative case are converted to the nominative case. Thus in (5.109), which at this stage of the derivation still has a subject minä 'I', the direct objects of the verbs pyytää 'to ask' and tuomaan 'to bring' appear in the accusative case.

(5.109) Minä koetin pyytää pojan tuomaan
 'I am trying to ask the boy (acc.) to bring
 kirjan.
 the book (acc.).'

But in the structure underlying an imperative sentence, after the subject NP sinä 'you' has been deleted, as in (5.110), the direct objects must be converted to the nominative case. Thus (5.110a) must become (5.110b).

- (5.110) a. Koeta pyytää pojan tuomaan kirjan.
 try to ask the boy (acc.) to bring the book (acc.)
- b. Koeta pyytää poika tuomaan kirja.
 'Try to ask the boy (nom.) to bring the book (nom.).'

That (5.108) must be upward bounded can be seen from the fact that (5.11a), whose structure is that shown in (5.112),¹⁹ must be converted into (5.111b), and not into (5.111c).

- (5.111) a. Tuo kirjan, ja minä tuon
 you bring the book (acc.) and I will bring
 lehden.
 the paper (acc.)
- b. Tuo kirja, ja minä tuon lehden.
 'Bring the book (nom.), and I'll bring the paper (acc.).'
- c. * Tuo kirja (nom.), ja minä tuon lehti (nom.).

(5.112)

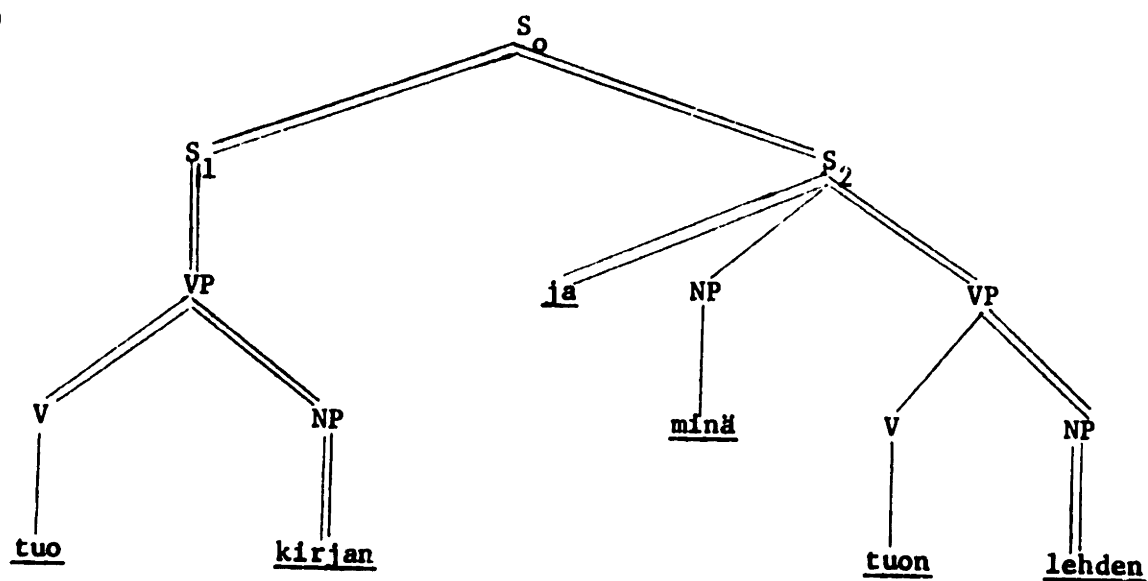

5.1.3.2.6. The last feature-changing rule which I will discuss in support of (5.77) is the rule which changes tense, in some contexts obligatorily, so that it agrees with the tense of some other verb in the sentence. Thus while both is and was are possible in (5.113), only was is in (5.114).²⁰

- (5.113) I believe that the sun $\left. \begin{array}{l} \text{is} \\ \text{was} \end{array} \right\}$ out.
- (5.114) I believed that the sun $\left. \begin{array}{l} * \text{is} \\ \text{was} \end{array} \right\}$ out.

Although much more research must be done on this traditional phenomenon of sequence of tenses, it seems reasonable to me to assume that the rule which effects the change of tense must be formulated roughly as shown in (5.115).

- (5.115) Sequence of Tenses
- a. X - $\left[\begin{array}{l} +V \\ \alpha \text{Tense} \end{array} \right]$ - Y - [+V] - Z
- 1 2 3 4 5 \Longrightarrow
- 1 2 3 $\left[\begin{array}{l} 4 \\ \alpha \text{Tense} \end{array} \right]$
- b. X - [+V] - Y - $\left[\begin{array}{l} +V \\ \alpha \text{Tense} \end{array} \right]$ - Z
- 1 2 3 4 5 \Longrightarrow
- 1 $\left[\begin{array}{l} 2 \\ \alpha \text{Tense} \end{array} \right]$ 3 4 5

It is necessary to formulate this rule so that it can apply in both directions, so that sentences like (5.116) will be excluded.

- (5.116) * That the sun is out was obvious.

That this rule is far too strong can be seen from the fact that it would only allow the version of (5.113) in which is appears to be generated. This indicates that the tense agreement which rule (5.115) effects is much too simple-minded a change, and that the correct rule will have to provide for a much more complex mapping.

It is equally obvious, upon a moment's introspection, that (5.115) must be upward bounded, so that it will allow the generation of both versions of (5.117).

(5.117) That I believed that the sun was out $\left. \begin{array}{l} \text{is} \\ \text{was} \end{array} \right\}$ obvious.

If rule (5.115) were not upward bounded, it would make all the tenses in (5.117) agree with believed (or with one of the other verbs in (5.117)), thus making the incorrect claim that sentences cannot "mix tenses", and that the version of (5.117) containing is is ungrammatical.

The six examples in this section of upward bounded feature-changing rules provide compelling evidence that the generalization expressed in (5.77) is a correct one. Further consequences of this generalization will be taken up in § 6.4 below.

5.1.4. In § 5.1.2 and § 5.1.3, I have presented evidence which indicates that it must be possible to limit the upward range of application of both reordering transformations and feature-changing rules. In this section I will discuss three cases which suggest that

it is also necessary to be able to limit the downward range.

For a first example, let us redirect our attention to the English rule of Reflexivization. In § 4.1.6 above, I mentioned that in Lees and Klima (1963), the term "simplex sentence" is used to restrict the scope of application of this rule. The question which should now be raised is the following one: should both this notion and the notion of upward bounding be defined in the theory of grammar? Or should the former notion be defined as a conjunction of upward bounding and a new kind of bounding -- downward bounding? A rule is upward bounded if it cannot permute constituents into, or change features in, a higher clause, and, correspondingly, a rule would be downward bounded if it could not effect such changes in lower clauses.

It seems to me to be desirable to "decompose" the notion of simplex sentence into the two notions of upward and downward bounding, for the following reasons. Firstly, the arguments in the previous sections indicate that regardless what decision is made with respect to the English rule of Reflexivization, the notion of upward bounding must appear as an element of the theory of grammar. To characterize the difference between the English and the Japanese rules of Reflexivization, some auxiliary primitive term must be added to the theory -- either simplex sentence or downward bounding. If the former term is chosen, then the fact that the restrictions on the English rule are in part universal cannot be captured. For the fact that elements of higher clauses cannot be reflexivized in English is a

consequence of (5.77), since Reflexivization is a feature-changing rule. The only way to express the fact that the English rule is partly universal, within a theory which only contains the primitives upward bounding and simplex sentence is to complicate (5.77) in an ad hoc way, as has been done in (5.118).

(5.118) All feature-changing rules are either upward bounded or restricted to apply within a simplex sentence.

Since the notion of simplex sentence would be unanalyzed within such a theory, it would be impossible to capture the intuition that the English rule is identical to the Japanese rule (or to the Russian rule -- all three can be stated as in (5.98)), except for containing an additional restriction which is not stated on the latter two rules.²¹ So for the purposes of the present discussion, I will assume that the theory contains as primitives the notions of upward and downward bounding. This assumption will be modified in § 5.2 below.

The second example of a rule which requires the use of the notion of downward bounding is the Scrambling Rule, (3.48), which was discussed in § 3.1.2 above. As noted in the condition on (3.48), major elements in a Latin sentence can scramble, provided that they are in the same clause. This restriction on (3.48), the statement of which required quantifiers (cf. Ch. 3 footnote 7), can now be achieved by marking (3.48) as a rule which is upward and downward bounded.

The third case where downward bounding seems to be necessary, although not sufficient, is in connection with the rule of Serbo-Croatian Clitic Placement, (3.63), which was discussed in § 3.1.4 above. There I pointed out that clitics must be moved so that they follow the first constituent of the first sentence up -- thus the rule must be upward bounded. However, it is also necessary to stipulate that (3.63) be downward bounded, so that the clitics cannot be inserted after the first element of a sentential subject clause. In other words, the circled clitic in (5.119) must not be allowed to follow the path of the dotted arrow, but only that of the solid arrow.

(5.119)

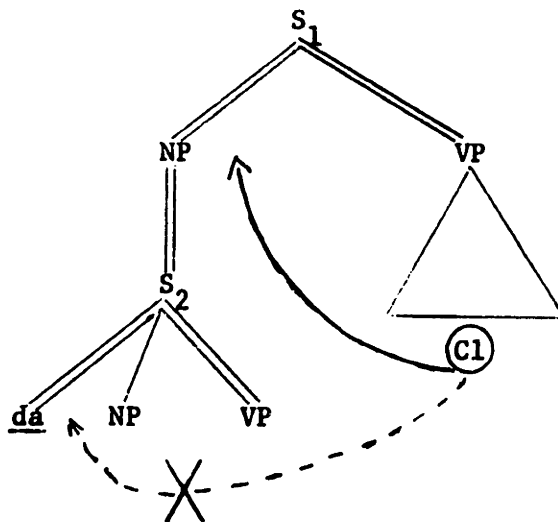

Such an incorrect positioning of a clitic can be avoided if (3.63) is marked as being downward bounded, in addition to being upward bounded.²²

The three cases I have just discussed indicate that an adequate theory of bounding must countenance both upward and downward bounding. At present, however, there is a puzzling redundancy, which

cries out for explanation: all downward bounded rules are upward bounded, but the converse is not true. That is, while there are rules whose scope extends indefinitely far down the tree from the triggering element or context, but does not extend upward, there are no rules whose scope extends indefinitely far up the tree, but not downward. I will present the first steps toward an explanation of this asymmetry in § 6.4 below.

5.2. Command

5.2.1.

5.2.1.0. In § 5.1, I discussed several problems which necessitated the addition to linguistic theory of some new mechanism, and to this end I proposed the particular device of bounding. In this section, I will show that Langacker's notion of command can account for all the facts adduced in support of bounding, and in addition, facts which cannot be accounted for with bounding. Furthermore, I will show that Klima's notion in construction with is too weak to account for all facts which can be handled with command.

5.2.1.1. Langacker defines command in a definition which is equivalent to that stated in (5.120) (cf. Langacker (1966), p. 11):

(5.120) Node A of a phrase marker commands node B if neither node dominates the other, and if node B is dominated by the first node S above A.

To give an example, in phrase-marker (5.121),

(5.121)

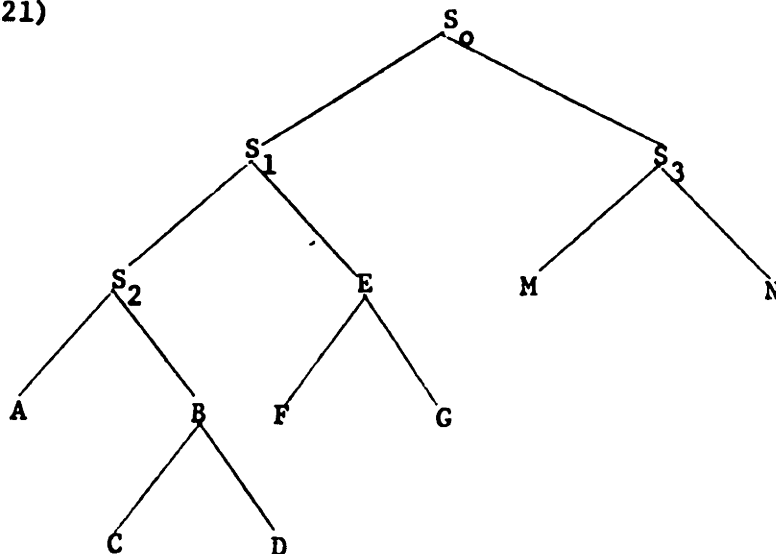

A commands and is commanded by B, C, and D; and C and D command each other. E, F, and G command S_2 , A, B, C and D. S_2 , F, and G command each other, as do S_2 and E. M and N command each other, and are commanded by only S_1 . Nodes A, B, C, D, E, F, G and S_2 neither command nor are commanded by M and N.

A moment's reflection will convince one that command can be used in place of upward bounding in all feature-changing rules. For instance, to say that Indefinite Incorporation, (5.71), is upward bounded is to say that the feature [+ Affective] cannot "broadcast" the feature [+ Indefinite] upwards across double lines in a phrase-marker. Rephrased in terms of command, the restriction would be that

the [+ Affective] element must command any [+ Indeterminate] element to which it adds the feature [+ Indefinite]. It is simple to replace the restriction of upward bounding for the other six feature-changing rules discussed in § 5.1.3.2: the rule of Finnish Nominative Introduction, (5.108) must have the restriction imposed on it that term 1 command term 3, rule (5.115b) must be restricted so that term 4 commands term 2, and the condition which must be imposed on the other five rules is that term 2 command term 4.

Furthermore, just as it could be predicted that all feature-changing rules are upward bounded, the conditions stated in the last paragraph can be derived automatically from (5.122), which is the analog to (5.77).

(5.122) Except for rules of pronominalization, in all feature-changing rules, elements to which features are added must be commanded by any non-variable terms appearing in the structural indices of the rule in question.

5.2.1.2. Langacker cites the rule of Indefinite Incorporation as an example of the usefulness of command, and on pp. 27-32, he discusses two examples of rules which move constituents and their relationship to his important notion of control. He does not consider rules such as Extrapolation, which the discussion in § 5.1 showed to be necessarily upward bounded. But once again, it is easy to

dispense with upward bounding as a device for preventing extraposed constituents from going too far. If the definition in (5.120) is extended in a natural way, so that the relation of command holds not only between one node and another, but may hold between one node and a sequence of nodes, if and only if the first node commands each of the nodes in ^{the} sequence, then instead of designating a rule such as Extrapolation, (4.126), as being upward bounded, we can impose the condition on it that the clause to be extraposed command the variable in the fourth term of its structural index. Moreover, the generalization expressed in (5.58), that all rules which adjoin a term to the right of a variable which occurs on the right end of a structural description are upward bounded, can be equally well expressed in terms of command, as in (5.123):

- (5.123) In all rules whose structural index is of the form ... A Y, and whose structural change specifies that A is to be adjoined to the right of Y, A must command Y.

Having stated this generalization in the theory of grammar, it is not necessary to attach any conditions to the rules of Extrapolation from NP, (1.10), Extrapolation, (4.126), and NP Shift, (5.57): (5.123) has the effect of constraining the structural changes of these rules the same way the conditions would. And it is evident that the operation of the upward bounded rule of Adverb Preposing, (5.67), can be correctly distinguished from that of the unbounded rule of Topicalization, (4.185),

if a condition that term 2 command term 1 is imposed upon the former rule, but not upon the latter.

Finally, note that all the cases presented in § 5.1.4 in support of downward bounding, which I originally believed not to be accountable for within a theory of grammar in which only command was available, can in fact be accounted for by stating two conditions in terms of command. That is, instead of ensuring that only elements of the same clause can be scrambled by designating the rule of Scrambling, (3.48), as being upward and downward bounded, this effect can be achieved by requiring that terms 2 and 3 of rule (3.48) command each other. This condition makes it impossible for the elements being permuted in (3.48) to be in different clauses: if A were a member of a clause which did not contain B, then A would not command B, and conversely. To specify that two nodes command each other is to specify that each is dominated by the first node S above the other, and because of the formal properties of trees,²³ these S nodes must be the same. That is, two nodes which command each other are in the same simplex sentence.

Although Langacker remarks in passing that it is possible to restrict the scope of a transformation by the use of double command conditions, he gives no examples where this device is necessary. It should be clear that the other two examples cited in § 5.1.4, the English rule of Reflexivization and the rule of Serbo-Croatian Clitic Placement, can also be formulated in terms of double command.

Thus a theory in which command is an available primitive is at least as powerful as a theory which provides upward and downward bounding. Before showing that the former theory is stronger than the latter in a crucial way, I will digress to show that Klima's notion in construction with is not strong enough.

5.2.2. Klima's notion is defined as in (5.124) (cf. Klima (1964), p. 297):

(5.124) Node A of a phrase-marker is in construction with node B if B is dominated by the node which immediately dominates A.

That this relation is stronger than command can be seen from (5.121), where E, F, and G command S_2 , A, B, C and D, but where only E is in construction with these latter five nodes. Klima proposes to constrain the operation of rule (5.71) by imposing on it the condition that the [+ Affective] element be in construction with the [+ Indeterminate] element which is to be changed. That this condition is too strong can be seen from (5.125a), which (5.71) must be able to convert to (5.125b).

- (5.125) a. That Jack sometimes slept is impossible.
 b. That Jack ever slept is impossible.
 c. * That Jack ever slept is possible.

The ungrammaticality of (5.125c) shows that it is the negative prefix im- that contains the feature [+ Affective] and triggers the change.

But the structure which Klima would assign to (5.125) (cf., e.g., op. cit. p. 298, fig. 4) is that shown in (5.126),

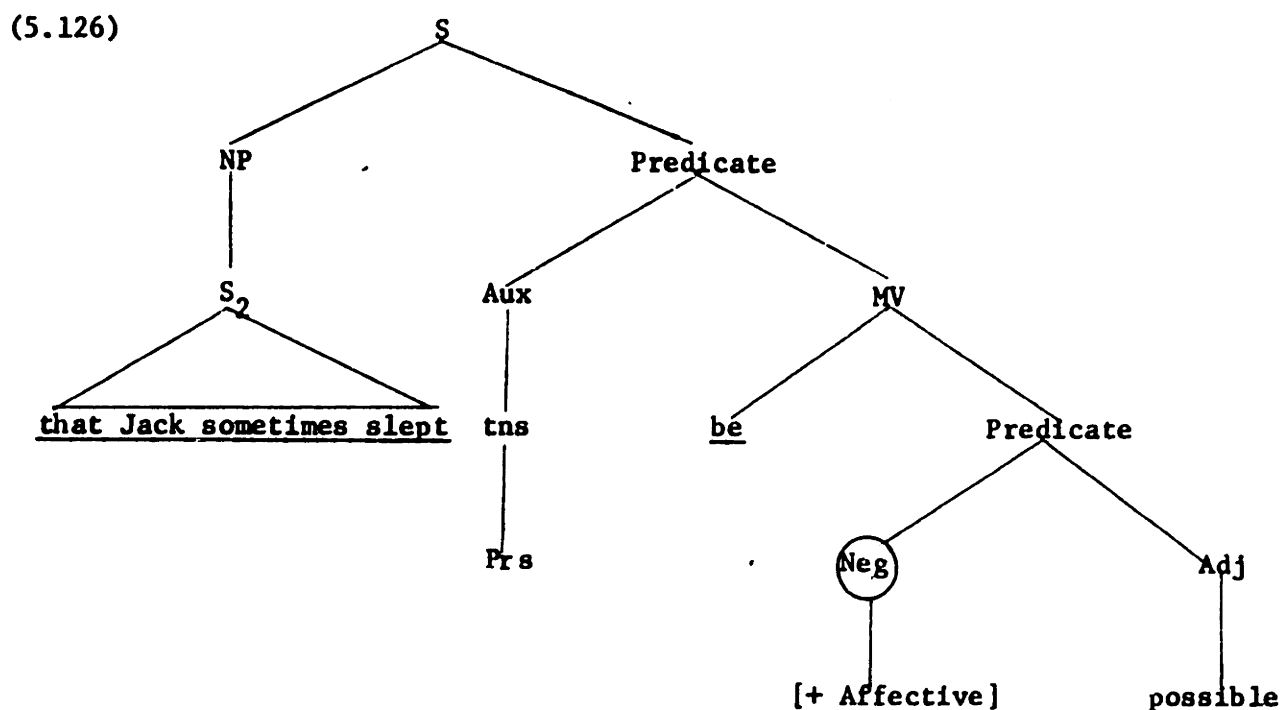

and in this structure, the circled node *Neg*, which carries the feature [+ Affective], is not in construction with the occurrence of sometimes in the subject clause, although the latter word is commanded by the circled node. Thus with respect to rule (5.71) there is at least one structure for which Klima's notion produces the wrong results, and Langacker's notion the correct ones. Langacker's notion must therefore be chosen even if only the facts connected with rule (5.71) are taken into consideration.

But there are even more important respects in which the notion of command is superior to the notion in construction with. As

I showed in § 5.1.3.2, all feature-changing rules except rules of pronominalization are upward bounded. This extremely powerful generalization, to which I know of no counterexamples, can be restated in terms of the notion of command, as was done in (5.122). But this generalization cannot be reformulated in terms of the notion in construction with. (5.127), in which I have stated such a reformulation, is too strong.

(5.127) In all feature-changing rules, non-variable terms are in construction with the terms to which the features are added.

To see that (5.127) is too strong, consider (5.128), the structure of (5.129a).

(5.128)

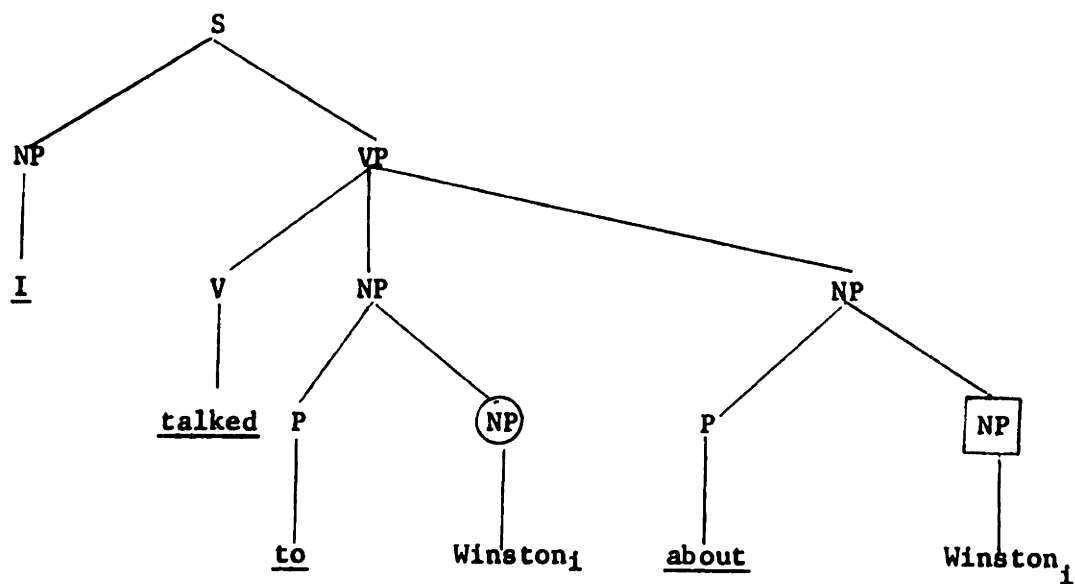

(5.129) a. * I talked to Winston_i about $\left\{ \begin{array}{l} \text{Winston}_i \\ \text{him}_i \end{array} \right\}$.

b. I talked to Winston_i about himself.

Since the English rule of Reflexivization is a feature-changing rule,²⁴ and since the circled NP node in (5.128) is not in construction with the boxed NP node, generalization (5.127) would incorrectly prevent Reflexivization from converting (5.129a) into (5.129b). But Reflexivization is obligatory in such structures as (5.128), so (5.127) must be wrong.

Another rule which provides counterevidence to (5.127) is the rule for Sequence of Tenses, (5.115). String (5.130a) must be converted into (5.130b) by this rule,

(5.130) a. * That the sun is out was obvious.

b. That the sun was out was obvious.

but since the structure of (5.130a) is that shown in (5.131),

(5.131)

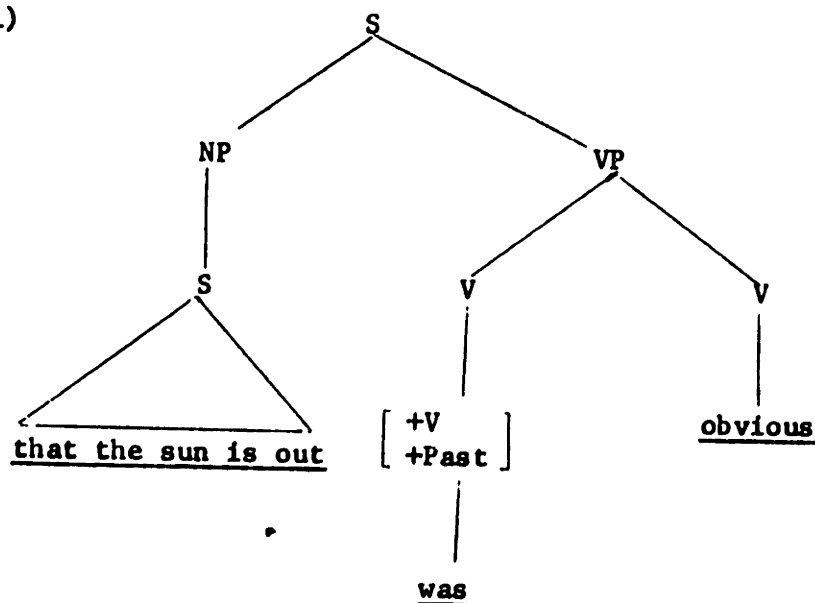

where the tensed verb was is not in construction with the verb is in the sentential subject,²⁵ the generalization in (5.127) would not allow the change to take place.

The third argument for choosing command over in construction with is is that while the important notion of simplex sentence can be captured by the use of two conditions making use of command, this cannot be done with the notion in construction with. To say that two nodes command each other is to say that they are elements of the same simplex sentence, but to say that they are in construction with each other is to say that they are sisters.

The above arguments indicate that the notion of command cannot be replaced by the notion in construction with, but of course they do not show that the latter notion cannot supplement the former in linguistic theory. To account for the facts in § 5.1 and § 5.2.3, the notion of command, or its equivalent, must be defined in linguistic theory. While the notion in construction with is is not the equivalent of the notion of command, it is possible that phenomena will come to light whose analysis will necessitate the inclusion within linguistic theory of the former notion. At present, no such facts are known.

5.2.3.

5.2.3.1. In this section I will discuss two problems which can be solved within a theory in which command is defined, but not within one in which only bounding is available.

Consider first the following facts about identity:

(5.132) John scratched his arm and $\left. \begin{array}{l} \text{so did Mary} \\ \text{Mary did (so) too} \end{array} \right\}$.

The second clauses of the sentences in (5.132) are ambiguous - they could be derived from the structure underlying (5.133a) or the one underlying (5.133b).

- (5.133) a. Mary scratched her arm (too).
 b. Mary scratched John's arm (too).

Thus it appears that linguistic identity must be defined in such a way that the difference between his arm in the first clause of (5.132) and her arm in (5.133a) is "disregarded." However, it is not the case that all differences between pronouns can be disregarded: (5.134a) cannot be transformed into (5.134b).

- (5.134) a. John scratched his arm and the boy who knew
 Mary scratched her arm.
 b. John scratched his arm and the boy who Mary
 knew did so too.

These facts can be accounted for if the following definition of identity is adopted in the theory of grammar:²⁶

- (5.135) Constituents are identical if they have the same constituent structure and are identical morpheme-for-morpheme, or if they differ only as to pronouns, where the pronouns in each of the identical constituents are commanded by antecedents in the non-identical portions of the phrase-marker.

Thus in (5.136), which underlies one reading of (5.132), the circled NP's John and Mary command the circled pronouns his and her, so deletion is possible under the definition given in (5.135).

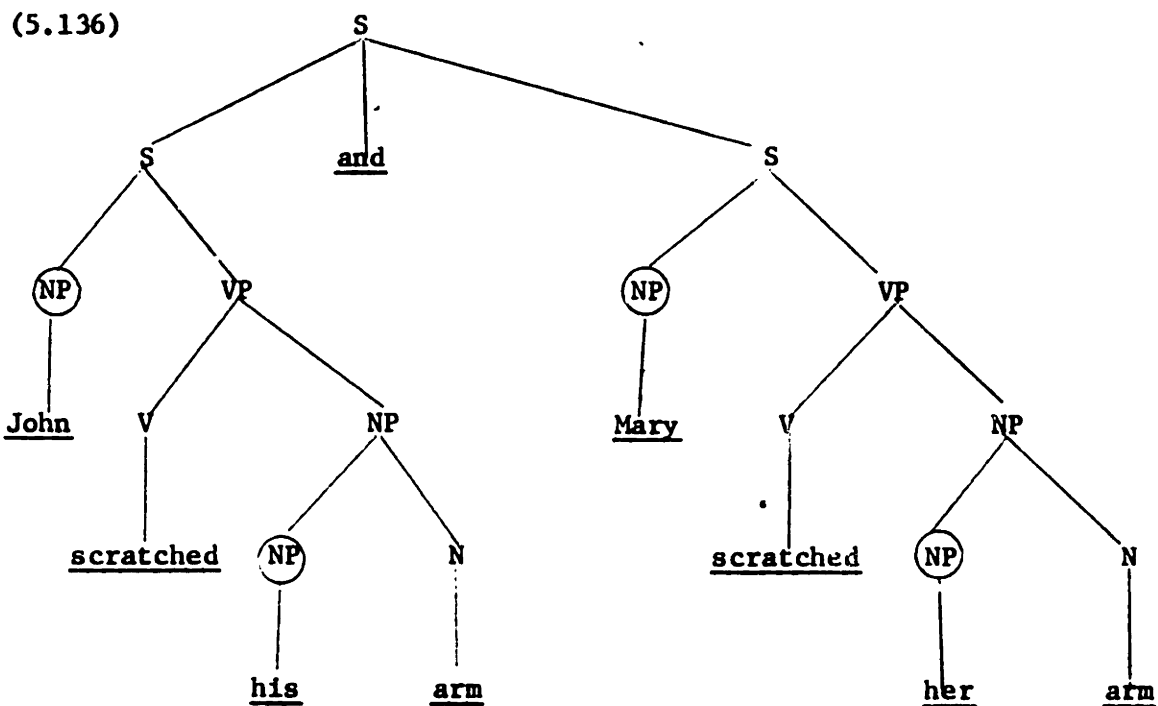

On the other hand, in (5.137), which underlies (5.134), John commands his, but the boxed NP Mary does not command its pronoun her, so (5.135) will not let the deletion go through.

(5.137)

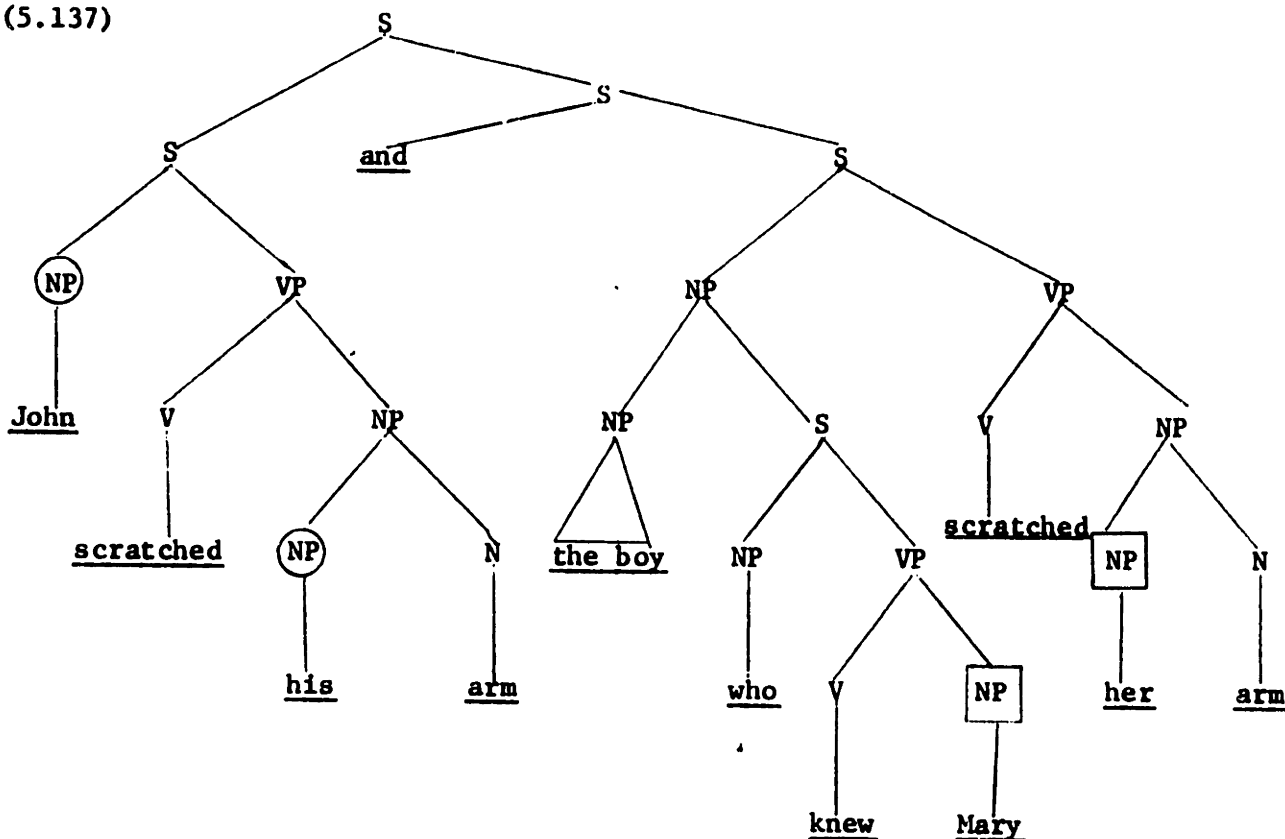

The same facts obtain for right-to-left pronominalization:

(5.138a) can be derived from (5.138b) or (5.138c), because the circled noun phrases command the pronouns which refer to them.²⁷

- (5.138) a. That the fuzz wanted him worried John, but it didn't worry Mary.
- b. That the fuzz wanted (him) worried (John), but that the fuzz wanted (her) didn't worry (Mary).
- c. That the fuzz wanted (him) worried (John) but that the fuzz wanted John didn't worry Mary.

Note, however, that just as (5.137) cannot be converted into (5.134b), (5.139) cannot be converted into (5.140), for while the circled NP John in (5.139) commands its circled pronoun, him, the boxed NP Mary does not command its boxed pronoun, her.

(5.139)

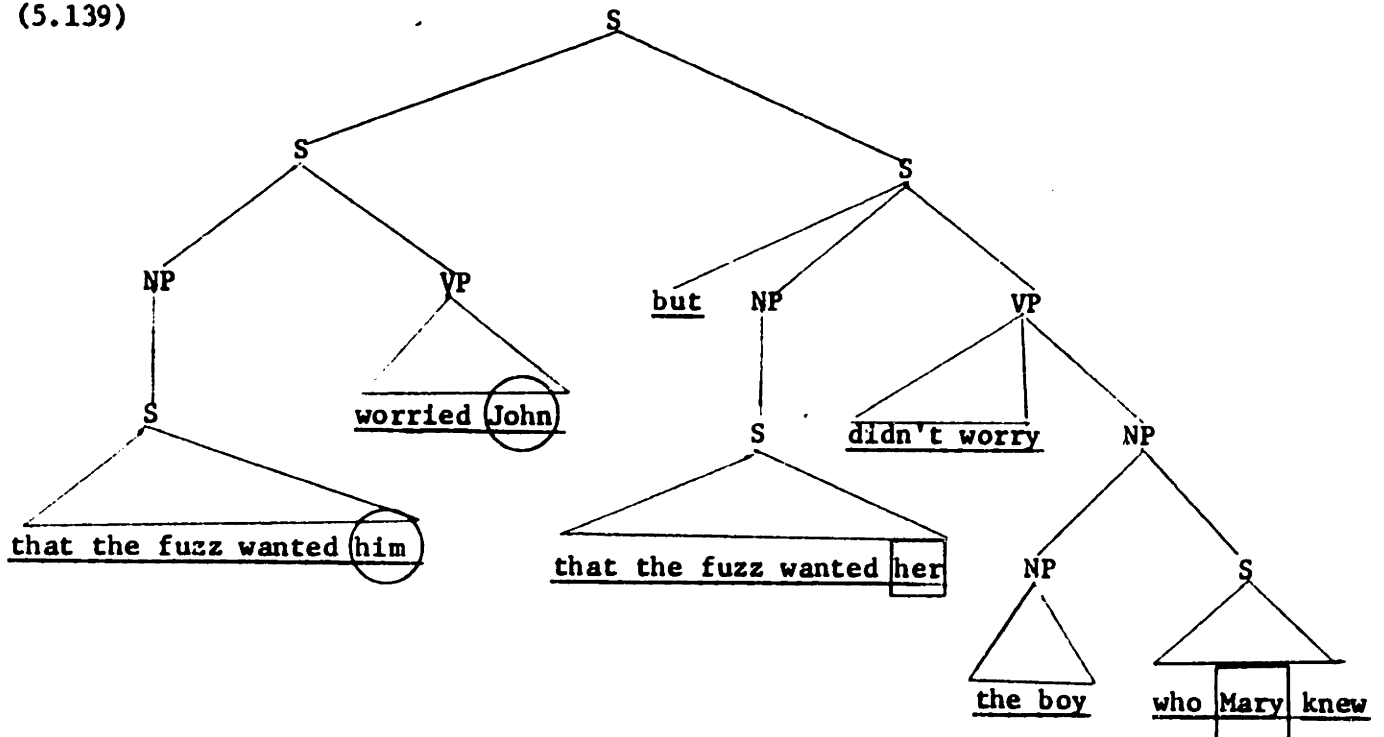

(5.140) That the police wanted him worried John, but it didn't worry the boy who Mary knew.

I know of no reason to assume that the relation of identity must be defined in language-particular terms, so some revised version of (5.135) will appear in the theory of grammar. And since (5.135) makes crucial use of the notion of command, this definition provides strong support for the hypothesis that command is a primitive term of the theory of

grammar, and not the notion of bounding. For notice that bounding was devised to restrict the scope of a process -- it has to do with the structural changes of rules which move constituents or features-- and that here some static relation is necessary, in order for the conditions under which a process can take place to be established. It is because of this difference in function that bounding is intrinsically unsuited to the task of defining linguistic identity.

5.2.3.2. It is for the same reason that command, but not bounding, can handle the following facts. There is a well-known restriction that excludes negatives in than-clauses.²⁸ Somehow, all the sentences in (5.141) must be excluded, while the ones in (5.142) must be allowed.

- (5.141) a. * John is prouder of having gone than nobody expected me to believe he would be.
- b. *than John didn't expect me to believe ...
- c. *than John expected nobody to believe ...
- d. *than John expected me not to believe ...
- e. *than John expected me to believe not all my friends were.
- f. *than John expected me to believe that he wasn't.
- (5.142) a. John is prouder of having gone than people who don't know him would expect me to believe he would be.

- b.than Sally expected Joan to believe
that the man who didn't shave would be.
- c.than I expected you to believe he would
be of not having fallen asleep.

In other words, to exclude all negatives from than- clauses would be to incorrectly exclude the sentences in (5.142). The difference between (5.141) and (5.142) can be expressed naturally if conditions on rules can be stated which make use of command. To exclude the sentences in (5.141) it is sufficient to say "The feature [+negative] may not command the compared element in the than-clause."²⁹ Since the negative elements in (5.142a) and (5.142b) are in relative clauses, they will command only the other elements of these clauses. And the not of (5.142c) is one clause lower than the compared adjective, proud, so all the sentences of (5.142) will be generated. But in each of the sentences in (5.141), proud is commanded by a negative element, so all will be blocked by the condition stated above.

Once again, since what is required here is the statement of a static precondition for the operation of a rule, these facts cannot be accounted for with bounding. Therefore, in conjunction with the facts about identity discussed above, and the rules which Langacker discusses on pp. 27-33 (op. cit.), which require Langacker's principle of control for their correct application (this principle is also not susceptible of reformulation in terms of bounding), these facts about comparatives seem to me to make the choice between bounding and command

obvious: *command*, as defined in (5.120), is a part of the theory of grammar, while *bounding* is not.

5.3. Pronominalization

5.3.0. Thus far, in this work, I have discussed constraints on variables in reordering transformations (in Chapter 4 and in §§ 5.1.1 - 5.1.2) and constraints on variables in feature-changing rules (in § 5.1.3 and § 5.2). There is another kind of process whose scope is unbounded, the statements of rules for which also make crucial use of variables³⁰ -- pronominalization. In § 5.3.1, I will discuss several kinds of pronominalization and show that not all transformations which delete under identity make crucial use of variables. In § 5.3.2, I will argue against Langacker's contention (cf. Langacker (op. cit.)) that constraints on variables in rules of pronominalization can be stated in terms of *command*. In § 5.3.3, I will discuss four rules of pronominalization, which appear, at least at the present state of knowledge, to have to be stated as distinct processes, showing that they obey the same constraint which the rule that introduces the definite pronouns is subject to. Finally, in § 5.3.4, I will show that they obey no other constraint thus far discussed, and discuss the possibility that the constraint stated in § 5.3.2 is universal.

5.3.1. The most natural definition of pronominalization is deletion under identity. This definition covers a number of operations,

which, though unbounded in scope, do not made crucial use of variables and will not be dealt with here. For instance, the rules which convert the sentences in (5.143) into the corresponding ones in (5.144) must be formulated as schemata, and I will not discuss such rules here.

- (5.143) a. Tom knows it and Dick knows it and Harry knows it.
- b. Tom washed the car, and Dick waxed the car, and Harry polished the car.
- c. Tom ate, and Dick drank, and Harry sang.
- d. Tom ordered bacon, and Dick ordered lettuce, and Harry ordered tomatoes.
- (5.144) a. Tom, Dick, and Harry know it.
- b. Tom washed, and Dick waxed, and Harry polished the car.
- c. Tom, Dick, and Harry ate, drank, and sang, respectively.
- d. Tom ordered bacon, and Dick lettuce, and Harry tomatoes.

Although rules like Gapping, the rule which converts (5.143d) into (5.144d),³¹ can apply to delete the verb of an indefinitely large number of consecutive conjoined sentences, it cannot be formulated with a variable, for otherwise it would convert (5.145a) into the ungrammatical (5.145b).

- (5.145) a. Tom ordered bacon, and Dick ordered lettuce,
and I think that Harry ordered tomatoes.
- b. * Tom ordered bacon, and Dick lettuce, and I
think that Harry tomatoes.

There are also a number of rules which reduce identical elements if these occur in designated constructions. For instance, (5.146a), may be converted into (5.146b) by the operation of one such rule.

- (5.146) a. Joe is taller than Mary is.
- b. Joe is taller than Mary.

However, this rule must not be stated in a way that makes crucial use of variables, or else (5.147a) would be converted into the ungrammatical (5.147b).

- (5.147) a. Joe is taller than I think Mary is.
- b. * Joe is taller than I think Mary.

I will therefore restrict my attention to those rules of pronominalization whose structural index is like that shown in (5.148a), and whose structural change like one of the versions of (5.148b) or (5.148c)

- (5.148)³² a. ...A₁...X...A₂... Condition: A₁ = A₂
- b. ...A₁...X... $\left\{ \begin{array}{c} [A_2] \\ [+Pro] \\ \emptyset \end{array} \right\}$...
- c. ... $\left\{ \begin{array}{c} [A_1] \\ [+Pro] \\ \emptyset \end{array} \right\}$...X...A₂...

The superficial similarity of (5.148) to a feature-changing rule should not be deceptive. For the feature [+Pro] is not a feature like the [+Indefinite] of (5.71) or the [+Nom] of (5.108) -- it is an instruction to delete all or part of the constituents of the node to which it is attached. So if some rule of the form of (5.148) converts (5.149a) into (5.149b), by adding the feature [+Pro] to the circled NP,

(5.149) a.

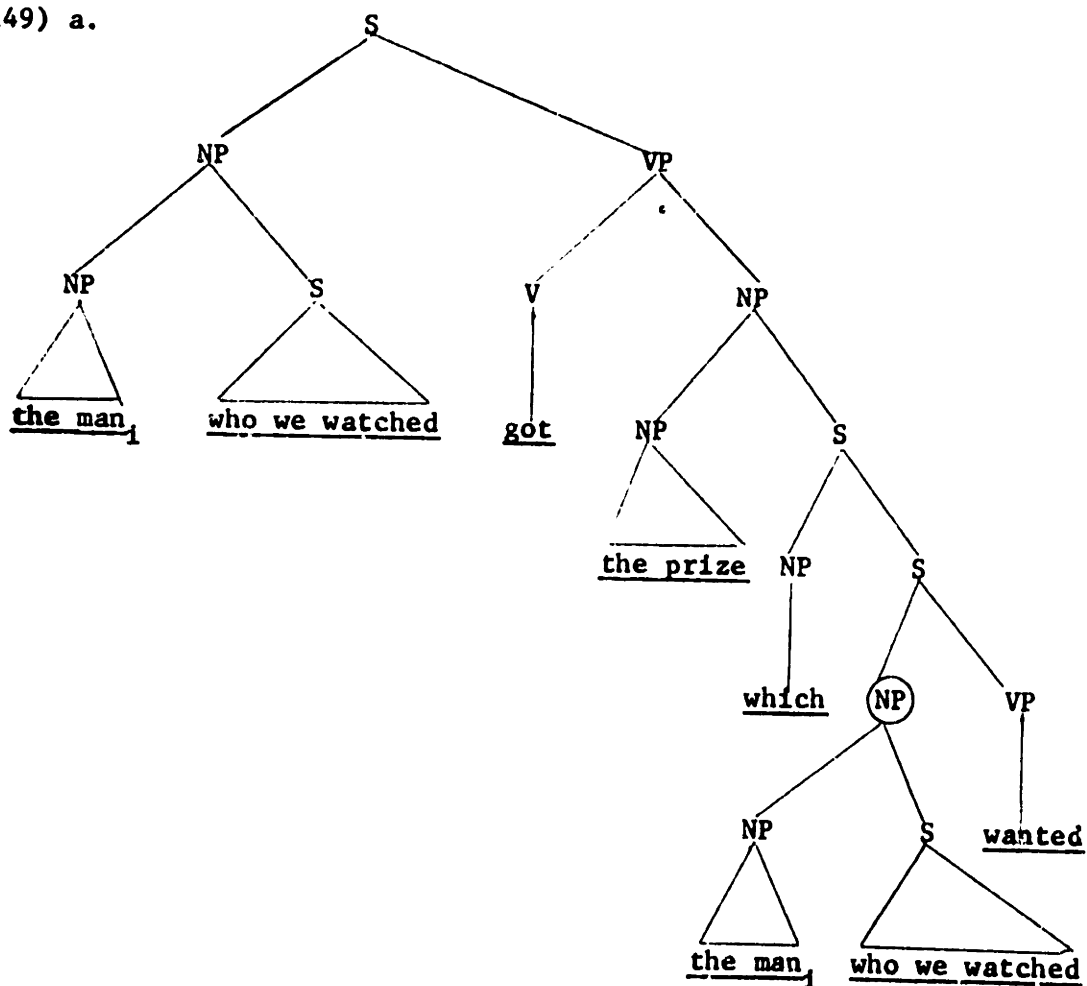

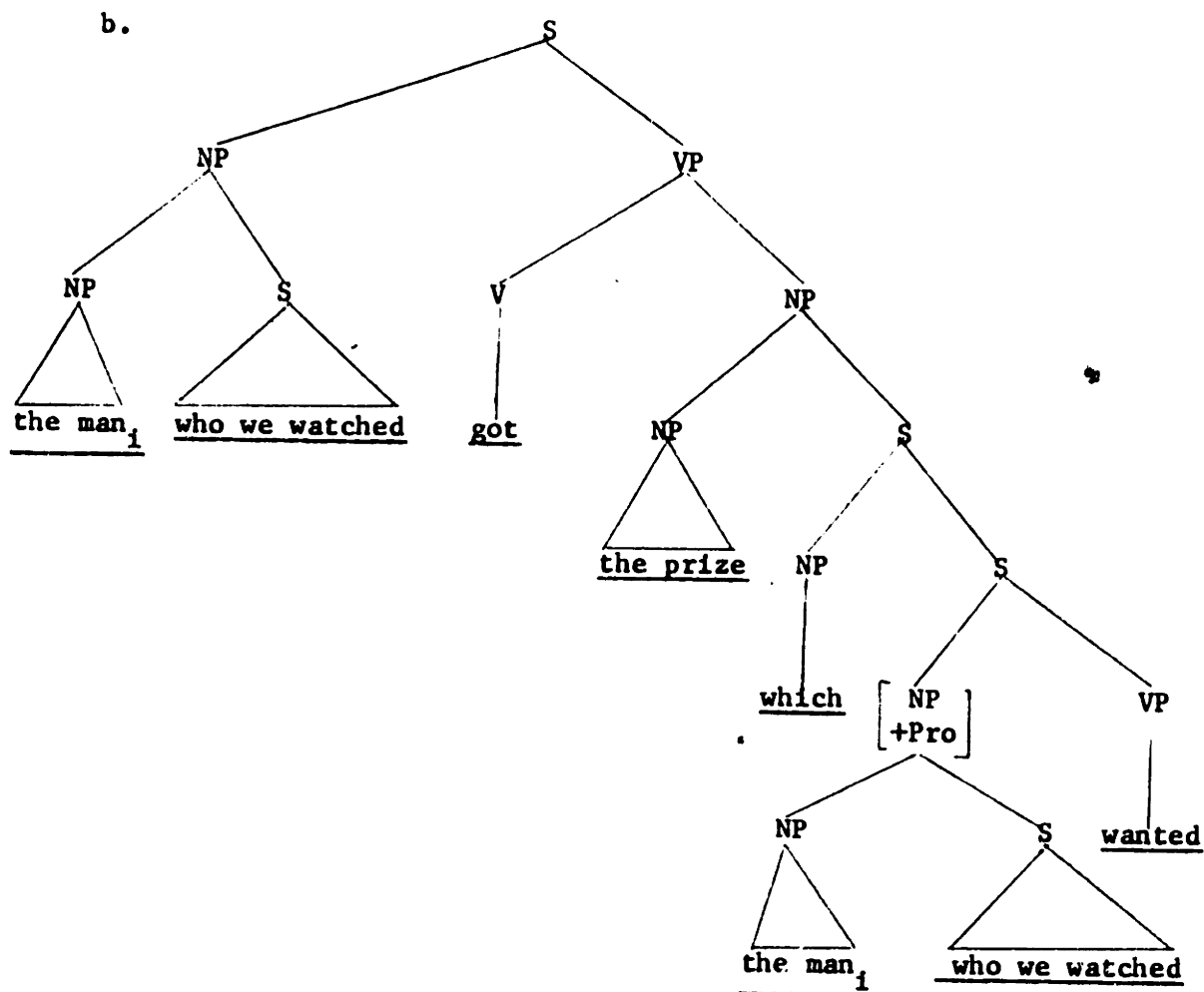

some later rule or convention must reduce all of the NP so marked to the single word he.³³ In other cases, the deletion is complete, as in the conversion of (5.150a) to (5.150b).

(5.150) a. Mike will sing if you will sing.

b. Mike will sing if you will.

Furthermore, rules of pronominalization are not upward bounded, as was shown with reference to the sentences in (5.80), and they will be shown, in § 5.3.3, not to be subject to the constraints of Chapter 4,

which appear to constrain all other feature-changing rules (cf. § 6.4 below).

5.3.2. Most rules of pronominalization produce paradigms like the one in (5.151).

- (5.151) a. Jim_i will go if he_i feels good.
 b. * He_i will go if Jim_i feels good.
 c. If Jim_i feels good, he_i will go.
 d. If he_i feels good, Jim_i will go.

I have argued elsewhere (cf. Ross (1967a)), that the constraint which is operative here is the one stated in (5.152):

(5.152) Condition on backward pronominalization

If one element precedes another, the second can only pronominalize the first if the first is dominated by a subordinate clause which does not dominate the second.³⁴

There are two instances of right-to-left, or "backward" pronominalization in (5.151) - (5.151b) and (5.151d). Since the if-clause is a subordinate clause, the latter is grammatical, while the former is not.

Langacker proposes a different condition on backward pronominalization (cf. op. cit. pp. 11-22), the gist of which is stated in (5.153).

- (5.153) One noun phrase may pronominalize another unless the first both precedes the second and is commanded by it.

These conditions are almost identical, but not quite. To see this, consider the two sentences of (5.154) (these are the sentences numbered (72) and (73), respectively, in Langacker (op. cit.)).

(5.154) a. I gave the book to Harvey₁ because he₁ asked me to.

b. * I gave the book to him₁ because Harvey₁ asked me to.

Langacker derives (5.154a) from the intermediate structure shown in (5.155):

(5.155)

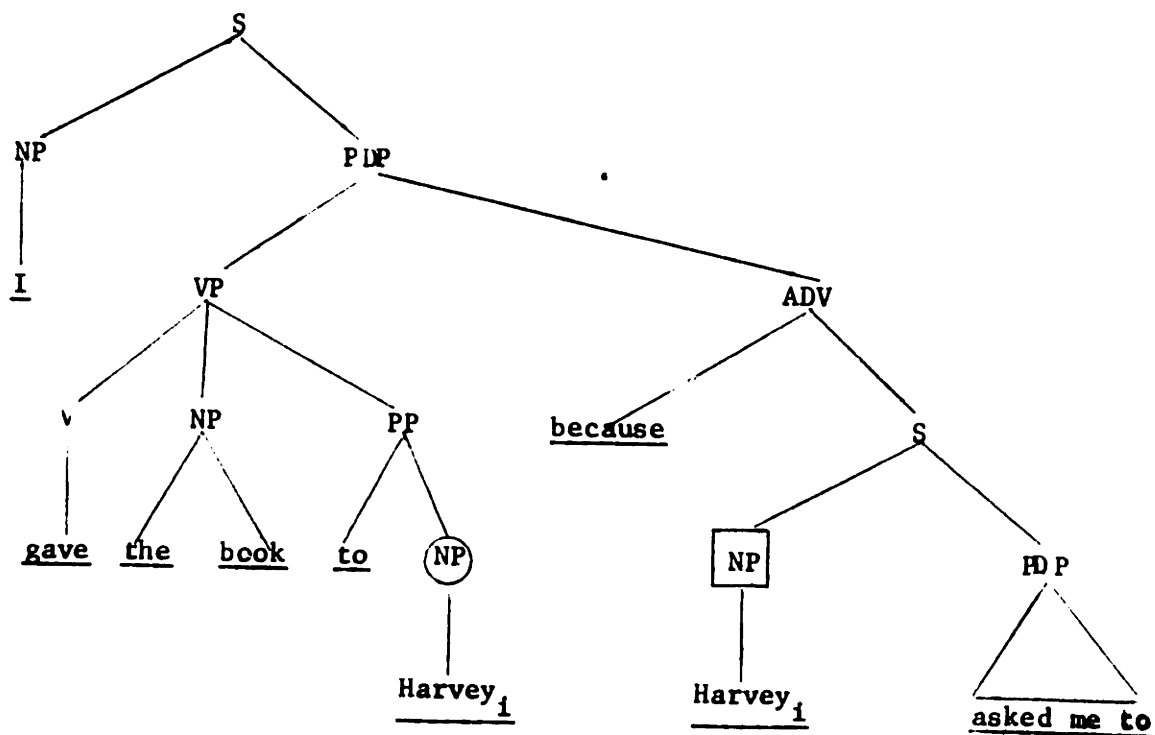

Since the circled NP in this structure both precedes and commands the boxed NP, the condition on pronominalization stated in (5.153) will suffice to prevent (5.155) from being converted to (5.154b).

But this explanation of the ungrammaticality of (5.154b) is only as good as the constituent structure on which it depends, so let us inquire as to the adequacy of the representation in (5.155).

In all traditional accounts, what would be said about (5.154a) is that it contains two clauses, the main clause being I gave the book to Harvey, and the subordinate clause being because he asked me to. Such a parsing would yield some structure like that shown in (5.156).

(5.156)

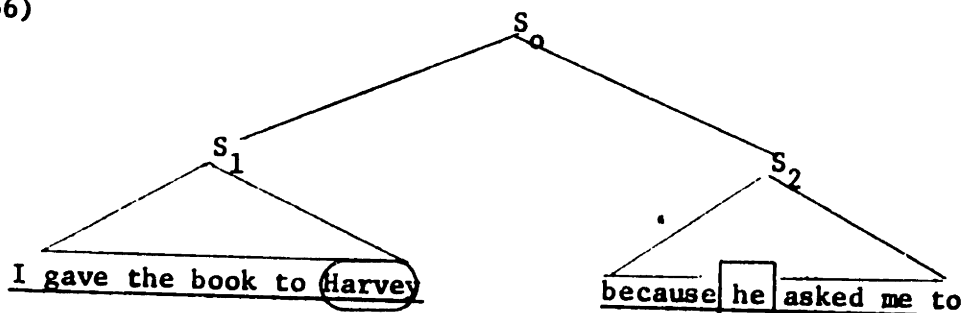

This structure is surely in far better accord with intuitions about the constituency of (5.154a) than is (5.155): the latter makes the counterintuitive claims that the major break in (5.154a) occurs after the pronoun I, and that I gave the book to Harvey is not a constituent. But Langacker's condition on pronominalization, (5.153), is not strong enough to block (5.154b), if the structure underlying it is like (5.156), rather than like (5.155). For while the circled NP in (5.156) precedes the boxed NP, it is not commanded by it, and (5.153) blocks pronominalization only if both of these conditions obtain.

There is another reason to believe (5.156) to be correct, and (5.155) incorrect. In Langacker (op. cit. footnote 13), Langacker discusses the three sentences of (5.157).

- (5.157) a. That I might want to leave never occurred to Harvey because he is insensitive to other people's desires.
- b. It never occurred to Harvey that I might want to leave because he is insensitive to other people's desires.
- c. * It never occurred to Harvey because he is insensitive to other people's desires that I might want to leave.

Langacker correctly concludes that the structure underlying (5.157a) is more nearly basic than the one underlying (5.157b), but he proposes to derive both from (5.158).

(5.158)

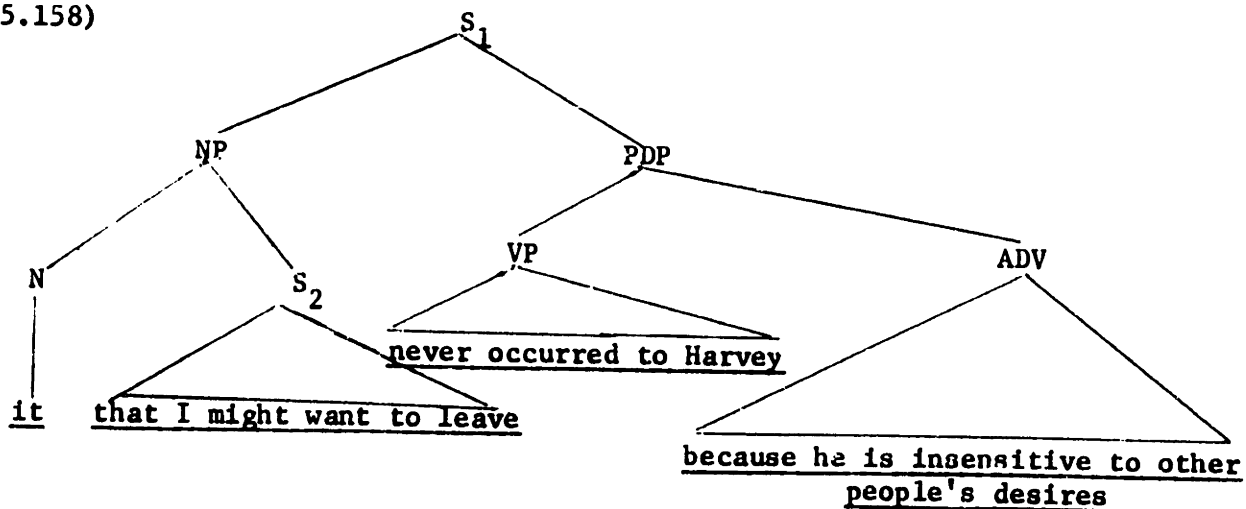

Having assumed such a structure, he is forced to conclude that the rule of Extrapolation must be formulated to permute S_2 around VP, and not around a variable, to the end of S_1 . However, if Extrapolation is stated in this restrictive manner, it will be necessary to state in addition another rule, so that sentences like those in (5.159) can be derived,

- (5.159) a. I figured it out that she was lying.
 b. I explained it to Bill that she was lying.
 c. I took it for granted that she was lying.
 d. I regret it exceedingly that she was lying.

for here, the extraposed clause does not move over a VP.

Since it is clearly wrong to treat (5.157b) and the sentences of (5.159) as being produced by different processes, another solution to the problem of excluding (5.157c) must be sought. The most satisfactory analysis, in my view, is to derive (5.157b) from (5.160).

(5.160)

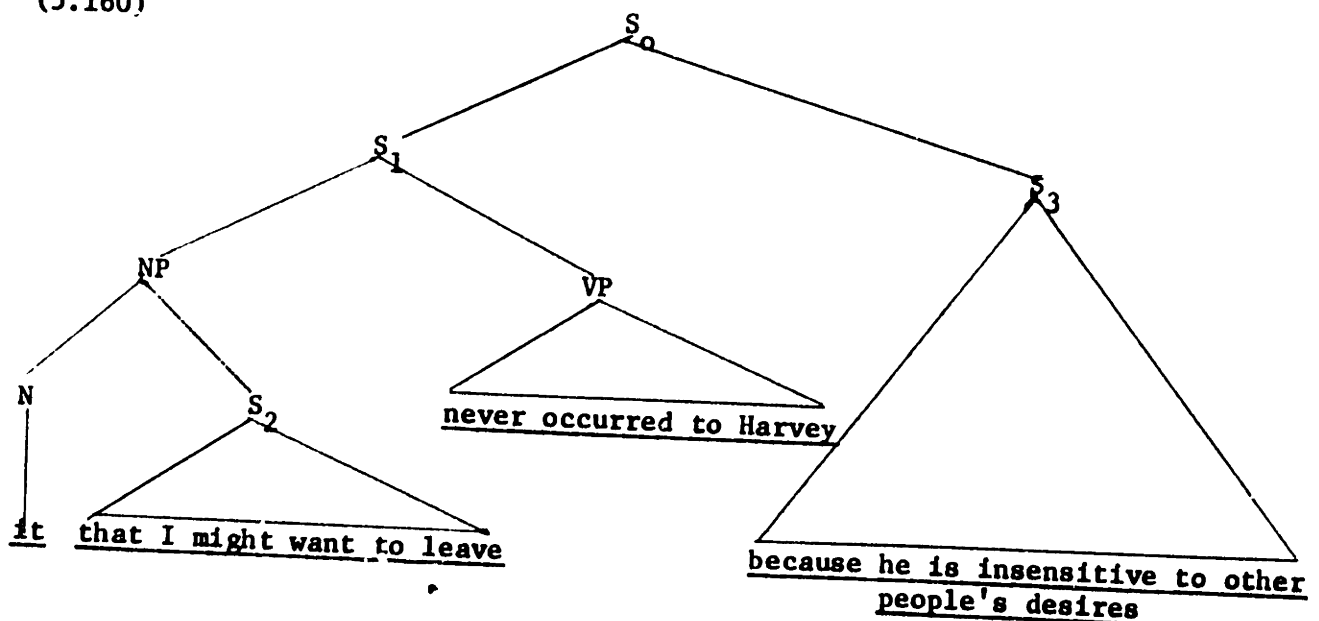

The clause to be extraposed, S_2 , must command any string over which it is permuted (by the generalization stated in (5.123)), and since S_2 commands VP_1 in (5.160), and does not command S_3 , (5.157b) can be generated when Extrapolation applies to (5.160), but not (5.157c). Therefore, since (5.160) produces none of the d.c.s. inadequacies noted in connection with (5.155), and since it requires no unpalatable proliferation of rules of extraposition, I conclude that it, and not (5.158), represents the correct structure of (5.157a), and that similarly (5.156) and not (5.155), the correct structure of (5.154a).

If (5.156) and (5.160) are correct structures, then backward pronominalization cannot be blocked by Langacker's condition, (5.153), although it can be blocked by (5.152). ' It is for this reason that I have rejected condition (5.153) in favor of (5.152), but it should be noted that there are a number of interesting facts having to do with varying degrees of naturalness in pronominalization (cf. Langacker (op. cit.) pp. 16-18), which can be accounted for with the former condition on pronominalization but not with the latter. I therefore regard the matter as anything but closed, and my assumption below that (5.152) is correct should be treated as being only provisional.³⁵

5.3.3.

5.3.3.0. Below, I will discuss briefly four kinds of pronominalization which produce paradigms like the one in (5.146). It may turn out that they only appear dissimilar and can really be shown to be subcases of

the same rule, but I will not attempt such a proof here. I will merely show that they are similar to the rule which produces definite pronouns in that all are subject to the condition stated in (5.152), and that none are subject to the constraints of Chapter 4 or § 5.1.3.

5.3.3.1. While the rule which produces the definite pronouns of (5.151) requires identity of reference, the rule which inserts the pronoun one does not. That this rule is subject to (5.152) can be seen from the sentences of (5.161):

- (5.161) a. He'll bring me a hotdog if he sees one.
 b. * He'll bring me one if he sees a hotdog.
 c. If he sees a hotdog, he'll bring me one.
 d. If he sees one, he'll bring me a hotdog.

Sentences like those in (5.162) are obligatorily converted into the corresponding sentences in (5.163), under conditions which need not concern us here.

- (5.162) a. * Seven more soldiers came in after ten ones had left.
 b. * Seven more ones came in after ten soldiers had left.
 c. * After ten soldiers had left, seven more ones came in.
 d. * After ten ones had left, seven more soldiers came in.

- (5.163) a. Seven more soldiers came in after ten had left.
- b. * Seven more came in after ten soldiers had left.
- c. After ten soldiers had left, seven more came in.
- d. After ten had left, seven more soldiers came in.

5.3.3.2. The rule of S Deletion, which deletes a sentence which is a sister of the abstract pronoun it, if this sentence is identical to some other sentence in the phrase-marker, is also subject to condition (5.152), as (5.164) shows.³⁶

- (5.164) a. Harry believes that Sally is innocent, although noone else believes it.
- b. * Harry believes it, although noone else believes that Sally is innocent.
- c. Although noone else believes that Sally is innocent, Harry believes it.
- d. Although noone else believes it, Harry believes that Sally is innocent.

If sentence (5.165) is derived from a structure like that shown in (5.166), as I will argue is correct, in Lakoff and Ross (in preparation a),

(5.165) Webster touched a sword.

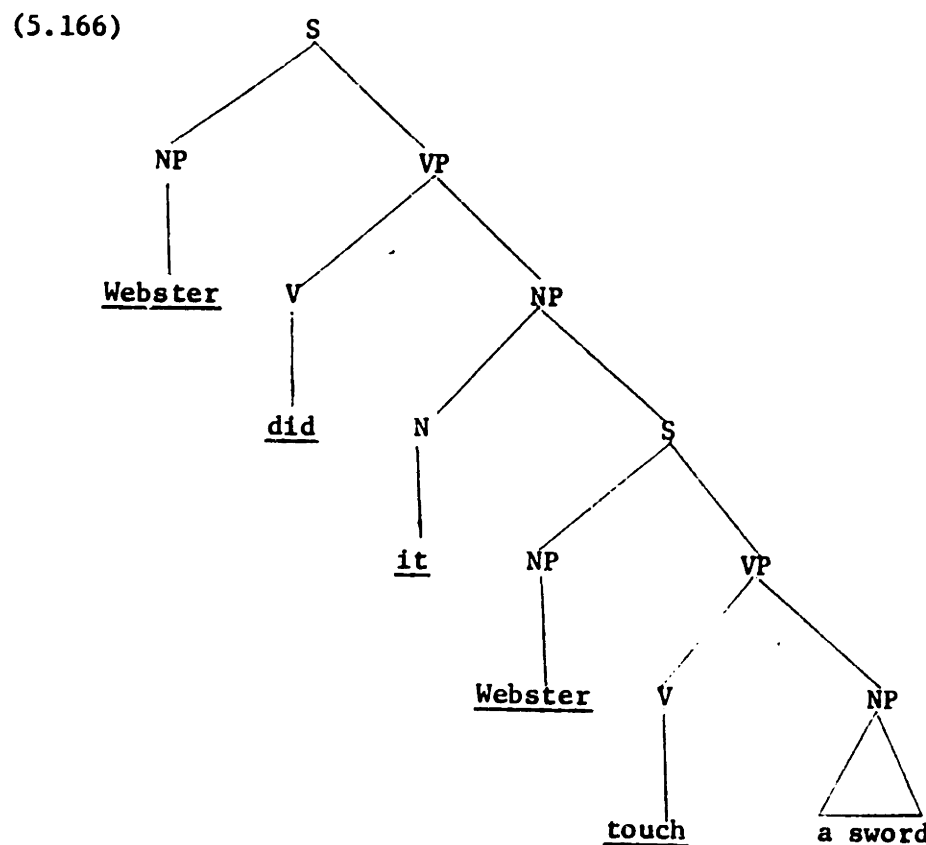

then the sentences of (5.167) can be derived as a special case of S Deletion.

- (5.167) a. Webster touched a sword after Henry had done it.
- b. * Webster did it after Henry had touched a sword.
- c. After Henry had touched a sword, Webster did it.

- d. After Henry had done it, Webster touched a sword.

If the analysis implicit in (5.166) cannot be maintained, then some additional rule of pronominalization, which replaces verb phrases having the feature [- Stative] with do it, will have to be formulated to account for these cases. Which analysis is correct is not my concern here.

5.3.3.3. There is another rule which pronominalizes sentences under identity, replacing them with the morpheme so. It may eventually prove to be possible to collapse this rule with the rule of S Deletion, although sentences like those in (5.168) make this seem unlikely.

(5.168) a. Did the Mets win? If $\left. \begin{array}{l} \text{so} \\ *it \end{array} \right\}$, I've lost \$500,000.

b. The doctors say that she's coming along well, but it didn't seem $\left. \begin{array}{l} \text{so} \\ *it \end{array} \right\}$ to me.

Whether So Insertion is the same rule as S Deletion or not, it is subject to (5.152), as the sentences in (5.169) show.

- (5.169) a. Harry thinks that Sally is innocent, although noone else thinks so.
- b. * Harry thinks so, although noone else thinks that Sally is innocent.

- c. Although noone else thinks that Sally is innocent, Harry thinks so.
- d. Although noone else thinks so, Harry thinks that Sally is innocent.

Once again, if the analysis implicit in (5.166) is correct, the pro-VP do so³⁷ can be generated as a special case of So Insertion. If not, a special rule inserting these forms must be added to the grammar. This rule will also be subject to (5.152), as (5.170) shows.

- (5.170)
- a. Webster touched a sword after Henry had done so.
 - b. * Webster did so after Henry had touched a sword.
 - c. After Henry had touched a sword, Webster did so.
 - d. After Henry had done so, Webster touched a sword.

5.3.3.4. The fourth type of pronominalization is the rule which converts sentences like those in (5.171) to the corresponding sentences of (5.172)

- (5.171) I'll work on it if $\left. \begin{array}{l} \text{I can work on it} \\ \text{you work on it} \\ \text{noone else has worked on it} \\ \text{Sam will be working on it} \end{array} \right\}$.
- (5.172) I'll work on it is $\left. \begin{array}{l} \text{I can} \\ \text{you do} \\ \text{noone else had} \\ \text{Sam will be too} \end{array} \right\}$.

In past generative treatments, this rule would have been formulated in such a way that it deleted a verb phrase under identity. In Lakoff and Ross (in preparation a) (cf. also Ross (1967b)), I will propose a reanalysis of the auxiliary system under which this rule will become a special case of So Insertion, with an additional rule deleting the pro-sentence so when it follows an auxiliary verb. But whichever of the analyses is correct, the rule is subject to (5.152), as the sentences of (5.173) show.

- (5.173) a. I'll work on it if I can.
 b. * I will if I can work on it.
 c. If I can work on it, I will.
 d. If I can, I will work on it.

5.3.4. Rules of pronominalization of the form shown in (5.148) are not upward bounded, as will be evident from the sentences of (5.174).

- (5.174) a. The boy who Mary_i loves hates her_i.
 b. The man who ordered a hotdog got one.
 c. Tom says that it's going to rain but I don't believe it.
 d. He said he would leave and now he's done it.
 e. I think that Mort's a swell guy, and Lenny thinks so too.
 f. Why can't the man who usually cuts the grass do so today?
 g. Mickey and Roger have signed, and Whitey will tomorrow.

The sentences in (5.175) show that the rule which introduces definite pronouns can go down into complex noun phrase, coordinate structures, left branches of larger noun phrases, and sentential subject clauses.

- (5.175)
- a. These shoes_i won't fit into the trunk they_i're next to.
 - b. Ronald_i scoffs at the belief that he_i would run if nominated.
 - c. Romeo_i conceded that he_i and Juliet were going steady.
 - d. Jocko_i carefully brushed off his_i tongue.
 - e. One dentist_i felt that for him_i to swim without a bathing suit would be too daring.

The major constraints proposed in Chapter 4 thus do not constrain the variable in this rule. That they also do not constrain the variables in the rules discussed in § 5.3.3 is indicated by the grammaticality of the examples in (5.176).

- (5.176)
- a. I lost a Japanese slide-rule, and the fact that Peter now has one I regard with suspicion.
 - b. The earth is flat, but will all those who don't believe it please raise their hands?
 - c. Pilots who can fly barrel rolls say that for me to try to do it in a glider would be hazardous.

- d. The passengers who had known that the train was not on fire said that those who had thought so had barricaded themselves in the bathrooms.
- e. Playing with matches is lots of fun, but doing so and emptying gasoline from one can to another at the same time is a sport best reserved for pyromaniacs.
- f. Swimming is fun, and I believe that people who can't should be taught to.

In these examples, I have not shown for each type of construction that it is not subject to each of the four constraints, but the examples given here should provide a sound enough basis for this generalization.

Although there are other constraints on particular rules of the form shown in (5.148), the condition stated in (5.152) seems to be the basic one governing all pronominalization rules which make crucial use of variables.³⁸ Condition (5.152) appears to be operative in French and German, as well as in English, but there are apparently languages in which only forward pronominalization is possible. In Finnish, and in Ijò and Gà, two languages of West Africa, this seems to be the case. I know of no language, however, in which backward pronominalization is as free as forward pronominalization, and it seems possible, at least at the present state of syntactic knowledge, to claim that if a language exhibits

backward pronominalization at all, then such pronominalization is subject to condition (5.152).

5.4. To summarize briefly, in this chapter I have argued that there are reordering transformations which make crucial use of variables, but which cannot be restricted correctly by either the principle of the transformational cycle or by the constraints developed in Chapter 4. I have provided additional evidence in support of Langacker's notion of command, showing that in addition to being necessary to restrict the operation of all feature-changing rules except pronominalizations, it can be extended in a natural way so that it correctly restricts the scope of the problematic reordering transformations. Finally, I have argued that Langacker's proposal to restrict with the notion of command the rule which introduces definite pronouns is inadequate, and that this rule, as well as all rules of pronominalization which make crucial use of variables, is subject to a different condition, which I stated in (5.152). Thus far, in my survey of restrictions on syntactic variables, for all constraints except those developed in Chapter 4, I have specified the formal properties of the rules which were subject to the constraints in question. Thus all pronominalizations which have the form of (5.148) are constrained by (5.152); all rules in which elements are permuted rightwards around, or adjoined to the right of, a variable term at the right end of a structural index, and all feature-changing rules, which have the form given in (5.78), are upward

bounded. In the next chapter, I will attempt such a formal specification of the class of all rules which are subject to the constraints of Chapter 4.

Chapter 5

FOOTNOTES

1. At present, there is no known principle of rule ordering, or combination of such principles, which can correctly account for all relevant facts of ordering. The difficulties which arise, by and large, have to do with various kinds of pronominalization. For an extended discussion of this area of study, cf. Lakoff and Ross (in preparation b).
2. Evidence that certain rules must be constrained not to apply until the last pass through the transformational cycle, where they may precede rules which apply on each pass through the cycle, is given in Lakoff (1966).
3. A detailed investigation of German intonation along these lines can be found in Bierwisch (1966).
4. For expository purposes, I have shown in (5.20) not an underlying structure, but an intermediate structure, to which the rules of Relative Clause Formation and Particle Movement, among others, have already applied.
5. Actually, it is not clear to me whether Chomsky's formulation of the principle, which I quoted in § 2.0, was meant to be strong

enough to have this effect, or whether a slightly stronger version would be necessary. For the present discussion, it is immaterial which is the case.

6. The fact that sentences (5.22a) and (5.22b) are of low acceptability, if not completely impossible, is accounted for by the Output Condition on Post-verbal Constituents (3.41) and is of no relevance to the present discussion. For the reasons I discussed in § 3.1.1.3.2, both of these sentences must be considered to be fully grammatical, though unacceptable.
7. The question of whether the extraposed S_3 should be dominated directly by S_2 or by the VP of S_2 need not concern us here.
8. In (5.27) and (5.28), I have assumed that the rule of Question has been reformulated along the lines of (4.135) Relative Clause Formation, so that the questioned constituent is Chomsky-adjoined to the sentence headed by Q. It is this operation of Chomsky-adjunction which is the source of the new node S_0 in (5.27) and (5.28).
9. For some discussion of the many exceedingly difficult problems concerning this rule, cf. Keyser (1967).

10. The fact that various sentences in (5.44) are rendered less than fully acceptable by the output condition stated in (3.27) need not concern us here - all should be considered to be grammatical.
11. This problem was brought to my attention by Michael L. Geis.
12. For the purpose of stating this rule, I will make the dubious assumption that there is a feature [+Adverb] which is assigned to all adverbs. Though trees (5.60) and (5.61) do not indicate the presence of this feature, it should be assumed to appear in them.
13. Klima analyzes ever in such sentences as (5.73c) as an obligatory morphophonemic variant of anytimes.
14. In Finnish, as in many other inflected languages, non-contrastively stressed subject pronouns are normally deleted.
15. David Perlmutter has called to my attention the fact that this rule is obligatory for accusatives in the same clause as the negative element (but cf. fn. 16), and optional for elements of what were^{lower}_e clauses in deep structure. He points out that this restriction is shared by the Russian rule for reflexivization, which must have the same restriction imposed on it. This is the only case I know of where a restriction which seems to have to be in a conditions box is not a restriction on a reordering transformation.

16. I have drastically oversimplified the facts in my presentation of this example. For example, while both (5.93a) and (5.93b) are possible, they have different meanings. If vodku (acc.) appears, the clause means 'who never drank vodka'; with vodki (gen.), it means 'who didn't drink any of the vodka.'
17. Since the reflexive pronoun sebja is used for all persons, the sentence on sostavil menja uvažat, sebja can also mean 'He forced me to respect myself.' For the present discussion, this reading can be disregarded.
18. The string in (5.106b) is a grammatical sentence, but it means 'That Mary was sick was obvious to me.' The fact that here zibun can only refer to the first person suggests that in the deep structure of (5.106b) must contain an earlier occurrence of the pronoun watakusi 'I'. Precisely this position is argued for in my forthcoming paper "On declarative sentences" (Ross (1967c)), where I present arguments that all declarative sentences must, in deep structure, be clauses embedded as the object of a verb of communication, like say or declare, with a first-person subject.
19. The reasons for not pruning S_1 in (5.112) will be gone into in Lakoff and Ross (in preparation b).
20. I am grateful to Paul Kiparsky for calling to my attention cases like (5.114), in which the tense-changing rule is obligatory.

21. Further research may reveal that it is normal for reflexivization rules to be both downward and upward bounded. In this case, the theory would have to mark the English rule as being normal, and the Japanese and Russian rules as being idiosyncratic in having an unusually wide range of application.
22. There are many other complex conditions which have to do with clitic placement, and these have extremely important consequences for the theory of grammar. This problem will receive intensive discussion in a forthcoming paper by E. Wayles Browne, III, and David M. Perlmutter.
23. For a formal definition of the notion tree, cf. Zwicky and Isard (1963).
24. The problem of why rules of reflexivization should behave not like rules of pronominalization, to which they are formally similar (cf. § 5.3 below), but like other feature-changing rules, with respect to the generalization in (5.122), will be taken up in § 6.5 below.
25. Note that even if it is argued that the analysis implicit in (5.131) is incorrect, and that the category S must be expanded by the rule $S \rightarrow NP \text{ Aux VP}$, and the category Aux by the rule $Aux \rightarrow Tns (M) (Perf) (Prog)$, the notion in construction with will

not allow the required change to take place if (5.127) is included in the grammar, under the assumption that the node on which the feature [Tense] is marked is the node Tns.

26. This definition is inadequate in that it does not come to grips with the problems brought up in footnote 19 of Chapter 3.
27. Anthony Naro has pointed out to me the extremely interesting fact that the sentence That the fuzz wanted to question John worried him, but it didn't worry Mary is ambiguous in the same way that (5.138a) is. This means that the definition of linguistic identity given in (5.135) must be revised in such a way that not only commanded pronouns can be disregarded, but also that noun phrases which have entered into an anaphoric relationship with some other noun phrase and pronominalized it can be disregarded under certain circumstances. I will not attempt such a revision here, for a full treatment of the many complex issues connected with the definition of identity is far beyond the scope of this work.
28. All the following remarks apply equally well to the as-clause of the comparison of equality.
29. At present, I know of no way of defining the term "the compared element." This thorny problem I will bequeath to future

researchers on the grammar of comparatives.

30. By the phrase "crucial use of variables", I mean all rules whose structural index contains a substring of the form $\dots A_1 X A_2 \dots$, or whose structural change specifies that some term is permuted around, or adjoined to, some term which contains a variable. Thus the rules of Indefinite Incorporation, (5.71), and Question, (4.1), make crucial use of variables, while the rule of It Deletion, (4.128), does not. This distinction between rule types has important consequences. For instance, it can be shown that no rules which make crucial use of variables are governed - that is, they can have no lexical exceptions.
31. For some discussion of this rule, cf. Ross (1967d).
32. In this rule, the letter A is a variable over node types, not strings.
33. In Postal (1966a), some concrete proposals of rules to effect these changes are made.
34. It is at present unknown as to whether a universal definition of the notion subordinate clause can be given, or whether it will be necessary to give a language-particular definition for each language in which this condition appears.

35. Indeed, the assumption that pronominalization should be effected by a syntactic rule, rather than by a semantic one, is also provisional. For arguments pro and con, see Lakoff (1967) and Jackendoff (1966a, b). There are so many mysteries connected with various kinds of pronominalization that almost nothing about it seems free of serious doubt.
36. For a discussion of some of the consequences of assuming that this is a syntactic rule, cf. Lakoff (1967).
37. For discussion of this construction, cf. Lakoff and Ross (1966), and Anderson (1967).
38. One interesting, if poorly understood, exception is the rule which produces anaphoric noun phrases like that idiot in such sentences as Wilfred_i raised his hand and then that idiot_i even tried to answer the question. This rule appears not to work backwards at all (witness the ungrammaticality of *After that idiot_i had shut up, everyone laughed at Wilfred_i.) and to work forward only under certain circumstances (cf. *Wilfred_i said that that idiot_i was going to get back at us.). The special nature of this rule was first pointed out to me by George Lakoff.

Chapter 6

ON THE NOTION "REORDERING TRANSFORMATION"

6.0. In Chapter 4, I presented evidence which showed that the rules of Relative Clause Formation and Question are subject to a variety of constraints. Since the facts cited in § 5.3.4 above show that these constraints do not affect rules of pronominalization, the question arises as to whether there are other rules than just the two studied in Chapter 4 which are subject to the constraints, and if so, whether it is possible to predict from the formal statement of a rule whether that rule will obey the constraints or not. This question has already been begged: the constraints in Chapter 4 were stated not in terms of the specific rules of Relative Clause Formation or Question, which were used to exemplify the effect of the constraints, but rather in terms of "reordering transformations". In this chapter, I will give a precise characterization of this presystematic term.

In § 6.1, I will describe briefly a large number of rules, some apparently related, some not, showing that each is subject to the constraints. In § 6.2, I will show that transformations which reorder a constituent, but leave behind a pro-form, to indicate the place the copied constituent occupied before the operation of the rule, are not affected by the constraints, and that it is rather transformations which "chop" a constituent and move it from its original position without leaving any trace, which are subject to the constraints. In § 6.3, I will show that even chopping transformations

are not subject to the constraints unless the chopped constituent it moved over a variable. In § 6.4, I will show that the feature-changing rules discussed in § 5.1.3 also obey the constraints. This fact leads to a theory of islands, the maximal domains of chopping and feature-changing rules. In § 6.5, a brief summary of the characterization arrived at is given.

6.1. Some Rules Obeying the Constraints

6.1.0. At the outset of my research on variables, I noticed that the German rule which preposes various types of constituents to the front of a sentence, thereby triggering a rule which inverts subject and verb (thus (6.1a) becomes (6.1b), (6.1c), or (6.1d)),

- (6.1) a. Ich sprach gestern mit Orje über Liebe.
 'I spoke yesterday with Orje about love.'
 b. Gestern sprach ich mit Orje über Liebe.
 c. Mit Orje sprach ich gestern über Liebe.
 d. Über Liebe sprach ich gestern mit Orje.

obeyed the same constraints as the rules of Relative Clause Formation and Question and the rules involved in cleft sentences, like (6.2), and pseudo-cleft sentences, like (6.3).

- (6.2) Es war gestern, dass ich mit Orje über Liebe sprach
 It was yesterday that I with Orje about love spoke
 'It was yesterday that I spoke with Orje about love.'

(6.3) Worüber ich gestern mit Orje sprach war Liebe.

Where about I yesterday with Orje spoke was love.

'What I spoke with Orje about yesterday was love.'

At that time, I concluded that the way to explain the similarity of the constraints on these rules was to assume that one rule was basic, and was a component of the operations of the other three rules. But Noam Chomsky pointed out to me an alternative possibility: this similarity of constraints might be derivable from some formal property shared by the four rules, rather than from some assumed common function or component. My further research proved Chomsky correct: there are a large number of transformations which obey the same constraints as the four rules that I had originally noticed, rules whose operations are far too dissimilar for it to be possible that there is one rule which is basic to each of these.

In my brief discussion of each of these rules, I will first give an example which is sufficiently complex to suggest that the scope of the rule is unboundedly large, and then give examples to show that the rule is subject to the Complex NP Constraint (CNPC), the Coordinate Structure Constraint (CSC), the Sentential Subject Constraint (SSC), and, where possible, the Left Branch Condition on pied piping (LBC). I have partitioned the rules into three arbitrary groups: the rules in § 6.1.1 produce clauses which resemble questions or relative clauses, some of which may derive

from rules which can be collapsed with the rules of Question and Relative Clause Formation¹. The rules in § 6.1.2 share only the property of producing structures which in no way resemble relative clauses. The rules in § 6.1.3 constitute the only counter-evidence I know of (but cf. § 6.4) to the claim that only "reordering transformations" are subject to the constraints of Chapter 4.

6.1.1.

6.1.1.1. One rule which results in question-like structures is the rule which produces exclamatory sentences, like those in (6.4).

- (6.4)
- a. How brave he is!
 - b. How surprisingly well he dances!
 - c. The bravery of our boys in Vietnam, Thailand, Cambodia, Korea, Malaya, Iceland, Nepal, Egypt, Turkey, Kazakhstan, Morocco, Haiti, Peru, Chile, Quebec, the Honduras, Baffinland, Monaco, and all the other places in the world where freedom needs protection!

I imagine that sentences like (6.4c), which consist of a single abstract NP, spoken reverentially, will derive from sentences like (6.4a), where he is replaced by our boys in Vietnam, etc., but I do not know how the rules that effect this conversion should be

formulated.

Although the sentences in (6.4) resemble questions, they are much more limited, for there are many question words that cannot head an exclamatory sentence, as (6.5) shows.

- (6.5) a. *Whether he left!
 b. *Why he knows the answer!²
 c. *Which boy is tall!

It seems likely to me that the restriction which is operative here is that it is only sentences with degree adverbs which can function in exclamatory sentences. This is indicated by the fact that if the word bravery, which is derived from a lexical item allowing degree modifiers (very brave), is replaced in (6.4c) by an abstract noun like arrival, whose underlying lexical item does not admit of degree modification (*very arrive, *arrive very), the sentence becomes ungrammatical. But there are several classes of counterexamples to this generalization (cf. e.g., the sentences in (6.6)), and although these seem intuitively to be different from the sentences in (6.4), I have no convincing arguments which show this to necessarily be the case.

- (6.6) ☆ a. When my daughter came home last night!³
 ☆ b. What my husband eats!
 ☆ c. Where my son and that girl he married are living!

But no matter what the source for such sentences as

those in (6.4) is, it is clear that the rule which forms them must be able to move the wh-ed constituents to the front of the sentence from indefinitely deeply embedded structures (cf. (6.7)).

(6.7) How brave everybody must think you expect me
to believe he is!

That this rule is subject to the CNPC, the CSC, and the SSC, can be seen from (6.8), (6.9), and (6.10), respectively.

(6.8) a. *How brave I know a boy who is!
b. How brave they must believe (*the claim) that
you are!⁴

(6.9) a. *How brave he is tall and!
b. *How brave Mike is cowardly and Sam is!

(6.10) a. *How brave that Tom is must be believed!
b. How brave it must be believed (?that) Tom is!⁵

That it is also subject to the LBC can be seen from the fact that it is (6.4a) that is grammatical, and not (6.11).

(6.11) *How he is brave!⁶

The reason that (6.11) is ungrammatical is the same as the one given for the ungrammaticality of (4.190), in § 4.3.2.1 above.

6.1.1.2. The first constructions which exhibit relative-clause-like structures are clauses introduced by where, when, after, before, since, until, and while. Michael L. Geis has proposed⁷ that all of these

clauses be treated as deriving from relative clauses on such head nouns as place or time. Thus at the time at which becomes at the time when, which may, by deletion of the NP at the time, result in a clause introduced by the single word when. That the source in the constituent sentence for the phrase at that time, from which this word derives, can be indefinitely far down the tree can be seen from (6.12),

- (6.12) Bill left when everyone will believe that the police have forced me to confess that I shot Sandra.

where the word when refers to the time of the shooting of Sandra. That the rule which forms such adverbial clauses, if it is different from the rule of Relative Clause Formation, which I doubt, is subject to the CNPC, the CSC and the SSC can be seen from (6.13), (6.14), and (6.15), respectively.

- (6.13) a. *Bill left when I am looking at a girl who vomited.
 b. Bill left when I believe (*the claim)(?that) the bomb had just exploded.
- (6.14) When I am awake (*at that time) and Susan is asleep, Bill will leave.
- (6.15) a. *Bill left when that noone else was awake is certain.⁸
 b. Bill left when it is certain that noone else was awake.

Sentences similar to these, which show the other adverbial clauses mentioned to be subject to the three major constraints, can also be constructed, but I will not undertake this here.

6.1.1.3. The second type of relative-clause-like construction is exemplified in (6.16):

(6.16) Here's a knife for you to cut up the onions with.

For to phrases can modify noun phrases in the same way as relative clauses. The subjects of these clauses can be deleted under interesting conditions (cf. (6.17)).

- (6.17) a. I brought a razor to shave $\left. \begin{array}{l} \text{myself} \\ * \text{himself} \end{array} \right\}$ with.
 b. I brought a razor with which to shave $\left. \begin{array}{l} \text{myself} \\ * \text{himself} \end{array} \right\}$.
 c. I brought John a razor to shave $\left. \begin{array}{l} * \text{myself} \\ \text{himself} \end{array} \right\}$ with.
 d. I brought John a razor with which to shave $\left. \begin{array}{l} * \text{myself} \\ \text{himself} \end{array} \right\}$.

The presence of the relative pronoun which in (6.17b) and (6.17d) suggests that whatever rule forms these clauses always preposes this pronoun to the front of the clause, deleting it obligatorily just in case the embedded subject has not been deleted. Thus (6.16) would be derived from the structure which underlies (6.18).

(6.18) *Here's a knife which for you to cut up the onions with.

Somehow the rule which forms these clauses must prevent a preposition

which precedes the NP to be relativized from pied piping, unless the subject of the clause has been (or will be?) deleted -- nothing can save a structure like (6.19), where the preposition with has pied piped, except possibly some ad hoc rule to reinsert the preposition where it came from, a rule unstateable under present conventions, in any account.

- (6.19) *Here's a knife with which for you to cut up
the onions.

Constituents can be moved by this rule from indefinitely far down the tree, as (6.20) shows.

- (6.20) Here's a plate for you to make Bob try to
begin to force his sister to leave the
cookies on.

I am not sure whether this rule can relativize elements from within that-clauses at all, but if so, it is only elements dominated by VP in such clauses, not subjects, that can be relativized. (6.21a) may be grammatical, but (6.22b) is almost certainly not.

- (6.21) a. ?Here's a knife for you to say that you cut
up the onions with.
b. *Here's a knife for you to say was on the table.

Thus we see that this rule, even if it should someday prove to be collapsible with the rule of Relative Clause Formation, will have to have a number of special restrictions imposed on it. And yet the

sentences in (6.22), (6.23), and (6.24) show it to be subject to the CNPC, the CSC, and the SSC, respectively.

- (6.22) a. *Here's a pole for you to kiss the girl who tied the string around.
- b. ?Here's a razor for you to announce (*the possibility) that you will shave with.
- (6.23) *Here's a razor for you to chop up these nuts with this cleaver and.
- (6.24) a. *Here's a razor for that you will be shaved with to be announced.
- b. ??Here's a razor for it to be announced that you will be shaved with.

Whether or not the LBC can be shown to be operative for this rule will depend upon it being possible to set up a contrast between such sentences as those in (6.25).

- (6.25) a. ?I loaned Maggie a Swiss Army knife with whose corkscrew to open the padlock.
- b. *I loaned Maggie a Swiss Army knife whose to open the padlock with corkscrew.

While it is clear that (6.25b) is word salad, I am not sure that (6.25a) is fully grammatical. If not, this rule cannot be shown to be subject to the LBC.

6.1.1.4. It is well-known that appositive clauses obey the same restrictions restrictive relative clauses do, but it may not have been observed before that sentential clauses, like those in (6.26), also do.

- (6.26) a. Fluffy is sick, which few people realize.
 b. Fluffy is sick, which I'm not sure you
 know Sarah expects me to believe Joan realizes.

Sentence (6.26b) suggests that this rule must be able to prepose the relative pronoun which, which stands for the sentence Fluffy is sick, from indefinitely deeply embedded positions, and sentences (6.27), (6.28), and (6.29) show that it too is subject to the CNPC, the CSC, and the SSC.

- (6.27) a. *Fluffy is sick, which I slapped a boy who
 wouldn't acknowledge.
 b. Fluffy is sick, which I believe (*the claim)
 that few people realize.
- (6.28) *Fluffy is sick, which I fell asleep and
 Tom suddenly realized.
- (6.29) a. *Fluffy is sick, which that noone here
 realizes is certain.
 b. Fluffy is sick, which it is certain that
 noone here realizes.

The same restrictions apply to sentential as-clauses: the word as can be substituted for which in sentences (6.26) - (6.29) with

no change in grammaticality, although this is not in general true. The sentences in (6.30) show that the rule which forms as-clauses must be sensitive both to the presence of certain types of negation and to the syntactic environment from which the constituent which as replaces comes.⁹

- (6.30) a. Fluffy is sick, $\left. \begin{array}{l} \text{which} \\ *as \end{array} \right\}$ nobody knows.
 b. Fluffy is sick, $\left. \begin{array}{l} \text{which} \\ as \end{array} \right\}$ not everybody knows.
 c. Fluffy is sick, $\left. \begin{array}{l} \text{which} \\ *as \end{array} \right\}$ surprises me.

These restrictions on as-clauses are unlike any known to obtain on relative clauses, restrictive or appositive, so I am highly doubtful that the rule which forms as-clauses can be collapsed with other rules which form relative clauses.

6.1.1.5. The rules that form cleft sentences, pseudo-cleft sentences, and topicalized sentences are also subject to the constraints. The sentences in (6.32) show them all to be subject to the CNPC, and those in (6.33), (6.34), and (6.35) show them to be subject to the CSC, the SSC, and the LBC, respectively, while the sentences in (6.31) show their scope to be unbounded.

- (6.31) a. It was this hat that Tom said Al thought you wanted me to make Jack put on.
 b. What Tom said Al thought you wanted me to make Jack put on was this hat.

- c. This hat Tom said Al thought you wanted me
to make Jack put on.
- (6.32) a. *It is this hat that I know the boy who is wearing.
b. It is this hat that I believe (*the claim)
that he was wearing.
c. *What I know the boy who was wearing is this hat.
d. What I believe (*the claim) that he was
wearing is this hat.
e. *This hat I know the boy who was wearing.
f. This hat I believe (*the claim) that he
was wearing.
- (6.33) a. *It is this hat that the gloves and were on
the table.
b. *What the gloves and were on the table was this hat.
c. *This hat the gloves and were on the table.
- (6.34) a. *It is this hat that that he was wearing is certain.
b. It is this hat that it is certain that he
was wearing.
c. *What that he was wearing is certain is this hat.
d. What it is certain that he was wearing is this hat.
e. *This hat that he was wearing is certain.
f. This hat it is certain that he was wearing.
- (6.35) a. *It was John's that I stole bike.
b. *The one whose I stole bike was John's.
c. *John's I stole bike.

Because of the many additional similarities shared by these constructions, I am inclined to think they all derive from the same deep structure source, although I can propose none that is convincing. But all that is at issue here is the fact that the set or sets of rules that produce these constructions are all subject to the constraints of Chapter 4.

6.1.1.6. The next relative-clause-like construction I will consider is that exemplified in (6.36).

(6.36) Maxwell isn't (half) the doctor that his
father was.

The fact that the element half can precede the modified NP in (6.36) shows that this sentence cannot be considered to be an instance of a predicate nominal modified by a relative clause, as in (6.37),

(6.37) Maxwell is the man who won the Nobel Prize
for horoscopy.

for if half is present in (6.36), the "relative clause" must be present, as the ungrammaticality of (6.38) indicates.¹⁰

(6.38) *Maxwell isn't half the doctor.

It seems probable that (6.36) can be related to such sentences as those in (6.39),

(6.39) a. Maxwell is quite $\left\{ \begin{array}{c} \text{a} \\ \text{the} \end{array} \right\}$ doctor.
b. Maxwell isn't much of a doctor.

c. Maxwell is more of a doctor than his son is. but no analysis of these constructions has been deep enough for this to be established positively. One final point of interest about these constructions is that the "relativized" element seems to have to follow the copula be in both the matrix and constituent sentences. When this strange constraint is violated, ungrammatical sentences such as those in (6.40) result.

- (6.40) a. *Maxwell isn't (half) the doctor that was here.
 b. *Maxwell isn't (half) the doctor that polished off the vodka.
 c. *(Half) the doctor that Maxwell's father was sat down.

As (6.41) suggests, the that-clause of (6.36) is not bounded in length:

- (6.31) Maxwell isn't (half) the doctor that I feared Marge would realize Tom had confessed that he knew Bill expected him to be.

Whatever rule it is that forms such clauses, it is subject to the CNPC, the CSC, and the SSC, as sentences (6.42), (6.34), and (6.44), respectively, show.

- (6.42) a. *Maxwell isn't half the doctor that I know an African chief who is.
 b. Maxwell isn't half the doctor that people around here believe (*the claim) that his father was.

- (6.43) *Maxwell isn't half the doctor that his sister is a psychologist and his father was.
- (6.44) a. *Maxwell isn't half the doctor that that he would be if he studied is certain.
- b. Maxwell isn't half the doctor that it is certain that he would be if he studied.

6.1.1.7. The last two cases of relative-clause-like constructions that I will discuss are those exemplified in (6.45).

- (6.45) a. He's the happiest that I've ever seen him.
- b. The hardest that it ever snowed was last January 12th.

I have grouped these two constructions together only on the basis of the fact that they both contain superlatives. What their deep structures are in fact, and whether the same rules are used in forming each, is anyone's guess. The grammar of superlatives, if it is not the most poorly understood of all problems yet investigated within the framework of generative grammar, is certainly not far off the pace.¹¹

That both of the that-clauses in (6.45) can be extended without bound is suggested by the random degree of complexity attained in (6.46).

- (6.46) a. He's the happiest that any of my friends could estimate anybody would expect you to believe that I've ever seen him.

- b. The hardest that I think I remember him ever telling me that he had heard of it snowing around here was last January 12th.

The rules that produce such constructions are subject to the three constraints of Chapter 4, as sentences (6.47)–(6.49) show.

- (6.47)
 - a. *He's the happiest that we ever talked to the boy who had seen him.
 - b. He's the happiest that I believe (*the claim) that he's ever been.
 - c. *The hardest that I ever knew a man who said that it had snowed was last January 12th.
 - d. The hardest that I believe (*the claim) that it ever snowed was last January 12th.
- (6.48)
 - a. *He's the happiest that I've ever seen him drunk and.
 - b. *The hardest that all the power lines were down and it snowed was last January 12th.
- (6.49)
 - a. *He is the happiest that that he has ever been is believed.
 - b. He is the happiest that it is believed that he has ever been.
 - c. *The hardest that that it has snowed here is believed was last January 12th.
 - d. The hardest that it is believed that it has snowed here was last January 12th.

6.1.2.

6.1.2.0. While no arguments are available (and I doubt that any are forthcoming) that all the above structures are offshoots of either the rule of Relative Clause Formation or the rule of Question, since all the constructions discussed exhibit some clause headed by a wh-word or the word that, it is at least logically possible that an analysis will someday be discovered which makes use of one of these two rules to derive all of the above constructions. But in the case of those constructions that I will discuss in this section, such an analysis would be inconceivable, for the structures produced contain relative-clause-like structures only incidentally, if at all.

6.1.2.1. The rule of Extrapolation from NP, (1.10), because of its formal structure, is upward bounded, so it is impossible to show with such sentences as (4.18) that it is subject to the CNPC; the same obtains for the SSC. It is, however, possible to show that it must be subject to the CSC. For consider structure (6.50):

(6.50)

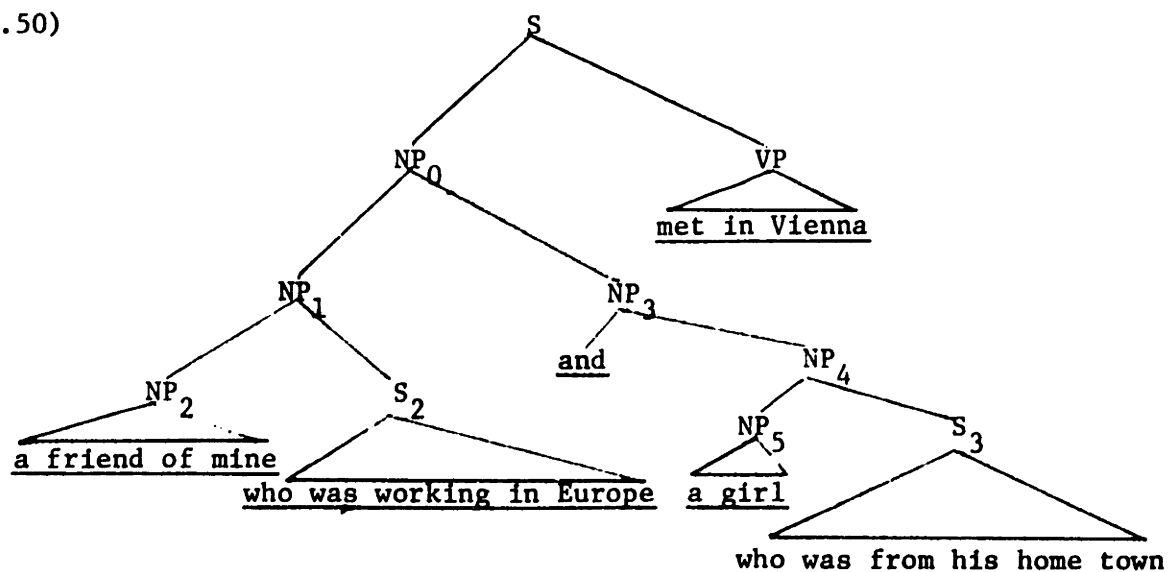

If the rule of Extrapolation from NP applied to this structure to move S_2 out of NP_1 , or S_3 out of NP_4 , one of the ungrammatical sentences in (6.51) would be generated.

- (6.51) a. *A friend of mine and a girl who was from his home town met in Vienna who was working in Europe.
- b. *A friend of mine who was working in Europe and a girl met in Vienna who was from his home town.

A similar example can be constructed to show that Extrapolation, (4.126), must also be subject to the CSC.

(6.52)

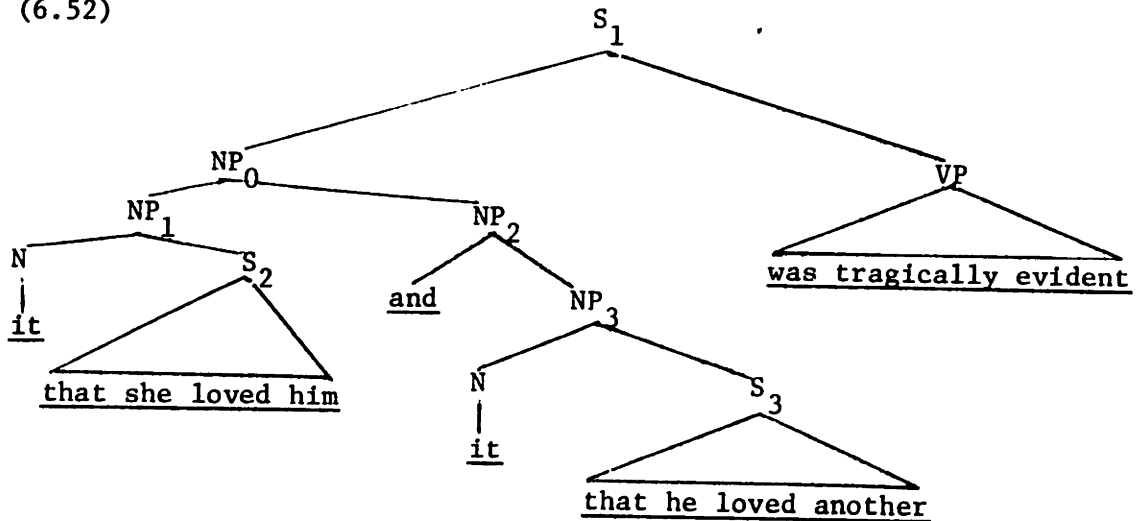

If Extrapolation does not apply to this structure, the rule of It Deletion, which was stated in (4.128), will delete both occurrences of it in (6.52), and the grammatical (6.53) will result.

(6.53) That she loved him and that he loved another
was painfully evident.

However, if Extrapolation were allowed to apply to either S_2 or S_3 in this structure, one of the ungrammatical structures in (6.54) would be produced.

- (6.54) a. *It and that he loved another was painfully
evident that she loved him.
b. *That she loved him and it was painfully
evident that he loved another.

The CSC must be invoked to block the generation of the sentences in (6.51), and it can also block the generation of those in (6.54). However, since it is not known what the relative ordering of the rules of Extrapolation and Conjunction Reduction is, it might be that the rules could be ordered in such a way as to prevent (6.54) without the CSC being necessary. But such a rule-ordering explanation is not available in the case of (6.51), for if the analysis presented in Lakoff and Peters (1966) is correct, the conjoined NP subject of such verbs as meet, similar, etc. is derived from a conjoined NP in deep structure. It therefore seems inescapable that the CSC must constrain the operation of at least one rule, Extrapolation from NP, which cannot be argued to be a subcase of the rules of Relative Clause Formation or Question.

6.1.2.2. Although the rule of NP Shift, (5.57), cannot be shown to be subject to the CNPC or the SSC, because it, like the two

extraposition rules, is subject to the stronger restriction of being upward bounded, it can be shown to obey the CSC, for the a-sentences below must not be converted into the b-sentences.

(6.55) a. Mary and [an old friend who comes from Miami]_{NP} kissed.

b. *Mary and kissed an old friend who comes from Miami.

(6.56) a. I gave a picture of a covered bridge and [a hundred hikers from Hoboken]_{NP} to my sister.

b. *I gave a picture of a covered bridge and to my sister a hundred hikers from Hoboken.

(6.57) a. Joan plays [a wonderful old guitar from Spain]_{NP} and sings folksongs.

b. *Joan plays and sings folksongs a wonderful old guitar from Spain.¹²

That the rule of NP Shift is also subject to the LBC was argued in § 4.3.2.1 above, in connection with the ungrammaticality of (4.188b) and (4.188c).

6.1.2.3. The rule of Conjunction Reduction, whose operation was described informally in § 4.2.4.1. above, is stated roughly as in (6.58).

(6.58) Conjunction Reduction

a. [and - [X - A]_Bⁿ]_B

1 2 3
[1 2 0]_B#3

OPT
⇒

$$b. \quad [\text{and} - [A - X]_B^n]_B$$

$$\begin{array}{ccc} 1 & 2 & 3 \\ 2\#[1 & 0 & 3]_B \end{array} \xrightarrow{\text{OPT}}$$

Condition: all occurrences of A are identical.

This notation should be interpreted to mean that in any coordinate node of the category B, which dominates any number of conjuncts which are also of the category B, and each of which either ends or begins with a constituent of category A, where all occurrences of A are identical, all of these occurrences of A are superimposed, and adjoined to the conjoined node B. Thus (4.118) could be converted into (4.119) by the operation of this rule.

This rule must be formulated in such a way as to reorder each instance of the category A, adjoining it to the coordinate node, for otherwise the following facts cannot be explained. If my intuitions are correct, (6.59a) cannot be converted into (6.59b), and (6.60a) can be converted into (6.60b) only if the parenthesized NP, the claim, is not present.

(6.59) a. Sally might be pregnant, and I know a girl who definitely is pregnant.

b.?* Sally might be, and I know a girl who definitely is, pregnant.

(6.60) a. Sally might be pregnant, and I believe (the claim) that Sheila definitely is pregnant.

- b. ?Sally might be, and I believe (?*the claim) that Sheila definitely is, pregnant.

Some speakers claim to find no difference between the version of (6.60b) in which the claim is present and the one in which it is not, or between (6.59b) and either of these. If all are held to be ungrammatical, then rule (6.58) must simply be restricted in such a way that the nodes A cannot be dominated by a that-clause. However, if all are held to be grammatical, then there is a serious inadequacy in my analysis, for I would hold that if a rule is subject to one of the constraints of Chapter 4, it must be subject to all. And it seems clear that at least the CSC must constrain the operation of rule (6.58), for I know of no one who finds the result of the conversion of (6.61a) into (6.61b) grammatical.

- (6.61) a. The younger woman might have been tall and blonde, and the older one definitely was blonde.

- b. **The younger woman might have been tall and, and the older one definitely was, blonde.

But the picture is complicated by the existence of such sentences as those in (6.62) and (6.63).

- (6.62) a. Sally is tall, and maybe blonde, and Sheila is short, and definitely is blonde.

- b. ?*Sally is tall, and maybe, and Sheila is short, and definitely is, blonde.

- (6.63) a. Hank plays the guitar and finds arrangements for all the old folksongs which are still sung in these hills, and Ernie writes down all the old folksongs which are still sung in these hills.
- b. ??Hank plays the guitar and finds arrangements for, and Ernie writes down, all the old folksongs which are still sung in these hills.

In my speech, (6.62b) and (6.63b) are clearly far better than (6.61b), but I am not confident enough of this judgment to assert that they should be considered fully grammatical. However, if all three are to be considered ungrammatical, as well as (6.59b) and the version of (6.60b) in which the NP the claim appears, at least the rule which converts (4.118) into (4.119) must be formulated as a reordering rule, and be subject to the CNPC and the CSC. That this rule must also be subject to the LBC was pointed out in § 4.3.2.4 above, in connection with the ungrammaticality of (4.239) (but cf. also the discussion of sentence (4.241)).

6.1.2.4. The next rule I will discuss in connection with the constraints of Chapter 4 is the rule which converts (6.64a) to (6.64b), by preposing a VP which immediately follows an emphatically stressed auxiliary verb, under various conditions which need not concern us here.

- (6.64) a. They said that Tom { would pay up, and he ^{did} pay up
 had gone home, and he ^{will} has gone home
 was working, and he ^{is} is working
- b. They said that Tom { would pay up, and pay up he ^{did}
 had gone home, and gone home he ^{will}
 was working, and working he ^{is}

The statement of this rule must make crucial use of a variable, as (6.65) suggests.

- (6.65) They said Tom would pay up, and pay up I'm
 sure everybody will tell you that his lawyers
 expect me to believe he ^{did}.

The rule is subject to the CNPC, the CSC, and the SSC, as can be seen from (6.66), (6.67), and (6.68), respectively.

- (6.66) a. They said nobody would pay up, but I know
 a boy who ^{did} pay up.
- b. *They said nobody would pay up, but pay up
 I know a boy who ^{did}.
- c. They said that Tom would pay up, and pay up
 I believe (*the claim) that he ^{did}.
- (6.67) a. They said that Tom wouldn't pay up, but he
^{did} go to the bank, and he ^{did} pay up.
- b. *They said that Tom wouldn't pay up, but pay
 up he ^{did} go to the bank and he ^{did}.
- (6.68) a. *They said that Tom would pay up, and pay up
 that he ^{did} is well-known.
- b. They said that Tom would pay up, and pay up
 it is well-known that he ^{did}.

6.1.2.5. The statement of the rule which converts (6.69a) into (6.69b) also must make crucial use of variables, as the complexity of (6.70) suggests.

- (6.69) a. Although Dick is handsome, I'm still going
marry Herman.
- b. Handsome though Dick is, I'm still going
to marry Herman.

(6.70) Handsome though everyone expects me to try
to force Bill to make Mom agree that Dick is,
I'm still going to marry Herman.

That this rule is subject to the CNPC, the CSC, and the SSC can be seen from sentences (6.71), (6.72), and (6.73), respectively.

- (6.71) a. *Handsome though I know several boys who are,
I'm still going to marry Herman.
- b. Handsome though I believe (*the claim) that
Dick is, I'm still going to marry Herman.

(6.72) *Handsome though Dick is fair, Nordic,
strong and, I'm still going to marry Herman.

- (6.73) a. *Handsome though that Dick will be is likely,
I'm still going to marry Herman.
- b. Handsome though it is likely that Dick will
be, I'm still going to marry Herman.

6.1.2.6. Whatever rule it is that derives sentences like (6.74) from some equally unknown deep structure, its statement must make

crucial use of a variable, as such sentences as (6.75), if they are grammatical, would suggest.

(6.74) The more contented we pretended to be, the more we grew angry at the doctors.

(6.75) ?The more contented the nurses began to try to persuade us to pretend to be, the more angry we grew at the doctors.

That this rule is subject to the CNPC, the CSC, and the SSC can be seen from sentences (6.76), (6.77), and (6.78), respectively.

(6.76) a. *The more contented I laughed at the nurse who thought that we were becoming, the more angry we grew at the doctors.

b. ??The more contented the nurses began to believe (*the claim) that we were going to pretend to be, the more angry we grew at the doctors.¹³

(6.77) *The more contented we pretended to be better fed and, the more angry we grew at the doctors.

(6.78) a. *The more contented for us to pretend to be became possible, the more angry we grew at the doctors.

b. ?The more contented it became possible for us to pretend to be, the more angry we grew at the doctors.

6.1.2.7. The next rule I will consider in this section is the rule which converts such sentences as (6.79a) into (6.79b), provided that the object of the preposition de has been pronominalized.

(6.79) a. J'ai une photo de cette maison.

I have a picture of this house.

b. J'en ai une photo.

I of it have a picture.

'I have a picture of it.'

This rule seems to be able to operate over a potentially indefinitely large portion of a tree, as (6.80b), which results from (6.80a) if the NP la table 'the table' has been pronominalized, shows.¹⁴

(6.80) a. Je vois le bout du toit de l'aile

I see the end of the roof of the wing
gauche de la maison.

left of the house.

'I see the end of the roof of the left wing of the house.'

b. J'en vois le bout du toit de l'aile gauche.

I of it see the end of the roof of the wing left.

'I see the end of the roof of its left wing.'

This rule is subject to a stronger constraint than the combination of the CNPC and the SSC -- it is upward bounded.¹⁵ It can be shown to be subject to the CSC by the fact that (6.81a) cannot become (6.81b) if the NP la maison 'the house' has been pronominalized.¹⁶

- (6.81) a. Je vois la porte du garage et le toit
I see the door of the garage and the roof
de la maison.
of the house.
- b. *J'en vois la porte du garage et le toit.¹⁷

6.1.2.8. The last rule I will deal with in this subsection, the rule which produces structures like (6.82),

(6.82) I have some papers to grade.

also seems not to be able to move NP's out of tensed clauses (cf. (6.83)),

(6.83) ?*I have some papers to announce that I've
got to grade.

although this rule appears to be able to range indefinitely far down into a tree, as (6.84) suggests.

(6.84) I have some papers to try to finish grading.

It is not clear to me whether sentences (6.82) and (6.84) can be argued to be synonymous with any reading of (6.85a) and (6.85b), respectively.

(6.85) a. I have to grade some papers.

b. I have to try to finish grading some papers.

If their meaning is correct, they are the most obvious source for (6.82) and (6.84). But if they cannot be the source for these sentences, I am at a loss to suggest what might be. It seems unlikely that a structure like that shown in (6.86) can serve as a source;

(6.86)

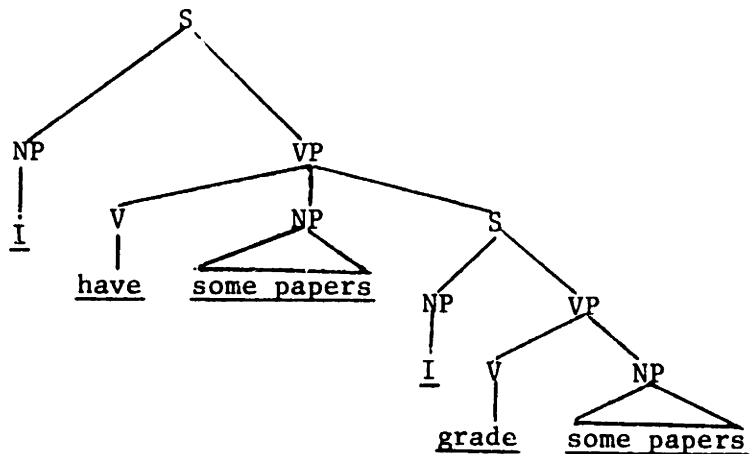

for there are sentences like (6.87),

(6.87) I have getting into college to consider.

where the NP that directly follows have in surface structure is abstract, and I know of no other verb which takes an NP S object (e.g., verbs like compel, motivate, challenge, etc.), where the NP can be inanimate.

However, no matter what the source of such sentences is, the fact that the rule that produces them obeys the CSC and the LBC can be seen from the ungrammaticality of the sentences in (6.88) and (6.89).

(6.88) a. *I have some papers to grade these exams and.

b. *I have some voice exercises to play the guitar and sing.

(6.89) *I have John's to grade paper.

6.1.3.

6.1.3.0. In § 4.1.4 above, I argued from the fact that the rule which forms relative clauses in Japanese is subject to the crossover

condition, (4.30), and to the CNPC (it is also subject to the CSC, but not to the SSC, as I showed in § 4.4.1) to the conclusion that the rule must be formulated as a "reordering transformation" (in a sense which will be made more precise in § 6.2 and §6.3 below). This is only one of the possible conclusions: the other is that it is not the case that the crossover condition and the constraints of Chapter 4 only affect "reordering transformations"; rather, there are some transformations whose only effect is to delete constituents under identity, but which are nonetheless still subject to the constraints. The question then arises as to how such deletions are to be distinguished from other rules of pronominalization, which I showed, in § 5.3.4, not to be subject to the constraints of Chapter 4. This question will be taken up in § 6.4 below.

6.1.3.1. The first two pronominalization-like rules I will consider are those which produce those comparative constructions which exhibit the morphemes -er...than and as...as. Since these two constructions behave alike in all respects of interest here, I will give examples of only the former construction.

As (6.90) suggests, than-clauses of any desired length can be constructed.

(6.90) Wilt is taller than I imagine anybody would
 ever guess that people had begun expecting
 Red to announce that he was.

One of the operations that takes place in the formation of than-clauses is that the compared element in the than-clause is obligatorily deleted if it is identical to the element of the main clause with which it is compared. Thus in (6.91a), because the two compared adjectives are dissimilar, the one in the than-clause is retained. In (6.91b), however, since the compared adjectives are identical, the parenthesized occurrence in the than-clause is obligatorily deleted.

- (6.91) a. The sofa was longer than the room was wide.
 b. The sofa was longer than the desk was (long).

This deletion operation is subject to the CNPC, the CSC, and the SSC, as the sentences in (6.92), (6.93), and (6.94) show.

- (6.92) a. *Wilt is taller than I know a boy who is.
 b. Wilt is taller than I believe (*the claim) that Bill is.

- (6.93) a. *Wilt is taller than Bill is strong and.
 b. *Dean drank more booze than Frank ate Wheaties and Sammy drank.

- (6.94) a. *Wilt is taller than that Bill is is generally believed.
 b. Wilt is taller than it is generally believed that Bill is.

There is another deletion rule which is subject to the constraints and which is probably best treated as being a special case of the rule which forms comparatives. In sentences containing

-er...than or inherently comparative verbs like increase, diminish, outrun, overthrow, etc., it is possible to have by-phrases, like those in (6.95), which make precise the amount by which the compared elements differ.¹⁸

- (6.95) a. Wilt is taller than Bill by 7 millimeters.
 b. The raise which Scrooge generously gave Tom's father increased his yearly salary by five cents.
 c. The hare outran the tortoise by so much that he forgot the latter was even in the race any more.
 d. Who knew Mickey would overthrow home plate by that much?

If two sentences contain such by-phrases, as is the case with the sentences of (6.96),

- (6.96) a. Wilt is taller than Bill by that much.
 b. Big O is taller than the Cooz by that much.

then it is possible for one sentence to appear as a subconstituent of the other, superficially, at least, as a degree modifier of much. Thus (6.96b) can become a modifier of the occurrence of much in (6.96a), as in (6.97).

- (6.97) Wilt is taller than Bill by as much as Big O is taller than the Cooz.

The objects of the preposition by can also be compared, as is the case in (6.98).

(6.98) Wilt is taller than Bill by more than Big O
is taller than the Cooz.

Exactly what the rule is which is at work here is not my concern: for my present purposes it is sufficient to point out that this apparent rule of deletion has an unbounded scope (this is suggested by (6.99)),

(6.99) Wilt is taller than Bill by as much as
everybody seems to expect me to admit to
having publicly proclaimed that I believed
Big O to be taller than the Cooz.

and that it is subject to the CNPC, the CSC, and the SSC (cf. (6.100), (6.101), and (6.102), respectively).

(6.100) a. *Wilt is taller than Bill by as much as I
know a boy who thinks that Big O is taller
than the Cooz.

b. Wilt is taller than Bill by as much as
Peter believes (*the claim) that Big O is
taller than the Cooz.

(6.101) *Wilt is taller than Bill by as much as I
watch all the games and I know Big O is
taller than the Cooz.

(6.102) a. *Wilt is taller than Bill by as much as that
Big O is taller than the Cooz is believed.

b. Wilt is taller than Bill by as much as it
is believed that Big O is taller than the
Cooz.

6.1.3.2. The second deletion rule which obeys the constraints is the rule which converts (6.103a) into (6.103b), sometimes optionally, sometimes obligatorily.

(6.103) a. ?The rock was too heavy for me to pick it up.

b. The rock was too heavy for me to pick up.

I am not entirely sure of this, but I believe that this rule must be allowed to delete elements which are indefinitely far down in a tree (cf. (6.104)).

(6.104) a. This rock is too heavy for me to begin to decide about helping Bob to try to pick it up.

b. ??This rock is too heavy for me to begin to decide about helping Bob to try to pick up.

Even if it is possible to find indefinitely long examples of this construction, a restriction must apparently be stated so that elements of clauses containing finite verbs will not be deleted: no grammatical sentences like (6.105) appear to exist.

(6.105) *This rock is too heavy for us to try to claim that we picked up.

If this rule is formulated with variables, it must be made subject to the CSC, the SSC, and the LBC, as (6.106), (6.107) (if grammatical sentences like (6.107b) exist), and (6.108) show.

(6.106) a. Sodium is a little too peppy for me to want to try mixing it and water in a teacup.

b. * Sodium is a little too peppy for me to want to try mixing and water in a teacup.

- (6.107) a. *That piece of ice is too big for for him to be able to pick up with a teaspoon to be likely.
- b. ??That piece of ice is too big for it to be likely for him to be able to pick up with a teaspoon.
- (6.108) a. Bob is too thin for me to be able to squeeze into his jacket.
- b. *Bob is too thin for me to be able to squeeze into jacket.

The rule which is at work here can probably be collapsed with the rule which converts (6.109a) into (6.109b),

- (6.109) a. This rock is light enough for Marcia to pick it up.
- b. This rock is light enough for Marcia to pick up.

for the grammaticality of sentences (6.103)-(6.108) is not affected by the substitution of Adj+enough for too+Adj.

6.1.3.3. A rule possibly related to this last rule is the one which converts (6.110a) into (6.110b):

- (6.110) a. The socks are ready for you to put them on.
- b. The socks are ready for you to put on.

Once again, although it is difficult to construct long examples, it may be the case that this deletion rule can operate over indefinitely long stretches of phrase markers (Cf. (6.111)).

- (6.111) a. The socks are ready for you to go about beginning to put them on.
- b. ?The socks are ready for you to go about beginning to put on.

As was the case with the previous rule, this rule seems not to be able to delete elements of clauses containing finite verbs (cf. (6.112)).

- (6.112) a. The socks are ready for you to announce that you will put them on.
- b. *The socks are ready for you to announce that you will put on.

If this rule must be stated with variables, then it must also be subject to the CSC and the LBC, as (6.113) and (6.114) show. Sentence (6.115a) shows that it is not possible to delete elements of sentential subject clauses, but I have not been able to find sentences like (6.115b), where the deletion has become possible after the extraposition of the clause, so it may be that this rule is subject to a stronger constraint than the previously discussed rules in this section.

- (6.113) a. The socks are ready for you to try them and the garters on.
- b. *The socks are ready for you to try and the garters on.
- (6.114) a. Pfc. Golliwog is ready for you to inspect his bunk.
- b. *Pfc. Golliwog is ready for you to inspect bunk.

(6.115) a. * The socks are ready for for you to put
on to be planned.

b. * The socks are ready for it to be planned
for you to put on.

The facts that I have brought out here in connection with ready hold true for a small class of similar adjectives, such as suitable, fit, convenient, etc., none of which can be provided with a plausible deep structure source at present.

They also hold true for adjectives like easy, difficult, hard, etc., which occur in constructions like (6.116).

(6.116) It is $\left. \begin{array}{l} \text{easy} \\ \text{difficult} \\ \text{hard} \end{array} \right\}$ to play sonatas on this
violin.

It has been assumed in previous transformational studies (cf., e.g., Rosenbaum (1965)) that sentences like those in (6.117) are to be derived from the structure underlying (6.116) by a reordering transformation which substitutes some NP in the extraposed clause of (6.116) for the subject of (6.116), the pronoun it.

(6.117) Sonatas are $\left. \begin{array}{l} \text{easy} \\ \text{difficult} \\ \text{hard} \end{array} \right\}$ to play on this
violin.

Recently, however, several new facts have come to light which cast doubt on the correctness of this analysis. Klima has pointed out to me that both (6.117) and (6.118), which are not synonymous, would be derivable from the structure underlying (6.116).

(6.118) This violin is $\left\{ \begin{array}{l} \text{easy} \\ \text{difficult} \\ \text{hard} \end{array} \right\}$ to play sonatas
on.

Similarly, Perlmutter has observed (cf. Perlmutter (op. cit.)) that the sentences of (6.119), which would have the same deep structure, are also not synonymous.

- (6.119) a. I made John easy to get along with.
b. I made it easy to get along with John.

A more serious problem is posed by such sentences as (6.120).

(6.120) John tries to be easy to get along with.

Perlmutter (op. cit.) argues that it is incorrect to analyze try as being lexically marked in such a way that the rule of Equi NP Deletion must apply to delete the superficial subject of the next sentence down, as was proposed in Lakoff (1965). He presents a number of convincing arguments, all of which suggest that in the correct analysis of try, the fact that such sentences as (6.121) are ungrammatical

(6.121) * John tried (for) Bill to play whist.

will be attributed to a deep structure restriction that the verb try requires its deep subject to be the same as the deep subject of the complement sentence.

If Perlmutter's hypothesis that the constraints on try are to be stated in terms of deep structure, rather than in terms of derivations, ^{is correct} then the fact that (6.120) is grammatical forces the conclusion that the deep subjects of easy in (6.117) and (6.118) are

sonatas and violin, respectively. And the underlying structure of the constituent sentence in (6.120) would be roughly that shown in (6.122):

(6.122)

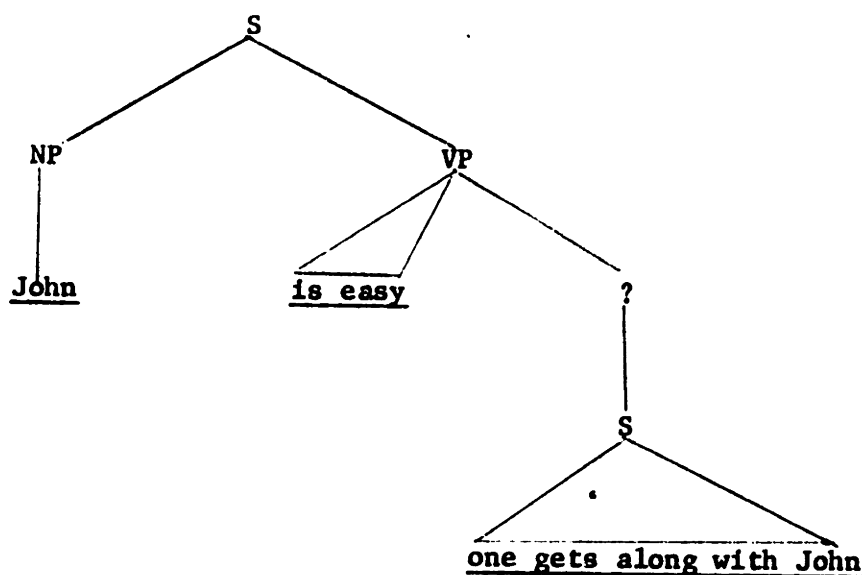

Thus the rule that forms such sentences as (6.117) and (6.118) is a deletion rule, like the other rules discussed in § 6.1.3, and not a reordering rule, like those discussed in §§ 6.1.1 - 6.1.2, unless the above arguments can be gotten around. This rule appears not to be able to delete elements of clauses containing finite verbs (cf. (6.123)),

(6.123) ?* These flowers would be easy for you to
say that you had found.

and to be subject to the CSC (cf. (6.124)).

(6.124) * My mother is easy to please my father and.

As is the case with adjectives like ready, a stronger constraint than the SSC seems to be operative here, for neither (6.125a) nor (6.125b) is grammatical.

(6.125) a. * Bill would be easy for for you to chat
with in Moscow to become expensive.

b. * Bill would be easy for it to become
expensive for you to chat with in Moscow.

6.2. Chopping Rules

6.2.0. In §§ 6.1.1 - 6.1.2, I gave a large list of "reordering transformations" -- rules whose structural change specifies that some term of the structural index is to be moved around some other term of it -- and showed that each was subject to the constraints of Chapter 4. In this section, I will demonstrate that there are rules which perform such an operation, but yet are not subject to the constraints. It is possible, however, to find an important formal difference between reordering rules which are subject to the constraints, and reordering rules which are not: in rules of the first type, if a term of the structural index is adjoined to, or permuted around another term, the original term is deleted or substituted for. But in rules of the second type, the original term is not deleted, but remains behind in pronominal form, as a kind of place-marker.

- b. My father, the man he works with in
Boston is going to tell the police that ...
- c. (In) Boston, the man my father works with } there
is going to tell the police that ... } *in it
- d. The police, the man my father works with
in Boston is going to tell them that ...
- e. That traffic expert, the man my father
works with in Boston is going to tell the
police that he has set that traffic light
on the corner of Murk Street far too slow.
- f. That traffic light on the corner of Murk Street,
the man my father works with in Boston is
going to tell the police that that traffic
expert has set it far too slow.
- g. (?On) the corner of Murk Street, the man my
father works with in Boston is going to tell
the police that that traffic expert has set
that traffic light there far too slow.
- h. Murk Street, the man my father works with in
Boston is going to tell the police that that
traffic expert has set the traffic light
- { on the corner there }
{ on that corner } far too slow.
{ * on it }

The fact that the versions of (6.128c) and (6.128h) which contain the definite pronoun it is obviously the same as the fact that the sentences in (4.204) are ungrammatical, and both would be excluded by some restriction along the lines of that proposed in Kuroda (1964). Another restriction on this rule is that it only places constituents at the head of main clauses: while (6.129) is grammatical,

(6.129) My father, he's Armenian, and my mother, she's Greek.

to my ear, the sentences in (6.130) sound unacceptable.

- (6.130) a. * That my father, he's lived here all his life is well known to those cops.
 b. * If my father, he comes home late, my mother always grills him.
 c. * It started to rain after Jackie and me, we had finally gotten to our seats.

This restriction is somewhat too strong, for sentences in which this rule has applied in certain object clauses seem to be acceptable (compare (6.131a) with (6.131b)), and, mysteriously, sentences like (6.130b) seem to be improved if the rule has applied in both clauses (cf. (6.132)).

- (6.131) a. ?* I acknowledged that my father, he was tight as a hoot-owl.
 b. I said that my father, he was tight as a hoot-owl.

- (6.132) ? If my father, he comes home late, my
mother, she always grills him.

Note in passing that the same restriction about subordinate clauses also obtains for Topicalization. Thus such sentences as those in (6.133) are ungrammatical.

- (6.133) a. * That beans he likes is now obvious.
b. * I'm going to write to the Game Warden
if more than one deer my neighbor brings
back.
c. * I don't know the boy { who the flowers Mary gave to
the flowers who Mary gave to }.

Again, topicalization is sometimes possible in clauses and object position, though not in clauses and subject position.

- (6.134) a. ? The Revenooers claim that informers they
never use.
b. * That informers they never use is claimed
by the Revenooers.

As my purpose is not to present a maximally correct formulation of each of these rules, I shall disregard these improvements and pass on to the main business at hand: a comparison of the constraints to which (4.185) and (6.126) are subject.

Notice that noun phrases can be dislocated out of complex NP (cf. the b, c, g, and h-versions of (6.128)), out of coordinate structures (cf. (6.135)), out of sentential subject clauses

(cf. (6.136)), and out of left branches of larger NP (cf. (6.137)). And the distance that the dislocated NP has traveled in (6.128h) suggests that the statement of the rule must make crucial use of a variable.

- (6.135) a. My father, I hardly ever see him and
my mother when they're not glaring at
each other.
- b. This guitar, I've sung folksongs and
accompanied myself on it all my life.
- c. Poor Jonesy, it had started to rain and
he had no umbrella.
- (6.136) My father, that he's lived here all
his life is well-known to the cops.
- (6.137) My wife, somebody stole her handbag
last night.

Thus Left Dislocation is not subject to the CNPC, the CSC, the SSC, or the LBC. But I showed in § 6.1.1.5 and in § 4.3.2.1 that Topicalization is subject to all these constraints. Since both rules reorder term 2 of their structural index, some formal distinction between them must be found, if the generalization that all reordering transformations obey the constraints is to be retained.

A distinction which appears to be adequate is that between copying transformations and chopping transformations (cf. (6.138)).

(6.138) If the structural index of a transformation has n terms, a_1, a_2, \dots, a_n , it is a reordering transformation if its structural change has any a_i as its k^{th} term, or if a_i is adjoined to its k^{th} term, where $i \neq k$.

If a transformation reorders a_i , and its structural change substitutes the identity element or some a_k , $i \neq k$, for the i^{th} term of the structural index, the transformation is a chopping transformation. Other reordering transformations are called copying transformations.

For example, if the structural index of a transformation were that shown in (6.139), it would be a chopping transformation (or rule) if any of the lines in (6.140) were its structural change, but it would be a copying rule if any of the lines in (6.141) were.

$$(6.139) \quad \begin{array}{cccc} a_1 & - & a_2 & - & a_3 & - & a_4 \\ 1 & & 2 & & 3 & & 4 \end{array}$$

$$(6.140) \quad \begin{array}{l} \text{a.} \quad 1 \quad 3 \quad 2 \quad 4 \\ \text{b.} \quad 1 \quad 2+3 \quad 0 \quad 4 \\ \text{c.} \quad 1 \quad 0 \quad 3 \quad 4+2 \\ \text{d.} \quad 4 \# \left[\begin{array}{cccc} 1 & 0 & 3 \# 2 & 0 \end{array} \right] \\ \text{etc.} \end{array}$$

- (6.141) a. 2+1 2 3 4
 b. 1+2 2 3 4
 c. 1 2 3 4+2

etc.

The generalization for which this distinction is crucial is that stated in (6.142).

- (6.142) Chopping rules are subject to the constraints of Chapter 4; copying rules are not.

Since Topicalization is a chopping rule, it is subject to the constraints. Since Left Dislocation is not, it is not subject to them.

The generalization in (6.142) is really a shorthand way of rewording all the constraints of Chapter 4. Thus the CSC, (4.84), instead of stating "... no conjunct may be moved....", should state "... no conjunct may be chopped ...", and similarly for the other constraints of Chapter 4. Such a restatement will be postponed until § 6.5 below.

6.2.2. For another clear contrast between copying and chopping rules, consider the rule of Right Dislocation:

- (6.143) Right Dislocation

$$\begin{array}{rcccl}
 X & - & \left[\begin{array}{c} \text{NP} \\ -\text{Pro} \end{array} \right] & - & Y \\
 1 & & 2 & & 3 \\
 \left[1 & & \left[\begin{array}{c} 2 \\ +\text{Pro} \end{array} \right] & & 3 \right] \# 2
 \end{array}
 \quad \Longrightarrow$$

This rule converts the structure underlying (6.144) into

any one of the structures underlying (6.145).

- (6.144) The cops spoke to the janitor about that robbery yesterday.
- (6.145) a. They spoke to the janitor about that robbery yesterday, the cops.
- b. The cops spoke to him about that robbery yesterday, the janitor.
- c. The cops spoke to the janitor about it yesterday, that robbery.

This rule is, as (5.123) would predict, upward bounded. This can be seen from the contrast in grammaticality between (6.146) and (6.147):

- (6.146) a. That they spoke to the janitor about that robbery yesterday, the cops, is terrible.
- b. That the cops spoke to the janitor about it yesterday, that robbery, is terrible.
- (6.147) a.?* That they spoke to the janitor about that robbery yesterday is terrible, the cops.
- b.?* That the cops spoke to the janitor about it yesterday is terrible, that robbery.

Sentences like those in (6.146) show that this rule is unlike the rule of Left Dislocation in that it can copy a constituent at the end of a subordinate clause, while Left Dislocation must be restricted to main clauses.

The specification in term 2 of (6.143) that the NP to be right-dislocated not be a pronoun is necessary to exclude such sentences as those in (6.148).

- (6.148) a. * They let him go yesterday, $\left\{ \begin{array}{l} \text{he} \\ \text{him} \end{array} \right\}$.
- b. I like beer, $\left\{ \begin{array}{l} *I \\ ?*me \end{array} \right\}$.
- c. * We'll go together, $\left\{ \begin{array}{l} \text{we} \\ \text{us} \end{array} \right\}$.
- d. * They can't stand each other, $\left\{ \begin{array}{l} \text{they} \\ \text{them} \end{array} \right\}$.

The restriction is stated somewhat too strongly, at present, for it would not allow the generation of such sentences as those in (6.149), unless a coordinate NP, all of whose conjuncts have the feature [+ Pro] can still be argued to have the feature [- Pro], which seems unlikely to me.

- (6.149) a. We'll do it together, you and $\left\{ \begin{array}{l} I \\ me \end{array} \right\}$.
- b. They can't stand each other, $\left\{ \begin{array}{l} \text{he and she} \\ \text{him and her} \end{array} \right\}$.

Note that the rule of Left Dislocation does not require the NP to be dislocated not to be a pronoun -- the sentences in (6.150), which correspond to those in (6.148), are grammatical.²⁰

- (6.150) a. $\left\{ \begin{array}{l} *He \\ Him \end{array} \right\}$, they let him go yesterday.
- b. $\left\{ \begin{array}{l} *I \\ Me \end{array} \right\}$, I like beer.

- c. $\left. \begin{array}{l} *We \\ Us \end{array} \right\}$, we'll go together.
- d. $\left. \begin{array}{l} *They \\ Them \end{array} \right\}$, they can't stand each other.

Once again, however, I am not concerned with fine points in the formulation of Right Dislocation -- my main purpose here is to show how the constraints on this copying rule differ from those on the rule of NP Shift, (5.57); for except for the various minor conditions stated on each rule, their only difference is that the former is a copying rule, while the latter is a chopping rule.

Since both rules are upward bounded, they will of course both be subject to the CNPC and the SSC. The sentences in (6.151) are a syntactic minimal pair: the ungrammaticality of (6.151a) and grammaticality of (6.151b) shows that the CSC restricts the operation of only the rule of NP Shift. And the sentences in (6.152) show the same to be true of the LBC.

(6.151) a. * I saw Mary and downtown yesterday your
friend from Keokuk.

b. I saw Mary and him downtown yesterday,
your friend from Keokuk.

(6.152) a. * I noticed car in the driveway last night
your friend from Keokuk.

b. I noticed his car in the driveway last
night, your friend from Keokuk.

In § 4.3.2.3. above, I presented evidence showing that a constraint is necessary, to the effect that no NP can move rightwards out of a prepositional phrase, thereby stranding the preposition (cf. (4.231)). In connection with my remark that the generalization in (6.142) is a shorthand way of rewording the constraints of Chapter 4, condition (4.231) should be reinterpreted as a constraint not on all reordering transformations, but only on chopping transformations. The sentences in (6.153) constitute another minimal pair which shows the need for this distinction: that (6.153a) is ungrammatical, but not (6.153b), shows that only NP Shift, and not Right Dislocation, is subject to (4.231).

- (6.153) a. * I spoke to about the war yesterday
 that guy who's always following us.
- b. I spoke to him about the war yesterday,
 that guy who's always following us.

6.2.3. Distinguishing between copying and chopping rules will also provide an explanation of the following fact, which is otherwise puzzling. There is a dialect of English in which all the sentences in (6.154) are perfectly grammatical.

- (6.154) a. I just saw that girl who Long John's claim
 that she was a Venusian made all the
 headlines.

- b. All the students who the papers which they submitted were lousy I'm not going to allow to register next term.
- c. Didn't that guy who the Game Warden and him had seen a flying saucer crack up?
- d. Palmer is a guy who for him to stay in school would be stupid.
- e. The only kind of car which I can never seem to get its carburetor adjusted right is them Stanley Steamers.
- f. King Kong is a movie which you'll laugh yourself sick if you see it.

The rule that forms this type of relative clauses would appear to differ from (4.135), the more usual rule, only in that the structural change of (4.135) specifies that term 4, the relativized element, is to be deleted, whereas this rule would only pronominalize term 4. Thus this rule is a copying rule, while (4.135) is a chopping rule. And, as (6.142) predicts, this rule is subject to none of the constraints: in (6.154a) and (6.154b), elements of complex NP's have been relativized; in (6.154c), a conjunct has been, and in (6.154d), a constituent of a sentential subject clause. In (6.154e), an NP on the left branch of a larger NP has been relativized, and in (6.154f), an element of a subordinate clause has been. If any of the boxed pronouns

in (6.154), which this rule leaves behind, are deleted, as would be the case if (4.135) had applied, none of the resulting sentences is grammatical.

Such sentences as those in (6.154), while common in almost everyone's speech, are regarded as substandard by normative grammarians. But there are languages whose relative clauses are normally formed by a copying rule like the one responsible for the sentences of (6.154), and in these languages, such sentences are regarded as fully grammatical. Michael Brame has informed me²¹ that this is the case in several dialects of Arabic.

6.2.4.

6.2.4.1. If the correct analysis of appositive clauses is that implied in § 4.2.3. above, where I stated that the second conjoined S of (4.115) could be inserted into the first, in apposition to the NP Pietro, then the rule which forms these clauses is a chopping rule, and it violates the CSC. This rule would be one of the two chopping rules I know of which seem not subject to all the constraints of Chapter 4. It therefore merits very careful scrutiny.

There are two arguments for deriving appositive clauses from coordinate structures. The first is that there are cases where such clauses can begin with and, as in (6.155).

(6.155) Enrico, $\left\{ \begin{array}{l} \text{who} \\ \text{and he} \end{array} \right\}$ is the smartest of us all,
got the answer in seven seconds.

The second argument is that after NP's whose determiners are any, no, every, etc., appositive clauses cannot appear (cf. (6.156)),

(6.156) * $\left\{ \begin{array}{l} \text{Any} \\ \text{No} \\ \text{Every} \end{array} \right\}$ student, $\left\{ \begin{array}{l} \text{who} \\ \text{and he} \end{array} \right\}$ wears socks, is
a swinger.

and that in these cases are the corresponding conjoined sentences also impossible:

(6.157) * $\left\{ \begin{array}{l} \text{Any} \\ \text{No} \\ \text{Every} \end{array} \right\}$ student is a swinger and he wears
socks.

These arguments are valid, and the facts they are based on must be explained somehow.

But there is a problem here: how are sentences like (6.158) to be generated?

(6.158) Is even Clarence, who is wearing mauve
socks, a swinger?

This sentence cannot be derived from the structure shown in (6.159),

(6.159)

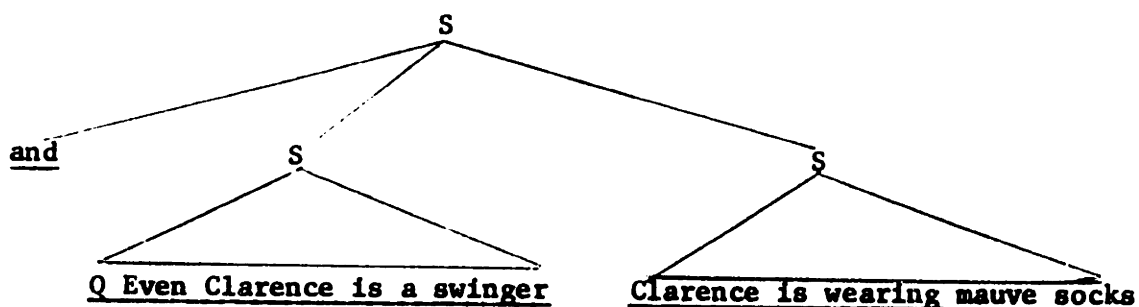

for the arguments in § 4.2.4.3 showed that such deep structures must be rejected on the basis of some constraint stated in terms of deep structure, not in terms of transformational operations.

The gravity of the two problems connected with deriving sentences like (6.158) from structures like (6.159) -- namely the fact that if it is a chopping rule that is involved in the conversion it is not subject to the constraints, and the fact that such sentences as those in (4.149) seem only to be excludable if structures like (6.159) are also excluded as deep structures -- suggests that this derivation must be wrong, and that another source must be found for appositive clauses.

At present, the only solution that comes to my mind is a very radical one. Since it appears that there must be rules of some kind which convert one sentence into two (how else can the second sentence in (4.90a) be derived than from a conjunct?), it may be that there are also some rules which reverse the process. That is, it may be that the source for (6.158) is the sequence of structures underlying the sentences in (6.160).

(6.160) Is even Clarence a swinger? Clarence
is wearing mauve socks.

If this analysis is adopted, it will still be possible to account for the fact that the sentences of (4.156) are ungrammatical, for the corresponding sentences sequences are also.

(6.161) * $\left. \begin{array}{l} \text{Any} \\ \text{No} \\ \text{Every} \end{array} \right\}$ student is a swinger. He wears
socks.

However, the first argument that appositive clauses come from conjoined structures (i.e., the fact that appositives can be introduced by and) cannot be gotten around in this reanalysis, at least, not in any way I can see at present. I am, therefore, very diffident in proposing this reanalysis. It looks like the best analysis of appositives that is presently available, but one which is none too good.

6.2.4.2. There is only one other chopping rule that I know of which in any way provides counterevidence to (6.142). This is the rule of There Replacement. It seems reasonable to assume that after the rule of There Insertion has converted (6.162a) into (6.162b), some rule should operate on the structure underlying this latter sentence to convert it into the structure which underlies (6.162c), by substituting some NP for the derived subject, there.

- (6.162) a. Seven pine trees are behind that barn.
 b. There are seven pine trees behind that barn.
 c. That barn has seven pine trees behind it.²²

There are two arguments which support this analysis. The first is that just as the rule of There Insertion requires an indefinite subject NP to apply (cf. the strangeness of (6.162b) if the is inserted before seven, and the ungrammaticality of (6.163b)),

- (6.163) a. There will be a hole in Jack's pocket.
 b.* There will be the hole in Jack's pocket.

so sentences like (6.162c) require the object of have to be indefinite. Thus if the precedes seven, (6.162c) is as odd as (6.162b), and the sentences in (6.164) parallel exactly those in (6.163), from which they are derived.

- (6.164) a. Jack will have a hole in his pocket.
 b.* Jack will have the hole in his pocket.

The second argument has to do with the fact that such sentences as (6.162c), while they cannot contain reflexives (cf. (6.165a)), must contain a pro-form of the subject NP as the object of the preposition (cf. the ungrammaticality of (6.165b) and (6.165c)).

- (6.165) a.* That barn has seven pine trees behind
 itself.
 b.* That barn has seven pine trees behind the
 cow.

c.* Jack will have a hole in my pocket.²³

That the rule of There Replacement must have a variable in its structural index was pointed out to me by Mary Bremer: not only can the structure underlying (6.163a) be converted into that underlying (6.164a), but also into the one underlying (6.166).

(6.166) Jack's pocket will have a hole in it.

And the structure underlying (6.167) can eventually become any one of the sentences of (6.168), all of which I believe to be fully grammatical, but some of which are rendered unacceptable by an output condition.

(6.167) ?? There is a hole in John's quilt's upper right-hand corner.

(6.168) a.?? John's quilt's upper right-hand corner has a hole in it.

b. John's quilt has a hole in its upper right-hand corner.

c.?? John has a hole in his quilt's upper right-hand corner.

d. John has a hole in the upper right-hand corner of his quilt.

Notice that since the rule of There Replacement substitutes some NP for the derived subject there, it is a chopping rule, by definition (6.138). We would therefore expect it to obey the CNPC, the CSC, and the LBC (I have as yet not been able to construct examples

to show it to be subject to the SSC). The fact that (6.169a) cannot be converted into (6.169b) or (6.169c) shows it to be subject to the CSC,

- (6.169) a. There are seven holes in the door and window.
- b. * The door has seven holes in it and the window.
- c. * The window has seven holes in the door and it.

but the fact that (6.163a) can be converted into (6.164a), and that (6.167) can be converted into (6.168c) and (6.168d) shows this rule not to obey the LBC. To complicate things, however, if the possessive NP is an inalienable possessor, the rule apparently is subject to the LBC: (6.170a) cannot be transformed into (6.170b), though it may be transformed into (6.170c).

- (6.170) a. There is a blemish on the end of Jerry's sister's nose.
- b. * Jerry has a blemish on the end of his sister's nose.
- c. Jerry's sister has a blemish on the end of her nose.

It seems to be the case that only animate NP can be copied out of complex NP's. Thus while the sentences in (6.171) can be transformed into those in (6.172), those in (6.173) cannot be

transformed into those in (6.174).

- (6.171) a. There is a hole in the rug which Toby bought in Butte.
- b. There was an error in the proof Prof. Hiatus presented.
- c. There was a snake behind the car Fred was sitting in.
- (6.172) a. ? Toby has a hole in the rug which $\left. \begin{array}{l} \text{he} \\ *Mike \end{array} \right\}$ bought in Butte.
- b. Prof. Hiatus had an error in the proof $\left. \begin{array}{l} \text{he} \\ *Sarah \end{array} \right\}$ presented.
- c. Fred had a snake behind the car $\left. \begin{array}{l} \text{he} \\ \text{Joe} \end{array} \right\}$ was sitting in.²⁴
- (6.173) a. There was a yellow collar on the dog which the car injured.
- b. There's a hole in the tarpaulin which that stone is holding down.
- c. There was a snake behind the car the time bomb was sitting in.
- (6.174) a. * The car had a yellow collar on the dog which it injured.
- b. * That stone has a hole in the tarpaulin which it is holding down.
- c. * The time bomb had a snake behind the car which it was sitting in.²⁵

Not only does this rule unexpectedly fail to obey the CNPC and the LBC under certain conditions, it also appears to obey stronger constraints. Thus while the boxed NP in (6.175a) can be relativized (cf. (6.175c)), it cannot be substituted for there, as (6.175c) shows.

- (6.175) a. There were several hundred people yelling for me to put the hot potato down gently.
- b. The hot potato which there were several hundred people yelling for me to put down gently turned out to have been filled with TNT.
- c. * The hot potato had several hundred people yelling for me to put it down gently.

6.2.5. Except for the two rules discussed in § 6.2.4 I know of no chopping rule that does not obey all the constraints of Chapter 4. And I know of no copying rule which does obey them. Thus the distinction made in (6.138) appears to have a basis in linguistic fact, as long as there are so many unresolved problems in the analysis of the two constructions discussed in § 6.2.4. I will provisionally assume, therefore, that the generalization stated in (6.142) is correct.

6.3. Reordering over Variables

6.3.1. In § 4.2.3 above, I discussed the rule proposed in

Lakoff and Peters (1966) which I will refer to as Conjunct Movement.

It is stated approximately as in (6.176).

(6.176) Conjunct Movement²⁶

[NP - [and NP] _{NP} -] _{NP}	VP	
1	2	3 \longrightarrow
1	0	3#2

This rule must apply to (6.177), which underlies (6.178a), to move the circled NP along the path shown by the arrow, eventually producing (6.178b).

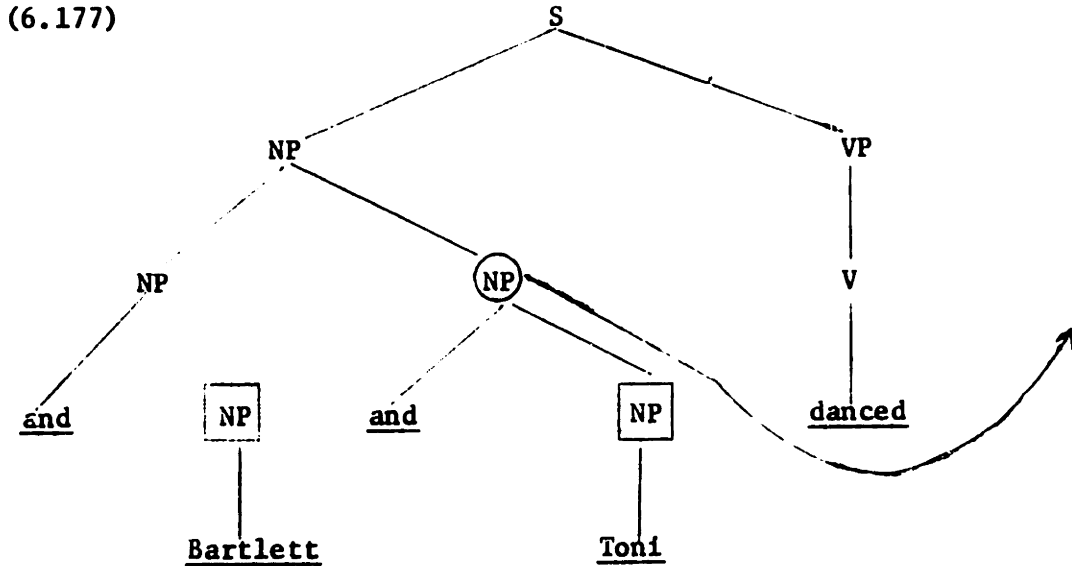

- (6.178) a. Bartlett and Toni danced.
 b. Bartlett danced with Toni.

But as I pointed out in footnote 13 of Chapter 4, as the CSC is presently stated, such an operation is impossible, for

Conjunct Movement is a chopping rule, and the subject NP of (6.178a) is a coordinate node.

It is not possible to claim that somehow this particular subject NP is not affected by the CSC, for it is impossible to move either boxed NP to the end of (6.177) by the rule of NP Shift, (5.57), as is shown by the ungrammaticality of (6.179).

(6.179) a. * Bartlett and danced Toni.

b. * (And (and)) Toni danced Bartlett.

Since it is not this particular construction that is exempt from the CSC, it must be some feature of the rule. The operation of the two rules of Conjunct Movement and NP Shift is virtually the same -- in each, some NP gets moved to the end of a sentence. But there is a significant difference in the statement of the rules; while the latter rule permutes to the end of the first sentence up any NP (because term 2 of (5.57) is surrounded by variables), the former rule specifies that the second conjunct of the conjoined subject NP may be moved to the end of its VP.

In other words, the first rule makes crucial use of variables, while the second does not. At present, I believe it to be the case that the constraints of Chapter 4 never affect any rule unless that rule reorders one of its terms around a variable. This generalization is stated in (6.180).

(6.180) Only rules in which terms are reordered around variables are subject to the constraints of Chapter 4.

In the case just discussed, it is possible to imagine an alternative solution involving rule ordering. Thus it could be argued that if either the first and of (6.177) has been deleted, or if the second has been converted into a preposition, the subject node of (6.178a) would no longer be coordinate, so the CSC would not be in effect any longer. But if this is the correct explanation, it must be possible to order the rule of NP Shift early, so that it precedes all these changes, and I do not know whether such an ordering can be maintained.

However, even if such an analysis can be carried through for English, there are languages, like Japanese, where the conjunction is not rewritten as a preposition by the rule which corresponds to (6.176), so such an explanation will not be possible in general. And there are two additional cases, from English, which seem to require the generalization stated in (6.180). These will be presented immediately below.

6.3.2. In sentence (6.181), the NP her cannot be relativized, as (6.182) shows.

(6.181) It bothers me for her to wear that old fedora.

(6.182) a. * The only girl for whom it bothers me to wear that old fedora is Annabelle.

b. * The only girl who it bothers me (for) to wear that old fedora is Annabelle.

It is not the case that no element of an extraposed for - to phrase can be chopped, as (4.273) shows. It therefore seems to be necessary to add (6.183) to the conditions box for English.

(6.183) No element in the environment [for — VP] can be chopped.

But now consider the rule of It Replacement, which was discussed in § 5.1.1.1. The formal statement of this rule, which raises interesting theoretical problems which I will not take up here (they are discussed briefly in Lakoff (1966)), contains as a subpart the rule shown in (6.184).

(6.184) X - [it [_S { for / Poss } - NP - VP] _S] _{NP} Y

1	2	3	4	5	⇒⇒⇒
1	4	3	0	5	

This rule will convert the structure underlying (6.185a) into the one underlying (6.185b).

(6.185) a. I would prefer it for there to be no talking.

b. I would prefer there to be no talking.

Notice that the boxed NP of (6.185a), even though it is in the environment which is specified in (6.183), has been chopped by rule (6.184). Once again, however, there is a contrast in the formal statement of the rules in question. The rule of Relative Clause Formation, which is subject to (6.183), as the ungrammaticality of (6.182) shows, permutes the relativized NP around a variable, while in (6.184), the chopped term merely moves over the constants in term 3. Thus the fact that (6.185b) is grammatical, and (6.182) ungrammatical, provides further evidence for the correctness of (6.180).

6.3.3. In § 3.1.1.3.1. above, I pointed out that it was necessary to constrain the rule of NP Shift somehow, so that sentences like (3.20b), (3.35b), and (3.36b) would not be generated. But the condition I stated there, (3.34), can be generalized, for while the underlined NP in (6.186a) can be questioned (cf. (6.187a)), if the indirect object precedes the direct object, as in (6.186b), the indirect object cannot be questioned (cf. (6.187b)).

(6.186) a. He gave my binoculars to that girl.

b. He gave that girl my binoculars.

- (6.187) a. Which girl did he give my binoculars to?
 b. * Which girl did he give my binoculars?²⁷

Since it is not universally the case that indirect objects cannot be chopped (for instance, in German the sentence Welchem Mädchen gab er meinen Feldstecher?, which translates (6.187b), is grammatical), it would appear that some condition like that stated in (6.188) must appear in the conditions box for English.

- (6.188) No element may be chopped out of the environment [NP V __ NP]_S, unless the following NP begins with a preposition.

However, if this condition is correct, how can both versions of (6.186) be passivized, as the grammaticality of the sentences in (6.189) indicates is necessary?

- (6.189) a. My binoculars were given to that girl by him.
 b. That girl was given my binoculars by him.

The answer is obvious: since all reordering rules which are subject to (6.188) make crucial use of variables, while the Passive Rule, however it is to be stated, need not do so, if the generalization expressed in (6.180) is added to the theory of grammar, the contrast between (6.187) and (6.189) can be naturally accounted for. Therefore, on the basis of these facts, and the evidence presented in §§ 6.3.1 - 6.3.2, I tentatively propose the addition of (6.180) to the theory of grammar.

6.4. Islands

6.4.0. The fundamental insight of this section is due to Paul Kiparsky. In connection with some extremely important, but still unpublished, research on complement constructions which he is conducting, he pointed out that the that-clause in (6.190a) has a factive meaning, while this is not the case in (6.190b).

- (6.190) a. Bill confirmed that Roger has eaten
the cake
- b. Bill alleged that Roger $\left. \begin{array}{l} \text{had} \\ \text{??has} \end{array} \right\}$ eaten
the cake

One who utters (6.190a) is not only reporting an action of Bill's, he is himself asserting that the content of the that-clause is true. This is not the case with (6.190b) -- there the speaker merely comments on Bill's action, without himself taking any stand on the truth of the embedded sentence. One of the many ways that Kiparsky has discovered this semantic difference to be paralleled by syntactic differences is in the behavior of elements of the two kinds of that-clauses under chopping rules. Thus while the boxed NP in (6.190b) can be questioned (cf. (6.191b)), the boxed NP of (6.190a) can only be questioned with difficulty, if at all, (cf. (6.191a)).

- (6.191) a.?? What did Bill confirm that Roger had
 eaten?

- b. What did Bill allege that Roger had eaten?

For the purposes of the present discussion, Kiparsky's most important observation was that the restrictions on a feature-changing rule like Indefinite Attraction, (5.71), exactly parallel those on the rule of Question, a chopping rule.

- (6.192) a.?* Bill didn't confirm that Roger had eaten anything.
- b. Bill didn't allege that Roger had eaten anything.

These facts can be generalized trivially, to yield the hypothesis in (6.193).

- (6.193) All feature-changing rules obey the same constraints as chopping rules.

The rest of § 6.4 is devoted to exploring the consequences of this hypothesis. In § 6.4.1, I will discuss a few of the many pieces of confirming evidence that I know of, and in § 6.4.2, I will discuss all the disconfirming evidence that has come to light thus far. Finally, in § 6.4.3, I will examine the converse of (6.193) and define the concept island.

6.4.1.

6.4.1.0. This section is divided into four parts. In the first three, I will show how various feature-changing rules are subject to

the CNPC, the CSC, and the SSC, respectively, and in the fourth, I will show how various restrictions on chopping rules which appear in the conditions boxes of a number of languages also affect the operations of feature-changing rules.

6.4.1.1. If the rule of Indefinite Incorporation, (5.71), is subject to the CNPC, the contrast between the sentences of (6.194) is accounted for (cf. also (5.73e)).

(6.194) Waldo didn't report (* the possibility)
that anyone had left.

The CNPC also correctly predicts that sentences like (5.73f), where rule (5.71) has gone down into a relative clause, are ungrammatical.

There are, however, relative clauses which can contain words like any, ever, and at all, which typically occur in environments where rule (5.71) operates. The sentences in (6.195) are a representative sample of such clauses.

- (6.195) a. Nobody who hates to eat anything should
work in a delicatessen.
- b. Anybody who ever swears at me better
watch his step.
- c. Everybody around here who ever buys
anything on credit talks in his sleep.
- d. I want all the students who have ever
tried to pat Macavity to show me their scars.

- a. $\left. \begin{array}{l} \text{The only} \\ \text{*Only the} \end{array} \right\} \text{travelers who anybody has}$
 ever robbed don't carry machetes.

What seems to be going on here is that indeterminates can become indefinites in a relative clause which modifies an NP whose determiner belongs to the set no, any, a, every, all, the first (but not the second, third, etc.) the last, the Adj. & est (cf. the best steak I ever ate) the only (but not only the), etc., whether or not the sentence containing the clause is negated. That this rule cannot be the same as (5.71) is indicated by the following facts.

The word any cannot appear in the relative clause of (6.196), because the determiner some of the NP this clause modifies is not one of the set mentioned above.

- (6.196) * I can't remember the name of somebody who had (*any) misgivings.

But if the boxed [+Affective] element of (6.196) has triggered the change of the boxed some to any, then the environment for the rule which allows indefinites to appear in relative clauses will be met, and this rule can go down into the relative clause, as has happened in (6.197).

- (6.197) I can't remember the name of anybody who had any misgivings.

It is therefore evident, since the rule in question must follow (5.71), that the two rules cannot be collapsed into one.

Incidentally, sentence (6.198) shows that this rule must be able to apply to its own output, in a rather interesting way.

(6.198) Everybody who has ever₁ worked in any₁ office which contained any₂ typewriter which had ever₃ been used to type any₃ letters which had to be signed by any₄ administrator who ever₅ worked in any₅ department like mine will know what I mean.

The element which allows the presence of all the any's and ever's in this sentence is the boxed determiner every. The first time the rule in question applies to the structure underlying (6.198), it will produce ever₁ and any₁. But now, the result of this first application, the determiner any₁, provides a new environment for the rule to reapply in (recall that this rule could not have gone down into a relative clause on an NP whose determiner was some (cf. (6.196))). The rule must then be able to produce any₂ on its second application, and this any will provide yet a third environment for the rule to reapply in, and so on down the tree. This is the only rule I know of which applies in this "anti-cyclic" way, eating its way from higher sentences into lower ones, in sequence, so to speak, instead of the normal type of rules, which process embedded sentences first, and then the sentences that contain them. This rule is therefore eminently worthy of very detailed investigation, which would be

For it is possible, as George Lakoff has pointed out to me, for elements to be moved out of the complex NP's sentence, as long as they stay within the NP itself (cf., e.g., rule (4.135)). To say that a feature-changing rule obeys the CNPC is to say that no element not dominated by a complex NP can effect changes in the sentence dominated by that NP. Thus the determiners under discussion, since they are dominated by the NP, can cause the introduction of the feature [+ Indefinite] into a relative clause, as is the case in (6.195), while [+ Affective] elements which are outside the NP cannot.

There are two other sets of facts which can be accounted for readily if the hypothesis stated in (6.193) is correct. In § 3.1.3 above, I pointed out that the Case Marking Rule must be restricted so that no elements of relative clauses are assigned the case of the head NP, and I stated an ad hoc condition (in which subscripts had to be used) to this effect on rule (3.58). However, once it has been stated in (6.193) that all feature-changing rules like (3.58) are subject to the CNPC, no restriction need be stated on rule (3.58).

Similarly, in § 4.1.6, I claimed that it was universally true that reflexives do not go down into relative clauses. I know of only one language, Japanese, which contradicts this generalization (the Japanese rule of Reflexivization will be investigated briefly in § 6.4.2 below), so though the generalization must be reformulated in a weaker way, it appears to contain an important truth, a truth

which can be explained if Reflexivization is subject to the CNPC. I hope that it will turn out to be the case that if there are other languages whose rules of reflexivization can go down into complex NP, it will be possible to point to some formal property shared by all such languages, on which this unusual behavior can be made to depend. At present, however, this is no more than a hope, so the Japanese facts constitute clear counterevidence for (6.193).

6.4.1.2. To see that rule (5.71) is subject to the CSC, it is sufficient to observe that the boxed some of (6.200) cannot be converted into any if (6.200) is negated: while (6.201a) is possible, (6.201b) is not.

(6.200) I ate the ice cream and some cake.

(6.201) a. ? I didn't eat the ice cream and some
cake.

b. * I didn't eat the ice cream and any
cake.

Similar facts obtain for sentence (6.202): if negated, as in (6.203a), the boxed some of the second conjunct cannot be converted into any.

(6.202) I realized that it had rained and some
crops had been destroyed.

(6.203) a. I didn't realize that it had rained and
some crops had been destroyed.

b. * I didn't realize that it had rained and
any crops had been destroyed.

Interestingly, there appears to be a phenomenon here which is reminiscent of the "across-the-board" rules that were discussed in § 4.2.4.1 above. Thus indefinites can appear in conjuncts if they are conjoined with or, instead of and, as in (6.204).

(6.204) I didn't eat any ice cream $\left\{ \begin{array}{l} \text{or} \\ * \text{and} \end{array} \right\}$ any
cake.

It seems to me that such sentences as those in (6.205), where indefinites appear only in one conjunct, are all ungrammatical in varying degrees, but I am not sure of this intuition.

(6.205) I didn't eat $\left\{ \begin{array}{l} * \text{ any ice cream or } \left\{ \begin{array}{l} \text{Mary's} \\ \text{the} \end{array} \right\} \text{ cake} \\ ? * \text{ the cake or any ice cream} \\ ? \text{ Mary's cake or any ice cream} \end{array} \right\}.$

Even if it should prove to be correct that some kind of across-the-board constraint is operative here, I can see no way of accounting for the differences between the sentences of (6.205), or for the fact that only or can appear in such sentences as (6.204) and (6.205). Clearly a great deal of further research is needed here.

The CSC appears to restrict feature-changing rules not only in that the feature [+ Indefinite] cannot go down into a conjunct, but also in that the [- Affective] element which broadcasts the [+ Indefinite] features cannot be in a conjunct. In Lakoff and Peters (op. cit.), (6.206a) and (6.206b) are derived from the same underlying structure, the only difference being that in the derivation of (6.206b), two rules have applied which do not apply in the derivation of the more basic (6.206a) -- the rule of Conjunct Movement, (6.176), and a rule which deletes the preposition with which was originally in front of the superficial object Maxime.

- (6.206) a. Gottlob and Maxime met in Vienna.
 b. Gottlob met Maxime in Vienna.

Now note that if the determiner few appears in a conjunct of such a conjoined NP subject, rule (5.71) cannot introduce the feature [+Indefinite] into the second conjunct (cf. the ungrammaticality of (6.207a)), but that if the rule of Conjunct Movement has applied, to break up the coordinate structure, the moved conjunct can be converted into an indefinite (cf. (6.207b)).

- (6.207) a. * Few writers and any playwrights meet
 in Vienna.
 b. Few writers meet any playwrights in
 Vienna.

The situation seems to be a great deal more complicated than the above facts would indicate, however. So note that (6.207a) is not improved by replacing any with some, as might be expected. And while (6.208a) is ungrammatical, (6.208b) is grammatical.

(6.208) a. * My brother and few Americans meet in Vienna.

b. My brother meets few Americans in Vienna.

Also, while (6.209a) is grammatical, (6.209b) is not.

(6.209) a. No writer, $\left. \begin{array}{l} \text{and no} \\ \text{nor any} \end{array} \right\}$ playwright, speaks clearly.

b. * No writer, $\left. \begin{array}{l} \text{and no} \\ \text{nor any} \end{array} \right\}$ playwright, meets in Vienna.

These sentences raise so many problems that I can only call attention to them here -- I have no idea what processes are at work.

That the Reflexivization Rule is subject to the CSC is immediately apparent from the sentences in (6.210).

(6.210) a. Bill understands $\left. \begin{array}{l} * \text{ Mary and himself} \\ ?* \text{ himself and Mary} \end{array} \right\}$.

b. * Bill and Mary washed himself.

c. * Andy pinched Sarah and tickled herself.

d. * The gun and a description of itself lay on the bureau.

A particularly clear example is provided by (6.211), whose underlying structure is that shown in (6.212).

(6.211) Bill believes that Anna and he are similar.

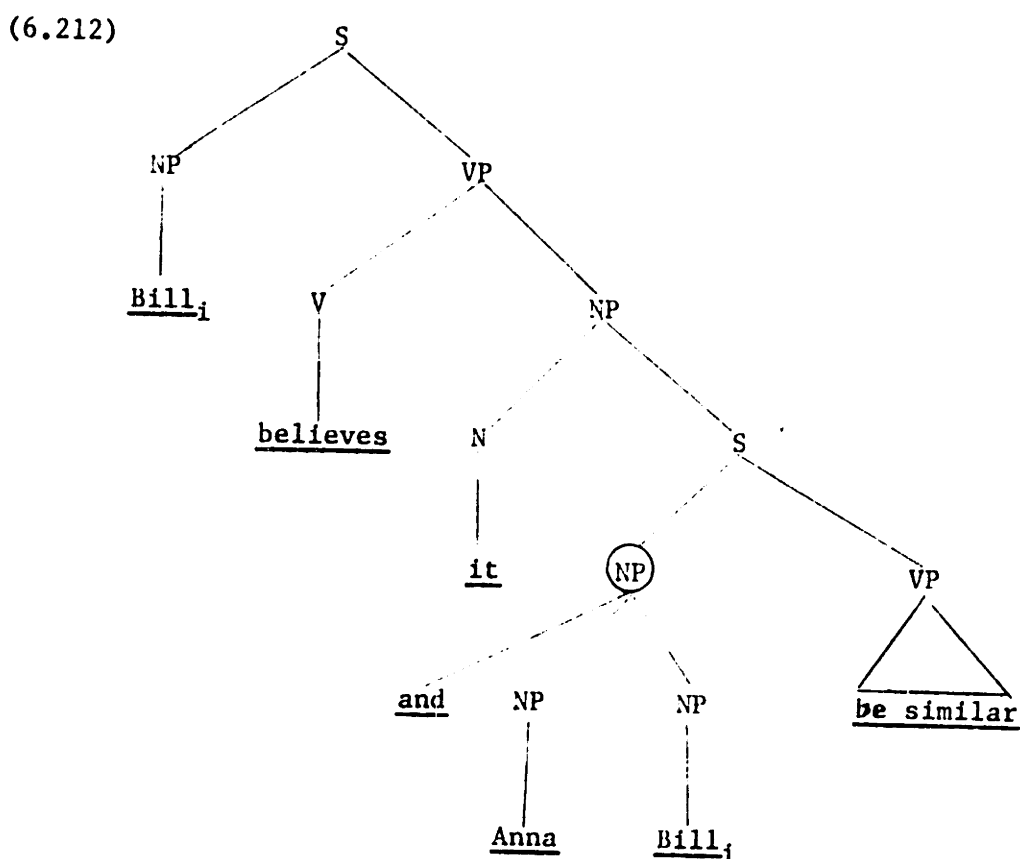

If the rule of It Replacement does not apply, this structure will undergo various rules, and will finally emerge as the grammatical (6.211). If It Replacement does apply, however, and the circled NP has been substituted for it in (6.212), it would

be expected that the leftmost occurrence of Bill₁ would be able to reflexivize the right-most occurrence, for each commands the other. That this does not happen (cf. the ungrammatical version of (6.213)) is explained if the CSC also constrains feature-changing rules.

(6.213) Bill believes Anna and ^{him} ~~*himself~~ to be similar.

6.4.1.3. I believe it to be the case that feature-changing rules are also subject to the SSC, but the pieces of evidence I have been able to find to support this claim are based on very delicate intuitions, and these may not be shared. For instance, I believe it to be true that while Indefinite Incorporation can go down into that-clauses, it cannot go down into them if they are in subject position. Thus (6.214a) is ungrammatical, and (6.214b), where the embedded subject clause has been extraposed, is grammatical.

(6.214) a. * I deny that that McIntyre has any money is certain.

b. I deny that it is certain that McIntyre has any money.

The problem is this: since the underlined phrase in (6.214a) is a sentence which is dominated exhaustively by NP,

output condition (3.27) will lower the acceptability of (6.214a). Does, therefore, the fact that rule (5.71) has applied to produce the boxed any in this sentence contribute to its unacceptability? The answer to this question will lie in a comparison of (6.214a) and (6.215), which is identical to the former sentence except for the fact that any has been replaced by some.

(6.215) ?? I deny that that McIntyre has some
money is certain.

I myself find a clear, if small, difference between (6.214a) and (6.215): while both are unacceptable, I would judge the former to be ungrammatical in addition. If these are the correct facts, it is to the SSC that the difference between (6.214a) and (6.215) must be attributed.

The second set of facts that seem to indicate that a feature-changing rule is subject to the SSC has to do with Klima's rule of Negative Incorporation (cf. Klima (op. cit.)), which can optionally convert the structure underlying (6.216a) into the one which underlies (6.216b),

(6.216) a. Tom will not force you to marry any
student.

b. Tom will force you to marry no student.

and which obligatorily converts the structure underlying (6.217a) into the one underlying (6.217b).

(6.217) a. * The writers of any of the reports
didn't know the answer.

b. The writers of none of the reports
knew the answer.

Klíma supports his claim that (6.216b) and (6.217b) are instances of sentence negation by showing that both may be followed by neither-tags, as in (6.218),

(6.218) a. Tom will force you to marry no student,
and neither will I.

b. The writers of none of the reports
knew the answer, and neither did the
writers of any of the chronicles.

a property which he demonstrates elsewhere in the article to be restricted to sentences whose main verb is negated.

Since both (6.216b) and (6.217b) are grammatical, the rule of Negative Incorporation must be able to operate forward and backward. And since it can operate forward into an extraposed clause, changing (6.219a) into (6.219b),

(6.219) a. It is not certain that you'll marry any
(particular) student.

b. It is certain that you'll marry no
student.

the fact that it cannot, if my intuitions are correct, operate backwards into a subject clause ((6.220a) cannot become (6.220b)),

requires explanation.

- (6.220) a. That you will marry any (particular)
student is not certain.
- b. * That you will marry no student is
certain.²⁸

The fact that the SSC can block (6.220b), if the rule of Negative Incorporation is formulated as a feature-changing rule,²⁹ thus provides further support for the hypothesis that all feature-changing rules obey the same constraints as chopping rules.

6.4.1.4. In § 5.1.3.2.3, in connection with the sentences in (5.103), I pointed out that the Russian rule of Reflexivization, (5.98), could not go down into clauses headed by the word što 'that'. But it is necessary in any case to state in the Russian conditions box that no elements of što-clauses can be chopped out of these clauses. For instance, the NP ženščinu 'woman' in (6.221) cannot be relativized, as the ungrammaticality of (6.222) shows.

- (6.221) ja znal što on ljubil ženščinu.
'I knew that he loved the woman.'
- (6.222) * vot ženščina kotoruju ja znal
here is the woman who I knew
što on ljubil.
that he loved.

Since some condition must be stated in the grammar of Russian in any case, so that (6.122) will not be generated, if the hypothesis in (6.193) is adopted as a principle of the theory of language, the ungrammaticality of (5.103b) can be explained. The fact that the rule of Russian Genitive Introduction, (5.92), also does not go down into što-clauses (cf. the sentences in (6.223)),

(6.223) a. ja ne znal što on eto sdelal.

I not know that he this (acc.) did

'I didn't know that he did this.'

b. * ja ne znal što on etovo sdelal.

I not know that he this (gen.) did

is of course to be explained on exactly the same basis. Similarly, it can be shown that the two Finnish rules which were discussed in § 5.1.3.2. -- the rules of Finnish Partitive Introduction, (5.85), and Finnish Nominative Introduction, (5.108), also do not go down into clauses headed by että 'that', a fact that can be explained on the basis of hypothesis (6.193) and the restriction in the Finnish conditions box that no elements can be chopped out of että-clauses (cf. the ungrammaticality of (4.249b)).

Finally, if (6.193) is in the theory of grammar, the fact, noted in § 4.1.6 above, that there is a parallelism between the relativizability of elements after picture nouns and their

reflexivizability (cf., e.g., the parallelism between (6.224) and (6.225)),

(6.224) The man who I gave John $\left. \begin{array}{c} a \\ ??\text{this} \\ *\text{Ed}'\text{s} \end{array} \right\}$ picture
of was bald.

(6.225) I gave Jack $\left. \begin{array}{c} a \\ ??\text{this} \\ *\text{Ed}'\text{s} \end{array} \right\}$ picture of myself.

can be explained, and the correct prediction can be made that other feature-changing rules will be subject to the same curious constraints involving the determiners of picture nouns (cf. (6.226)).

(6.226) I didn't give Jack $\left. \begin{array}{c} a \\ *\text{this} \\ *\text{Ed}'\text{s} \end{array} \right\}$ picture of
anybody.³⁰

6.4.2. While the facts presented in § 6.4.1 provide very strong evidence that (6.193) is correct, there are still some puzzling countercases. Thus while (6.193) would predict that no features of NP's which are on the left branch of larger NP's could be changed, this in fact can happen, as (6.227) indicates.

(6.227) I hope I'm not treading on anyone's
toes.

In Japanese, it appears to be possible to violate at least the CNPC, with respect to the rule of Reflexivization. Thus the boxed NP of tree (6.231), which underlies (6.232), can be reflexivized, yielding (6.233).

(6.231)

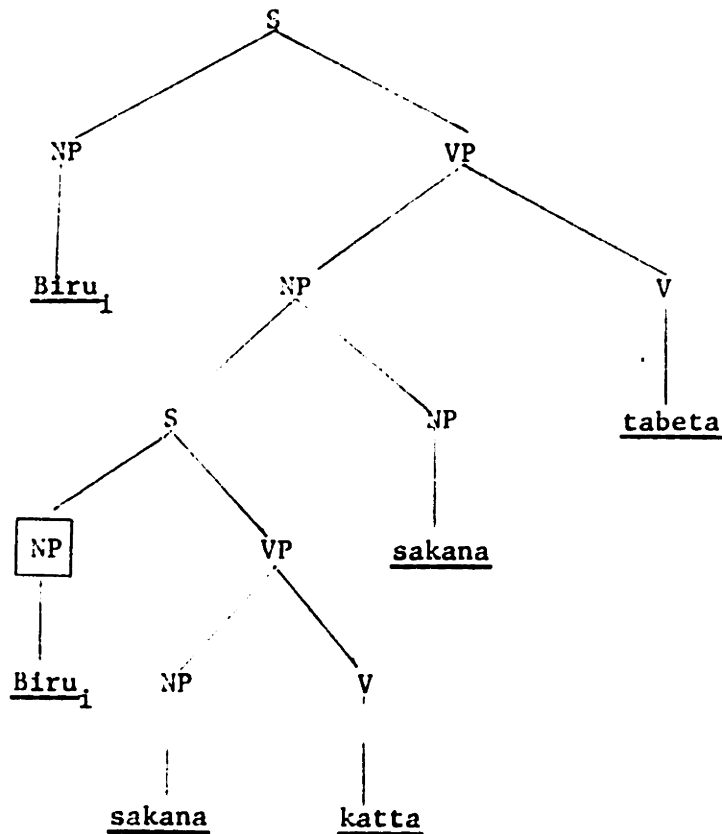

(6.232) $Biru_i$ wa $kare_i$ ga katta sakana o tabeta.
 Bill he bought fish ate
 'Bill ate the fish he bought.'

(6.233) $Biru_i$ wa $zibun_i$ ga katta sakana o tabeta.
 'Bill self bought fish ate.'

The same situation appears to obtain with respect to sentences in apposition to sentential nouns like syutyoo 'claim'. Thus in (6.234), either the reflexive pronoun zibun 'self' or the third person non-reflexive pronoun kare 'he, she, it' can be used to refer back to the subject of the sentence, Biru 'Bill'.

(6.234) $\text{Biru}_i \text{ wa } \left\{ \begin{array}{l} \text{kare}_i \\ \text{zibun}_i \end{array} \right\} \text{ ga kono sakana o}$
 $\text{Bill} \quad \left\{ \begin{array}{l} \text{he} \\ \text{self} \end{array} \right\} \quad \text{this fish}$

katta to iu syutyoo o sinzita.
 bought that say claim believed.
 'Bill believed the claim that he had
 bought the fish.'

I do not know what the facts are in Japanese with respect to whether Reflexivization can violate the CSC, but if it can, the obvious conclusion is that (6.193) cannot be universal, and that particular grammars must designate in their conditions boxes whether (6.193) is operative in the language or not. That is, (6.193) would be a language-particular "option".

Whatever the outcome of the investigation of the question as to whether (6.193) is a universal condition (which now seems unlikely), or an option, it seems reasonably clear that it is operative in English.

In the next section, I will investigate the consequences of assuming the converse of (6.193) also to be operative in English.

6.4.3.

6.4.3.1. The converse of (6.193) is stated in (6.235):

(6.235) All chopping rules obey the same constraints as feature-changing rules.

The only constraint that I know to hold for all feature-changing rules is the one which was stated in (5.77), and then restated in (5.122) in terms of command: if an element A in a phrase marker is to have the feature $[+ F]$ added to it, the element(s) which triggers this change must command A.

Graphically, then, (5.122) says that if A, at the bottom of the schematic phrase marker shown in (6.236), is to be changed, then the triggering element must lie within the shaded "strip" of (6.236), for it is only elements of this strip that command A.

(6.236)

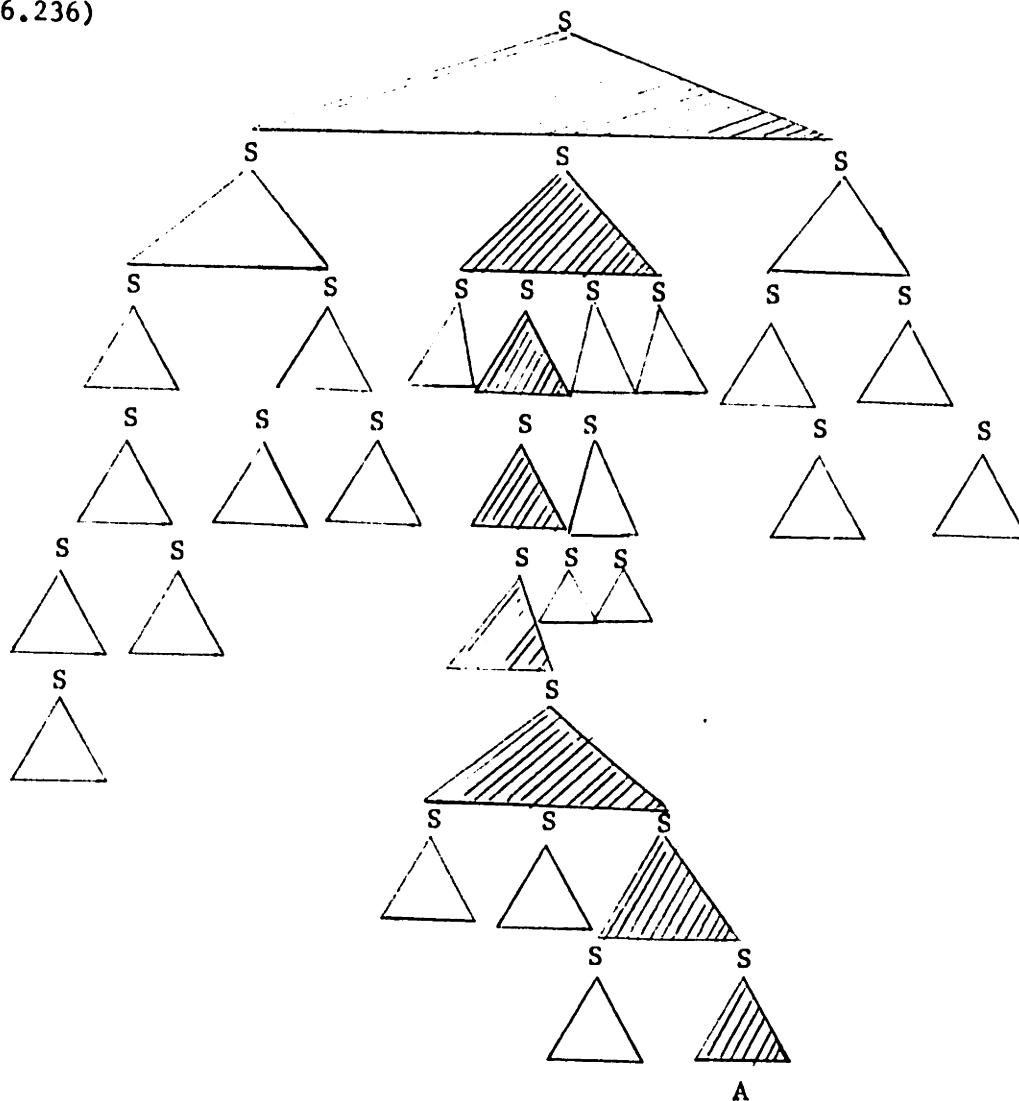

There is an independently motivated principle of derived constituent structure, which restricts reordering transformations in a way highly reminiscent of (5.122): this principle is stated in (6.237).

(6.237) If the structural change of a transformation specifies that one term of the structural index is to be adjoined to a variable, pick the highest proper analysis which the variable allows, and adjoin the term to this string.³²

Instead of attempting a formal definition of the term "highest proper analysis", which would be straightforward, if difficult, I will illustrate the effect this principle has with an example.

Supposing that (6.238a) is converted to (6.238b) by the rule of Adverb Preposing, (5.67).

- (6.238) a. What Bob cooked yesterday still tastes good tonight.
- b. Tonight, what Bob cooked yesterday still tastes good.

If (6.238a) is assumed to have the structure shown in (6.239) (whether (6.239) is correct in all details -- in particular whether the adverb tonight should be dominated by VP, S₁, or by some other node, is not important), then which of the possible derived constituent structures shown in (6.240) should be assigned to (6.238b)?

(6.239)

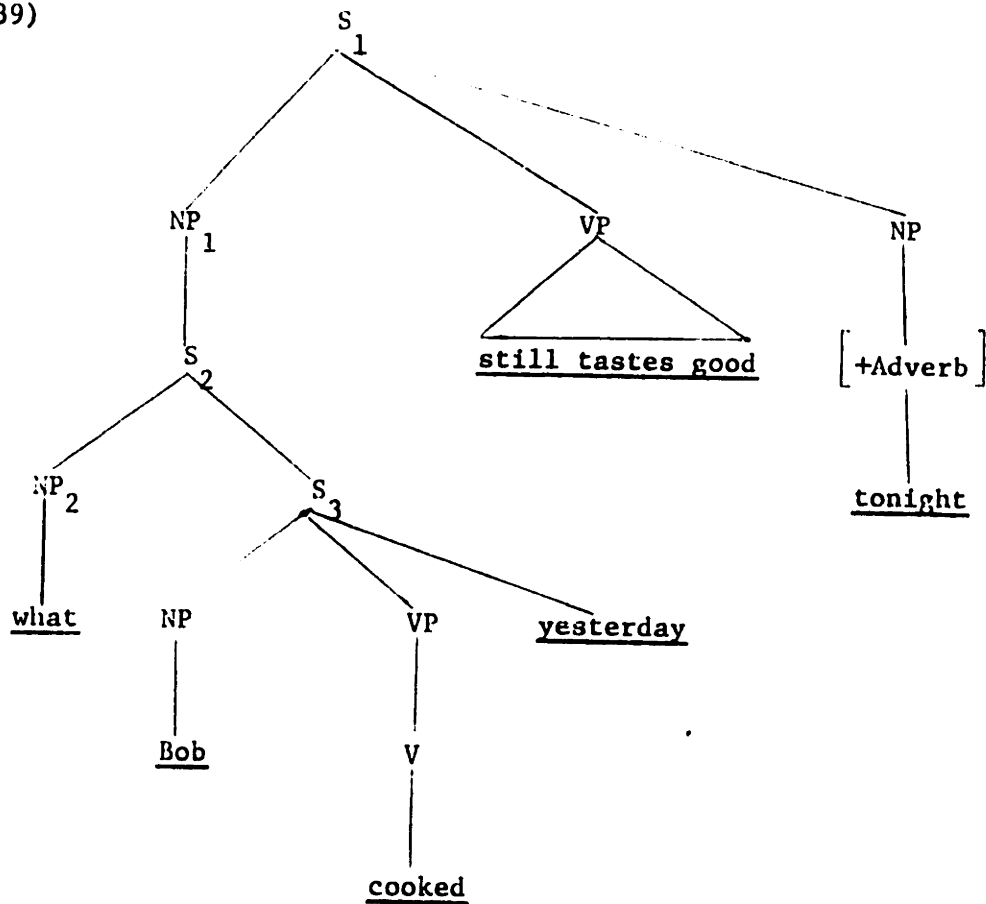

(6.240)

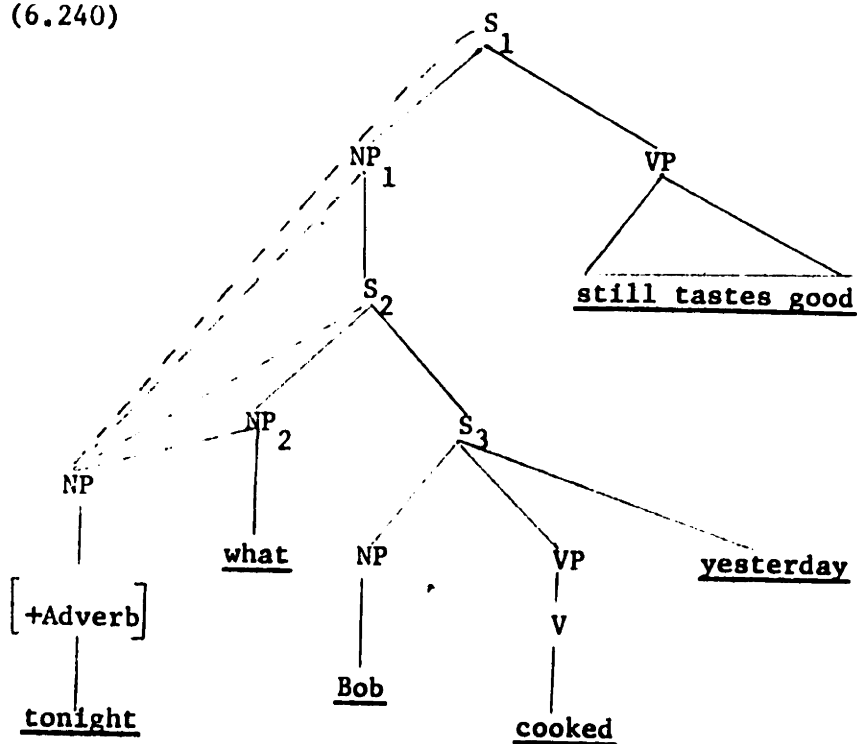

Intuitively, of course, it is clear that the preposed tonight can only be the daughter of S_1 ; if it were dominated by NP_1 or S_2 , the counterintuitive claim would be made that the string tonight what Bob cooked yesterday is a constituent, and if it were dominated by NP_2 , that tonight what is a constituent.

Syntactic evidence is available to show that tonight cannot be immediately dominated by NP_1 , S_2 , or NP_2 . Since Adverb Preposing must precede all rules of pronominalization (cf., e.g., the paradigm in (5.151), where the subject of will go can only be pronominalized if the adverbial if-clause has been preposed by (5.67)), (6.241b) will only be derivable from (6.241a) if the string what Bob cooked yesterday is a constituent, for it is clear that this string is what the it of (6.241b) refers to, and pronominalization is restricted to delete constituents under identity.

- (6.241) a. Tonight, what Bob cooked yesterday
still tastes good, so tonight, what Bob
cooked yesterday will be eaten up.
- b. Tonight, what Bob cooked yesterday still
tastes good, so tonight it will be
eaten up.

If tonight were dominated by S_2 or NP_2 , the string what Bob cooked yesterday would not be a constituent, and if NP_1 dominated tonight, while this string would be a constituent, it would not be

an NP. Since it seems most reasonable to analyze the it of (6.241b) as being a pro-NP, the only place the adverb tonight can be attached is as a sister to NP_1 , connected by the highest dotted line in (6.240) to S_1 . Since principle (6.237) would ensure that this d.c.s., and none of the other counterintuitive possibilities indicated by the other dotted lines of (6.240) would result, there is good reason to believe that (6.237), or its equivalent, must appear in any adequate theory of grammar.

But now note that (6.237) will also ensure that if element A of phrase marker (6.236) is permuted around a variable, it will not move out of its strip. It is of course theoretically possible to state a reordering rule which makes crucial use of variables and which can move an element out of its strip; one such rule is stated in (6.242).

$$(6.242) \quad \left[\begin{array}{c} S \\ \text{NP} - \text{VP} \end{array} \right]_S - X - \text{NP} - Y$$

1	2	3	4	5	⇒
4 +	1	2	3	0	5

This rule could apply to a structure like (6.243a) and convert it to (6.243b), moving the circled NP off its shaded strip in (6.243a).

(6.243) a.

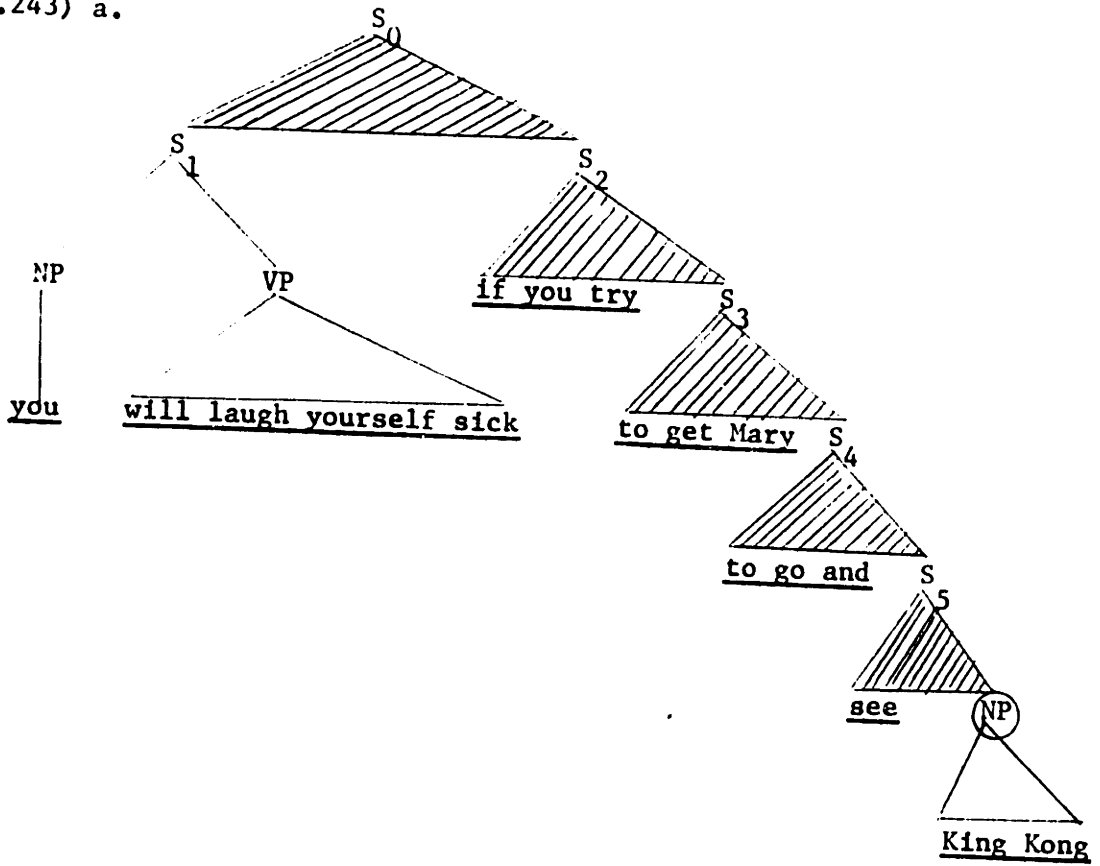

b.

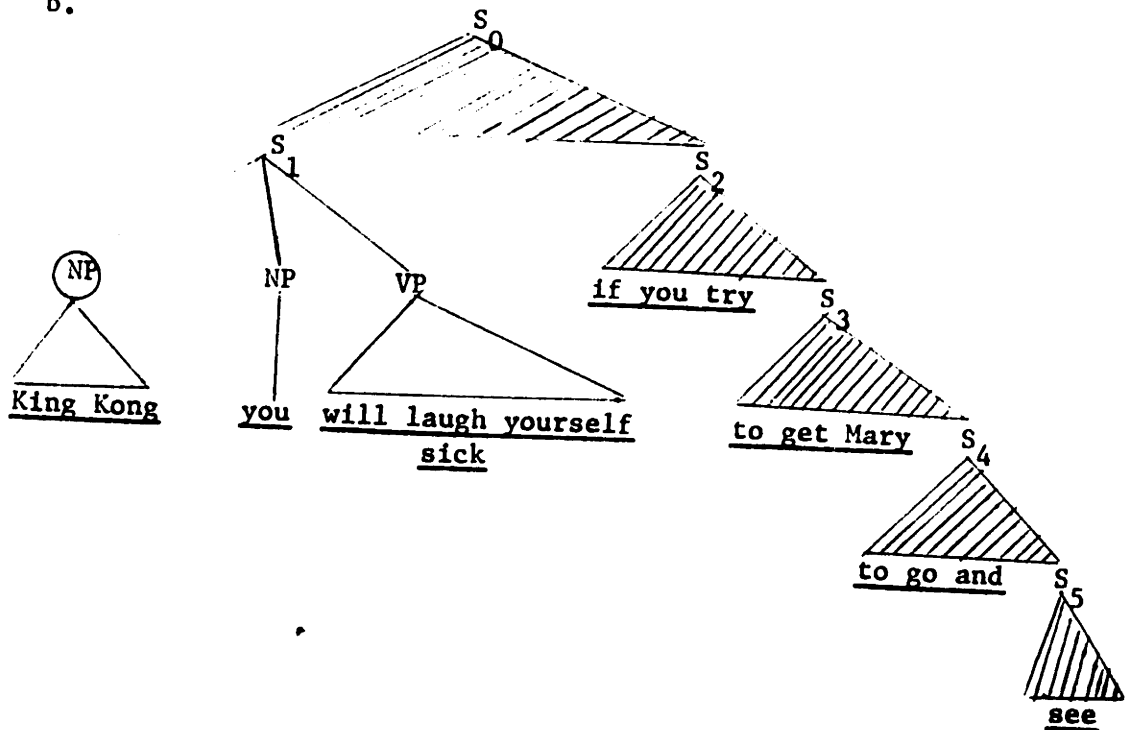

The question is, will the grammar of any natural language ever have to contain such a rule? My present answer to such a question, an answer based on all the rules I know of, is an unequivocal "no". Not only must the "highest proper analysis" principle of (6.237) be stated in the theory of grammar, but some formal constraint must be stated so that rules like (6.242) can never be stated in any grammar. So little is known at present, however, that it is pointless to propose a formal constraint to this effect at the present juncture.

To point up the close conceptual parallels between (5.122) and (6.237), a paraphrase which makes use of command may prove helpful. (5.122) asserts that if the feature $[+ F]$ is added to an element A, the cause of the change commands A (is in the strip above A). (6.237) asserts that if A moves, it will move to a position which commands (is in the strip above) its original position.

Actually, this last paraphrase of (6.237) is inaccurate, for if it is only required that a preposed adverb command its place of departure, the adverb tonight could be attached as the daughter of S_1 or NP_1 in tree (6.240): only if it were to become a daughter of S_2 or NP_2 in (6.240) would it no longer command its point of departure. Thus (6.237) is a stronger condition, for reordering transformations, than (5.122) is for feature-changing transformations.

If we accept both (6.193) and (6.235) as working hypotheses, then, since (6.237) is necessary in any event, as the discussion of (6.238) and (6.241) showed, it should be possible to logically deduce (5.122) from the stronger (6.237). In other words, if the conditions on feature-changing rules are all and only the conditions on reordering rules (but cf. the discussion on Japanese in § 6.4.2), then the asymmetry mentioned at the end of § 5.1.4 above, that while there are upward bounded rules which are downward unbounded, there are no downward bounded, upward unbounded rules, should follow from the "highest analysis" principle of (6.237). Intuitively, (5.122) "feels" the same as (6.237), although I have as yet been unable to construct a rigorous proof, along the lines sketched above, that the former is a consequence of the latter.

6.4.3.2. As I showed in phrase marker (6.236), the converse of the relation command selects for each element A of phrase marker P the maximal strip of A in P . Element A cannot be moved off its maximal strip, nor can any element of P which is not on this strip cause any feature to be added to A . In other words, the maximal strip of A is the maximal domain of application for all chopping or feature-changing rules.

But how do the constraints of Chapter 4 affect the maximal strips of a phrase marker? The answer is easy to see: if the main branch of the maximal strip of A (that is, the branch consisting of all and only those nodes of P that dominate A) contains one of the types of nodes which is specified in the statement of the CNPC, the CSC, the LBC or the SSC as not permitting the chopping of one of its constituents, then the maximal strip is cut into a smaller strip at that node. That is, if the main branch contains a complex NP with a lexical head, a coordinate node, an NP on the left branch of a larger NP, or a sentence in subject position, the main branch (and the strip it is a part of) is cut at the node. The resulting substrips I call islands, and it is these islands that the feature-changing and chopping rules are constrained to operate within.

6.5. Summary

The rules of pronominalization which were discussed in § 5.3 above, and copying rules, like Left Dislocation, (6.126), or the rule which forms relative clauses with a "returning pronoun", like those in (6.154), are the rules which can cross island boundaries. But what of the deletion rules of § 6.1.3, which were shown not to be able to cross island boundaries? Under the extremely broad definition of pronominalization that was given in (5.148) of § 5.3.1, the rules of § 6.1.3 would be characterized

as pronominalizations, and would not obey the constraints on chopping and feature-changing rules which were developed in Chapters 4 and 5, but instead would be subject to the less restrictive condition which is stated in (5.152).

There is, however, one formal difference between the rules of § 5.3 and the rules in § 6.1.3: while the former rules can delete under identity in either direction, the latter rules are stated to delete only in one direction. The English rules mentioned in § 6.1.3 all deleted from the left to right (that is, the element on the right was deleted), while the Japanese rule of Relative Clause Formation deleted only from right to left. And the rule of Reflexivization, (5.98), can, in every language I know of, be formulated unidirectionally so the puzzling fact noted in footnote 24 of Chapter 5, that Reflexivization obeys the constraints on feature-changing rules, rather than the normal constraint on pronominalization, can also be accounted for. It is at present a total mystery as to why unidirectional pronominalizations should obey the constraints of Chapters 4 and 5, but it does seem to be the case in the few languages I have studied.

Summing up, then, the results of the investigation of formal properties exhibited by rules which are subject to the constraints of Chapters 4 and 5 can be expressed as in (6.244) below, where I have used the term "cross" in an undefined, but I think intuitively clear, sense:

(6.244) Variables in chopping rules, feature-changing rules, and unidirectional rules of deletion cannot cross island boundaries; variables in other rules can.

Chapter 6

FOOTNOTES

1. It has been assumed since the inception of transformational grammar (cf., e.g., Harris (1957), section 11.2) that these two rules are the same, an assumption that I find extremely dubious. The arguments that have been used are that the relative pronouns (except for that) are a subset of the wh-words used in questions, and that both rules are subject to the same constraints. But if the main argument of this chapter is correct, that all chopping transformations which move constituents over variables are subject to the same constraints, then the second argument for assuming the existence of a "WH-Rule", such as Chomsky's rule (6), which I quoted in § 2.4.0 above, can be disregarded. And the first argument for such a rule, which is essentially a morphological one, ^{is weak.} Although there are many parallels between the uses of wh-words in questions and in relative clauses, there are also puzzling differences. So while it is desirable to relate the fact that who replaces human nouns in questions, and the fact that it also does so in relatives, the fact that whose can be used for both human nouns (the boy whose body was lithe snored on) and non-human nouns (the car whose body was dented still runs) in relatives, but only for human nouns in questions (Whose body was lithe? *Whose body was dented?) causes problems

for those who assume that the two rules are the same. A more important argument against identifying these rules can be derived from the following considerations.

In sentences introduced by the expletive there, the subject NP cannot be relativized (*The two men who there were guarding the door wore shoulder holsters). It cannot be argued that sentences beginning with there are frozen to relativization, for such strings as This is a problem which there are a lot of people working on are grammatical. Nor can it be argued that there is a restriction in the English conditions box which prohibits any reordering transformation from moving the subject of a there-sentence, for such subjects can be questioned (How many men were there guarding the door?). To me, it seems most likely that the reason that such subjects behave differently under Relative Clause Formation and Question will be connected with the fact that subjects of there-sentences are always indefinite, and a restriction on the former rule that the identical NP in the constituent sentence always be definite. But whether or not this analysis proves to be correct, unless the facts just presented can be explained even on the assumption that the rules of Question and Relative Clause Formation are the same, it seems to me that the only arguments I know of which argue for this are far too weak to be regarded as having established such an identity.

2. This sentence is of course perfectly grammatical as an expression of surprise, but on such a reading, the wh-word why does not replace a purpose adverb, as it usually does in questions (witness the grammaticality of Why, he left for that reason after all!), and can be followed by a pause, unlike the word how in (6.4a) and (6.4b). These facts are indicative of the clear intuitive difference between this reading of (6.5b) and the exclamatory sentences of (6.4).

3. The six-pointed star which I have prefixed to these examples, one of McCawley's many bahnbrechenden Erfindungen (cf. McCawley (1964), fn. 2), indicates that these sentences are only grammatical if Yiddish. A particularly clear example of such a sentence, for which I am indebted to David. M. Perlmutter, is ☆ Egg creams you want, bananas you'll get.

4. In sentence (4.18) above, I showed that while elements of clauses which follow believe can be relativized, elements of clauses which follow believe the claim cannot. Since such sentences provide such a clear case of the operation of the CNPC, I will use them as a paradigm example of this constraint throughout § 6.1.

5. For some reason I cannot explain, elements cannot be extracted by the rule which makes exclamatory sentences from most extraposed clauses, although elements can be relativized here. Compare, e.g., *How brave it is certain that Tom is! with Here is a house which it is certain that Tom lived in.
6. This sentence is acceptable with the meaning "I don't see how he is so brave", if prefixed by the six-pointed star discussed in fn. 3. It cannot, however, have the intended meaning of (6.4a).
7. Personal communication.
8. Of course, since (6.15a) contains an internal sentence which is exhaustively dominated by NP, the output condition stated in (3.27) will lower its acceptability. But it should not be considered to be merely unacceptable, for the following sentence, where when modifies had been established, while awkward, is still far better than (6.15a): Bill left when that noone else was awake had been established.
9. These facts were first pointed out by Katharine Gilbert, in Gilbert (1967).

10. This fact was pointed out to me by Morris Halle.
11. A rough estimate of the perils that await the unwary grammarian who stumbles into this quagmire can be obtained from a quick perusal of the myriad confusions and inconsistencies in Ross (1964).
12. This sentence cannot be blocked by any ordering of the rules of NP Shift and Conjunction Reduction if the analysis presented in Peters (in preparation) is correct. Peters argues that on the reading of (6.57a) where the meaning is that the playing of the guitar and the singing are simultaneous, the conjoined VP node should derive from a conjoined node in deep structure.
13. If both versions of (6.76b) are felt to be ungrammatical, this rule must have the general constraint imposed upon it that no element of a clause containing a finite verb can be preposed.
14. These facts were brought to my attention by Maurice Gross.
15. That is, the morpheme en 'of it' must command the verb to which it is to be prefixed as a clitic. For a detailed treatment of the grammar of clitics in several Romance languages, cf. Perlmutter (in preparation).

16. In fact, if la maison is pronominalized fully, not merely to some form such as celle-là 'that one there', nothing can save (6.81a) from ungrammaticality. The CSC will not allow the clitic to be moved, but the rule which moves clitics to preverbal position will not let it stay where it is. In such an impasse, no matter which rule wins out, an ungrammatical sentence will result.

17. As a rough indicator of the superficiality with which I have discussed this construction (indeed, all the constructions in § 6.1), consider the following facts, which were pointed out to me by Sylvain Bromberger. In the sentence below,

Je vois les fenêtr[^]es de la maison et la porte du garage.

'I see the windows of the house and the door of the garage.'

while it is not possible to pronominalize and convert into en either of the underlined phrases in isolation, if both are pronominalized, a grammatical sentence results:

J'en vois les fenêtr[^]es et la porte.

I of it see the windows and the door.

'I see the windows and the door { of it }
{ thereof }.'

What is particularly interesting is that the en here seems to refer neither to de la maison 'of the house', nor to du garage 'of the garage', but rather to the set, or gestalt, or individual (to use Nelson Goodman's term) consisting of them both, a concept only roughly translatable into English by such locutions

as the house-garage. Notice that the reason that the CSC can be "violated" here is, in a strange new way, the same reason that across-the-board rules (cf. § 4.2.4.2) can "violate" it. I cannot deal further with this extremely interesting problem here.

18. The grammar of comparatives in general, and of these by-phrases in particular, has been intensively examined by Austin Hale. Cf. Hale (1965), Hale (to appear).
19. This term is due to Maurice Gross.
20. The ungrammatical versions of the sentences of (6.150), where the pronouns are in the nominative case, can be blocked by imposing the condition on Left Dislocation that the dislocated NP be marked with the feature [+ objective]. This feature will only produce a phonetic difference if the NP to which it is attached is one of the pronouns i, he, she, we, they.
21. Personal communication. Classical Arabic grammarians refer to pronouns like the boxed ones in (6.154) as "returning pronouns."

22. That the rule which converts (6.162b) to (6.162c) changes be to have should occasion no surprise. There are a number of deep ways in which these two verbs behave the same under transformational rules, but a discussion of these facts would be out of place here. One interesting rule of Italian, which changes have to be in certain circumstances, will be discussed in Perlmutter (op. cit.)
23. That this sentence may be acceptable to some, with the meaning "Jack will cause a hole to appear in my pocket", need not concern us here.
24. This sentence is grammatical if Joe appears in the relative clause, but I am not sure it is an instance of the same construction.
25. I am not sure that the contrast in acceptability between (6.172c) and (6.174c) is great.
26. I have greatly oversimplified the statement of this rule. Lakoff and Peters (op. cit.) argue, e.g., that the and in term 2 of (6.176) should have been converted into some preposition (cf. He left with her, She is similar to him, I am different from her) before this rule applies. Also it is an open

question as to whether term 2 should be Chomsky-adjoined or daughter-adjoined to term 3.

27. There are some speakers who appear to find no difference in acceptability between the sentences in (6.187), but I know of no one for whom sentences like (3.20b), (3.35b), and (3.36b) are grammatical. I cannot explain this asymmetry.
28. Of course, (6.220b) is not ungrammatical on all readings. It can mean 'That your spouse won't be a student is certain', but this meaning is not related to the structure underlying (6.220a).
29. Klima postulates a negative constituent, neg, so his rule of Negative Incorporation is not a feature-changing rule but rather a chopping rule which inserts the chopped neg into some other part of a phrase marker. But I know of no valid argument for treating negation as being anything but a feature; Klima's main argument that negation is a constituent has to do with his notion in construction with, which I have already argued (cf. § 5.2.2 above) is not adequate to the task of accounting for the facts of Indefinite Incorporation, to say nothing of restrictions on the other members of the class of feature-changing rules. Even if Klima's analysis is right, however, so that Negative Incorporation has to be considered to be a rule

which chops and inserts, it would still be possible to account for the difference between (6.219b) and (6.220b) by broadening the hypothesis stated in (6.193) so that it covered all kinds of chopping rules.

Note also that the contrast between (6.220b) and (6.217b) provides an additional argument for pruning. Thus if the NP the writers of some of the reports is sententially derived, which I believe is inescapable, then by the time the rule of Negative Incorporation applies, the sentence must have been pruned, for otherwise the SSC will not allow (6.217a) to be converted into (6.217b).

30. I have no explanation at present for the differential behavior of the sentences in (6.224), (6.225) and (6.226), if the determiner of picture is this.
31. In Ross (1967c), I show how this rule provides evidence that all declarative sentences are embedded as the direct object of a verb like say, whose subject is I, in deep structure. Note, by the way, that this rule is unlike the normal rule of Reflexivization in that it can go down into clauses.
32. For a definition of the term 'proper analysis', cf. Chomsky (1955), Fraser (1963).

Chapter 7

CONCLUSION

This thesis has been an attempt to provide the theory of grammar with a more adequate notion of syntactic variable, a notion which I showed in Chapter 1 and elsewhere to be absolutely essential if the central fact of syntax -- that there are unbounded syntactic processes -- is to be captured. In Chapter 2, I argued that the earliest attempt at limiting the power of variables, Chomsky's A-over-A principle, is both too strong and too weak. A far more serious inadequacy in this principle than those I discussed in Chapter 2 is the fact that it cannot be extended in any natural way, as far as I can see, to account for the phenomena which led me to construct a theory of syntactic islands. In Chapter 3, I gave a preliminary sketch of a theory of node deletion, or pruning -- a theory which interacts closely with the constraints developed in later chapters. In this chapter, I also gave some evidence that a rather substantial revision in the syntactic component was necessary -- that many conditions previously thought to be best stated as restrictions on particular rules should instead be regarded as static output conditions, with the rules in question being freed of all restrictions. These output conditions effect no changes on final derived constituent structures -- rather they lower the acceptability of sentences output by the transformational component, if these sentences exhibit certain formal properties which are specified in

the conditions. Thus the relationship between grammaticality and acceptability must become much more abstract than has been assumed.

In Chapter 4, I formulated two putatively universal constraints and one putatively universal convention, as well as a number of language-particular constraints, which I showed to be intermediate in generality between conditions on particular rules and universal constraints, and thus to necessitate a further addition to the syntactic component -- the conditions box.

In Chapter 5, I showed that various facts made necessary the adoption of a new mechanism into the theory of grammar, so that rules whose variables would otherwise be too strong could be correctly stated. Langacker's notion of command, with suitable extensions, was demonstrated to be adequate to this task, and a number of interesting restrictions on types of rules were shown to be stateable in terms of this notion. Various rules of pronominalization were discussed, and it was shown that while these rules did not obey the constraints of Chapter 4, they also did not obey restrictions which could be stated in terms of command.

And in Chapter 6, I discussed a large number of rules, showing them all to be subject to the constraints developed in Chapters 4 and 5. A close examination of all rules subject to these constraints reveals that not only are feature-changing rules and unidirectional deletion rules subject to the same constraints as the chopping rules for which the constraints were first developed, but that it is only rules which

make crucial use of variables which are subject to them. Thus, in a sense, it is wrong to speak of constraints on rules -- the constraints in Chapters 4 and 5 are rather to be construed as limiting the power of variables that can appear in a certain type of rules. In conjunction with the notion command, the constraints divide up phrase markers into islands, the maximal domains of rules of the type in question.

All the proposals I have made should be regarded as being extremely tentative, for our present knowledge of syntax is ridiculously small. This thesis has raised far more questions than it has attempted to answer. Among them are: Why should rules which adjoin terms to the right side of a variable be upward bounded, and not those which adjoin terms to the left of a variable? Why should it be that chopping rules, feature-changing rules and unidirectional deletion rules share the property of being subject to the constraints, to the exclusion of other rules? Why should there be a difference between unidirectional and bidirectional pronominalization? Why should it be that the constraints are all "downward-oriented"-- that is, why should it be that there are phrase marker configurations that prevent elements indefinitely far below them from undergoing various syntactic operations, whereas there are no configurations which affect elements indefinitely far above them? Why should complex NP's, coordinate nodes, sentential subject clauses,

and NP's on the left branches of larger NP's all function the same in defining islands? Can islands be shown to behave like psycholinguistic entities?

While none of these questions can now be answered, the fact that they can now be asked is a major result of the thesis. For as e.e. cummings has said, "always the more beautiful answer who asks the more beautiful question."

BIBLIOGRAPHY

- Anderson, Stephen R. (1967). "How do so does so." Unpublished paper, M.I.T.
- Bach, Emmon (1967). "Problominalization." Unpublished mimeograph, University of Texas, Austin, Texas.
- Bierwisch, Manfred (1966). "Regeln fur die Intonation deutscher Sätze." Studia Grammatica, VII, pp. 99-201. Akademie Verlag, East Berlin.
- Blass, Birgit (1965). A Comparison of the Adverbs and Prepositions of Danish and English. Master's thesis, Columbia University.
- Bolinger, Dwight (1967). "The Imperative in English." To appear in Festschrift for Roman Jakobson. The Hague: Mouton & Co.
- Browne, E. Wayles, III.(1966). "On the problem of enclitic placement in Serbo-Croatian." Unpublished paper, M.I.T.
- Chomsky, Noam (1955). The Logical Structure of Linguistic Theory. Mimeographed, M.I.T. Library, Cambridge, Mass.
- Chomsky, Noam (1957). Syntactic Structures. The Hague: Mouton & Co.
- Chomsky, Noam (1961). "On the notion 'rule of grammar'." In R. Jakobson (ed.), Structure of Language and Its Mathematical Aspects, Proceedings of the Twelfth Symposium in Applied Mathematics, Vol. 12, pp. 6-24. Providence, R.I.: American Mathematical Society.
- Chomsky, Noam (1962). "A transformational approach to syntax." In - A.A. Hill (ed.), Proceedings of the 1958 Conference on Problems of Linguistic Analysis in English, pp. 124-148. Austin, Texas. Reprinted in Fodor and Katz (1964).
- Chomsky, Noam (1964a). "The logical basis of linguistic theory." In H. Lunt (ed.), Proceedings of the Ninth International Congress of Linguists, Cambridge, Mass., 1962. The Hague: Mouton & Co.
- Chomsky, Noam (1964b). Current Issues in Linguistic Theory. The Hague: Mouton & Co.

- Chomsky, Noam (1965). Aspects of the Theory of Syntax. M.I.T. Press, Cambridge, Mass.
- Dean, Janet (1967). "Noun phrase complementation in English and German." Unpublished paper, M.I.T.
- Fillmore, Charles J. (1965a). "On the notion of 'equivalent sentence structure'." Project on Linguistic Analysis, Report No. 11. Ohio State University, Columbus, Ohio.
- Fillmore, Charles J. (1965b). Indirect Object Constructions in English and the Ordering of Transformations. The Hague: Mouton & Co.
- Fodor, Jerry A., and Jerrold J. Katz (1964). The Structure of Language: Readings in the Philosophy of Language. Englewood Cliffs, N.J.: Prentice-Hall.
- Fraser, J. Bruce (1963). "The linguistic framework for a sentence recognition and analysis routine: Transformation structure." Working Paper W-6266. Bedford, Mass.: Mitre Corporation.
- Fraser, J. Bruce (1965). An Examination of the Verb-Particle Construction in English. Unpublished Ph.D. thesis, M.I.T.
- Gilbert, Katharine F. (1967). "Which-sentential relatives and as-clauses." Unpublished paper, M.I.T.
- Hale, Austin (1965). "Quantification and the English comparative." Unpublished mimeograph, University of Illinois.
- Hale, Austin (to appear). Quantification and the English Comparative. The Hague: Mouton & Co.
- Halle, Morris, and Noam Chomsky (to appear). The Sound Pattern of English. New York: Harper & Row.
- Harris, Zellig S. (1957). "Co-occurrence and transformation in linguistic structure." Language, 33, pp. 293-340. Reprinted in Fodor and Katz (1964).
- Jackendoff, Ray (1966a). "Pronominalization, reflexivization and the semantic component." Unpublished paper, M.I.T.
- Jackendoff, Ray (1966b). "The erased NP in relative clauses and complements." Unpublished paper, M.I.T.
- Katz, Jerrold J., and Paul M. Postal (1964). An Integrated Theory of Linguistic Descriptions. Cambridge, Mass.: M.I.T. Press.
- Keyser, S. Jay (1964). "Review of Jacobson, Adverbial Positions in English. To appear in Language."

- Kiefer, Ferenc (1966). "On emphasis and word order in Hungarian." Unpublished paper, M.I.T.
- Klima, Edward S. (1964). "Negation in English." In Fodor and Katz (1964).
- Kuroda, Sige-Yuki (1964). "A note on English relativization." Unpublished paper, M.I.T.
- Kuroda, Sige-Yuki (1965). Generative Grammatical Studies in the Japanese Language. Unpublished Ph.D. thesis, M.I.T.
- Lakoff, George (1965). On the Nature of Syntactic Irregularity. Mathematical Linguistics and Automatic Translation, Report No. NSF-16 to The National Science Foundation, Harvard University, Computation Laboratory.
- Lakoff, George (1966). "Deep and surface grammar." Unpublished paper, Harvard University.
- Lakoff, George (1965). "Pronominalization and the analysis of adverbs." To appear in Rosenbaum, Peter S., and Roderick Jacobs (ed.), Readings in English Transformational Grammar.
- Lakoff, George, and P. Stanley Peters (1966). "Phrasal conjunction and symmetric predicates." Mathematical Linguistics and Automatic Translation, Report No. NSF-17 to The National Science Foundation, Harvard University, Computation Laboratory.
- Lakoff, George, and John Robert Ross (1966). "A criterion for verb phrase constituency." Mathematical Linguistics and Automatic Translation, Report No. NSF-17 to The National Science Foundation, Harvard University, Computation Laboratory.
- Lakoff, George, and John Robert Ross (in preparation a). The Abstractness of Underlying Structures.
- Lakoff, George and John Robert Ross (in preparation b). The Transformational Component.
- Langacker, Ronald W. (1966). "On pronominalization and the chain of command." Unpublished multilith, University of California at San Diego, La Jolla. (Page references are to this version.) To appear in Schane, Sanford A., and David A. Reibel (ed.), Modern Studies in English. Englewood Cliffs, N.J.: Prentice-Hall.

- Lees, Robert B. (1960). The Grammar of English Nominalizations. The Hague: Mouton & Co.
- Lees, Robert B. (1961). "Grammatical analysis of the English comparative construction." Word, 17, pp. 171-185.
- Lees, Robert B., and Edward S. Klima (1963). "Rules for English pronominalization." Language, 39, pp. 17-28.
- McCawley, James D. (1964). "Quantitative and qualitative comparison in English." Paper presented at the Winter Meeting of the Linguistic Society of America, December 29, 1964.
- Perlmutter, David M. (in preparation). Deep and Surface Structure Constraints in Grammar. Ph.D. thesis, M.I.T.
- Peters, P. Stanley (in preparation). Coordinate Conjunction in English. Ph.D. thesis, M.I.T.
- Postal, Paul M. (1964). "Underlying and superficial linguistic structure." Harvard Educational Review, 34, pp. 246-266.
- Postal, Paul M. (1966a). "On so-called 'pronouns' in English." In Dineen, F.P., S.J. (ed.), Report of the Seventeenth Annual Roundtable Meeting on Linguistics and Language Studies. Washington, D.C.: Georgetown University Press, pp. 177-206.
- Postal, Paul M. (1966b). "A note on 'understood transitively'." International Journal of American Linguistics, 32.1 (1966).
- Qualls, Brandon (to appear). Ph.D. thesis, M.I.T.
- Quine, Willard V. (1960). Word and Object. Cambridge, Mass.: M.I.T. Press, and New York: Wiley.
- Rosenbaum, Peter S. (1965). The Grammar of English Predicate Complement Constructions. Unpublished Ph.D. thesis, M.I.T.
- Ross, John Robert (1964). A Partial Grammar of English Superlatives. Master's thesis, University of Pennsylvania, Philadelphia.
- Ross, John Robert (1966a). "Relativization in Extraposed Clauses (A Problem which Evidence is Presented that Help is Needed to Solve)." Mathematical Linguistics and Automatic Translation, Report No. NSF-17 to The National Science Foundation, Harvard University, Computation Laboratory.
- Ross, John Robert (1966b). "On the nature of bounding in syntactic rules." Unpublished paper, M.I.T.

- Ross, John Robert (1966c). "Adjectives as noun phrases." Unpublished ditto, M.I.T.
- Ross, John Robert (1966d). "A proposed rule of tree-pruning." Mathematical Linguistics and Automatic Translation, Report No. NSF-17 to The National Science Foundation, Harvard University, Computation Laboratory.
- Ross, John Robert (1967a). "On the cyclic nature of English pronominalization." To appear in Festschrift for Roman Jakobson. The Hague: Mouton & Co.
- Ross, John Robert (1967b). "Auxiliaries as main verbs." Unpublished mimeograph, M.I.T.
- Ross, John Robert (1967c). "On declarative sentences." To appear in Jacobs, Roderick and Peter S. Rosenbaum (ed.), Readings in English Transformational Grammar.
- Ross, John Robert (1967d). "Gapping and the order of constituents." To appear in the Proceedings of the Tenth International Congress of Linguists.
- Smith, C. (1961). "A class of complex modifiers in English." Language 37, pp. 342-365.
- Vendler, Z. (1962). "The order of adjectives." Transformations and Discourse Analysis Project paper no. 31, University of Pennsylvania.
- Warshawsky, F. (1965a). "Reflexivization." Unpublished paper, M.I.T.
- Warshawsky, F. (1965b). "Reflexivization." Unpublished paper, M.I.T.
- Winter, W. (1965). "Transforms without kernels?" Language, 41.3, pp. 484-489.
- Zwicky, A.M., Jr., and S. Isard (1963). "Some aspects of tree theory." Working Paper W-6674. Bedford, Mass.: Mitre Corporation.

BIOGRAPHY

I was born on May 7, 1938, in Boston, Massachusetts, the son of Dr. Douglas Allen Ross and Eleanor Campbell Mott Ross. I lived in Montreal and then in Sudbury, Massachusetts, until I was nine, when we moved to Poughkeepsie, New York. I had the good fortune to go to the Poughkeepsie Day School from the third grade to the eighth grade, graduating in 1952. My luck continuing, I was accepted at, and managed, despite many disciplinary problems, to stay in, Phillips Academy, Andover, Massachusetts, where I graduated in 1956.

As I entered Yale in the fall of that year, intending to major in mathematics, I stumbled by chance into a brilliant and fascinating introductory course in linguistics -- which I had never heard of -- a course taught by the late Bernard Bloch. After I had failed out of mathematics, he allowed me to piece together a special undergraduate major in linguistics, and became my adviser. It is to his understanding, humor, and patience that I owe the fact that I am now a linguist.

After graduating from Yale in 1960, I received a grant from the Deutscher Akademische Austauschdienst and went for two semesters, to the University of Bonn and for one semester to Berlin, to the Free University and to the Technical University, where I studied a little linguistics and a lot of everything else.

Having returned to the United States, I received a Woodrow Wilson Fellowship to study at the University of Pennsylvania,

where Zellig Harris put me forever profoundly in his debt by introducing me to the fascinatingly complex realm of syntax. Under his tutelage, I wrote a Master's Thesis entitled "A Partial Grammar of English Superlatives", receiving the degree in May 1964.

Since January 1964, I have been a student at the Massachusetts Institute of Technology, where I have had the privilege of studying with Noam Chomsky, Morris Halle, Roman Jakobson, Paul Kiparsky, Edward Klima, G. Hubert Matthews, and Paul Postal.