

Recent String-Inspired Advances in Yang-Mills Perturbation Theory

Marcus Spradlin

University of Michigan

&

Institute for Advanced Study, Princeton

Outline

This talk will be about **gluon scattering amplitudes** in QCD and supersymmetric gauge theories. These are notoriously difficult to compute, even at tree-level, so this is fertile ground for new insights and methods. Even esoteric ideas from string theory are welcome in this game, as long as they work!

Part 1: A review of some of the exciting progress at **tree-level** and **one-loop** which has followed Witten's discovery of rich mathematical structure hidden in these amplitudes [[Witten \(12/03\)](#)].

Part 2: New techniques for exploring the structure of multiloop amplitudes [[Cachazo, M.S., Volovich \(01/06, 02/06, and to appear\)](#)].

Broad Goals of this Research Program

Explore the hidden mathematical structure in perturbative gauge theory, and

Exploit that structure to help make previously impossible calculations possible (in some cases, not just possible but trivial).

Generally, we begin with **supersymmetric** gauge theories, where the structure is simplest and new ideas are easiest to explore. Most of the techniques I will describe can be applied, with some effort, to other theories, including honest QCD.

At tree-level there is no distinction: **tree-level gluon amplitudes in QCD are secretly supersymmetric**. One-loop QCD amplitudes can be naturally split into a supersymmetric part and a non-supersymmetric part.

Tree Level

Why, in the 21st century, do we still find it useful to study tree amplitudes?

- Even just two years ago, few useful closed form expressions were known.
- **Compact explicit formulas** are better than numerical algorithms or recursion relations for currents.
- Tree-level amplitudes form the basic building blocks of loop amplitudes through **unitarity**,

$$\text{Im } A^{1\text{-loop}} \sim \sum \int A^{\text{tree}} A^{\text{tree}}.$$

- A better understanding of the **mathematical structure** of tree-level amplitudes will guide us as we attack more complicated loop amplitudes.

Twistor String Theory

Many recent advances have been made following Witten's conjecture that Yang-Mills theory (at least at tree-level) admits a description in terms of a **twistor string theory**. The best evidence in favor of the existence of twistor string theory is a mysterious formula, derived from string theory, which recasts the problem of calculating *any* tree-level n -gluon scattering amplitude into the problem of solving some polynomial equations. [Roiban, M.S., Volovich (03/04)].

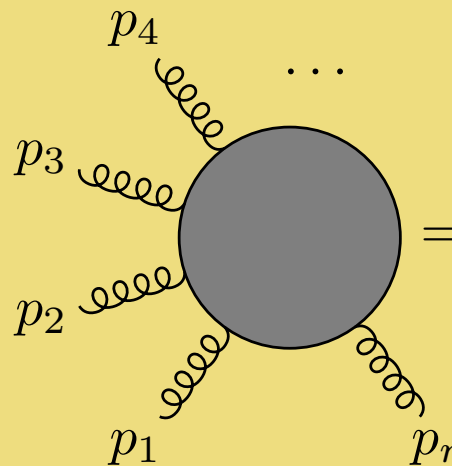

A Feynman diagram representing a tree-level n -gluon scattering amplitude. It consists of a central grey circle with n external wavy lines (gluons) attached. The lines are labeled with momenta $p_1, p_2, p_3, p_4, \dots, p_n$ in a clockwise direction starting from the bottom. The diagram is equated to a mathematical expression.

$$= i(2\pi)^4 \delta^4\left(\sum p_i\right) \sum_{x_j: f_i(x_j, p) = 0} \frac{1}{\det(\partial f_i / \partial x_j)}$$

In twistor string theory, amplitudes are calculated by an integral over certain instantons, which are identified with curves in supersymmetric twistor space.

These curves can be connected or disconnected,



Our calculation was based on the former, but the latter were used to derive a more computationally useful formula [Cachazo, Svřcek, Witten (03/05)].

$$\begin{array}{c}
 \begin{array}{c}
 \text{---} \\
 \diagup \quad \diagdown \\
 + \quad \quad + \\
 | \\
 + \text{---} \bullet \text{---} \text{---} \\
 | \\
 - \quad \quad + \\
 \diagdown \quad \diagup \\
 \text{---}
 \end{array}
 \quad = \quad
 \begin{array}{c}
 \text{---} \\
 | \\
 + \text{---} \text{---} \\
 | \\
 +
 \end{array}
 \quad - \quad
 \begin{array}{c}
 + \\
 | \\
 + \text{---} \text{---} \\
 | \\
 - \\
 + \\
 | \\
 - \text{---} \text{---} \\
 | \\
 -
 \end{array}
 \quad + \text{ other decompositions}
 \end{array}$$

Fantastic, but not yet the end of the story...

Consider the six-particle amplitude $A(1^+, 2^+, 3^+, 4^-, 5^-, 6^-)$. Instead of summing 220 Feynman diagrams [Berends & Giele (1987)], [Mangano, Parke, Xu (1988)], we can write down the answer with just 6 CSW diagrams:

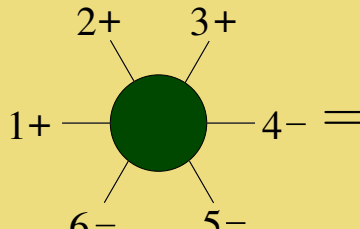

$$= \frac{[1\ 2]^3}{[2\ \eta][\eta\ 6][6\ 1]} \frac{1}{(p_3 + p_4 + p_5)^2} \frac{[\eta\ 3]^3}{[3\ 4][4\ 5][5\ \eta]} + 5 \text{ similar terms,}$$

but a slightly more compact formula is

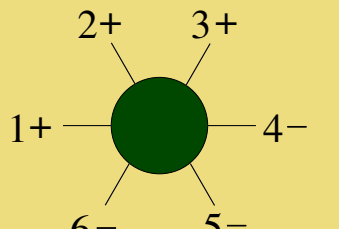

$$= \frac{\langle 1|2 + 3|4\rangle^3}{(p_2 + p_3 + p_4)^2 [2\ 3][3\ 4]\langle 5\ 6\rangle\langle 6\ 1\rangle[2|3 + 4|5\rangle}$$

$$+ \frac{[6|1 + 2|3\rangle^3}{(p_6 + p_1 + p_2)^2 [2\ 1][1\ 6]\langle 5\ 4\rangle\langle 4\ 3\rangle[2|1 + 6|5\rangle}.$$

The eight-particle amplitude $A(1^-, 2^-, 3^-, 4^-, 5^+, 6^+, 7^+, 8^+)$ would require 34,300 Feynman diagrams (probably never seriously attempted), or 44 CSW diagrams:

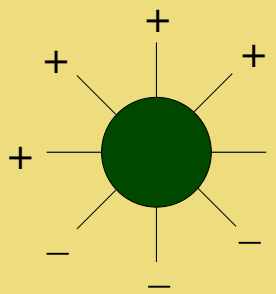

$$= \frac{[\eta 8]^3}{[8 1][1 2][2 3][3 \eta]} \frac{1}{(p_8 + p_1 + p_2 + p_3)^2} \frac{\langle \eta 4 \rangle^3}{\langle 4 5 \rangle \langle 5 6 \rangle \langle 6 7 \rangle \langle 7 \eta \rangle}$$

+ 43 similar terms

Again in this case there is a simpler formula (originally discovered “accidentally” [Roiban, M.S., Volovich (12/04)])

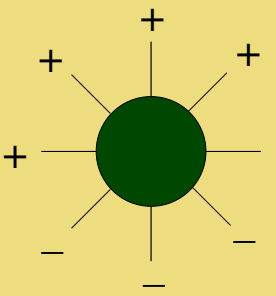

$$= \frac{[5|4 + 3 + 2|1\rangle^3}{(p_2 + p_3 + p_4 + p_5)^2 [2 3][3 4][4 5] \langle 6 7 \rangle \langle 7 8 \rangle \langle 8 1 \rangle [2|3 + 4 + 5|6\rangle}$$

+ 5 similar terms

On-Shell Recursion

Where did these simple formulas come from? They were an unexpected byproduct of one-loop amplitudes, whose infrared singularities are known on general grounds to be proportional to tree amplitudes.

The general structure of these infrared singularities indicated that tree amplitudes should satisfy a **quadratic on-shell** recursion relation.

Indeed, a precise recursion relation of the form

$$A_n = \sum_{r=2}^{n-2} A_{r+1} \frac{1}{p_r^2} A_{n+1-r} \quad (1)$$

was formulated and directly proven in [\[Britto, Cachazo, Feng \(12/04\) & with Witten \(01/05\)\]](#).

Zigzag Diagrams

On-shell recursion relations are great, but explicit solutions are even better. The BCFW recursion relation admits a closed form solution for ‘split helicity’ amplitudes [Britto, Feng, Roiban, M.S., Volovich (03/05)].

The amplitude $A(1^-, \dots, p^-, (q+1)^+, \dots, n^+)$ is given by a sum over all ‘zigzag diagrams’, of an expression which is trivial to write down

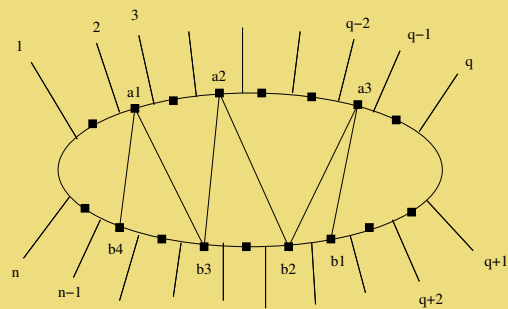

$$= \frac{\langle q | P_{q,b_1} P_{b_1+1,a_1} P_{a_1+1,b_2} \cdots P_{b_4+1,1} | 1 \rangle^3}{P_{q,b_1}^2 P_{b_1+1,a_1}^2 P_{a_1+1,b_2}^2 \cdots P_{b_4+1,1}^2 [q-1 | P_{q,b_1} | b_1 \rangle \langle b_1+1 | P_{b_1+1,a_1} | a_1 \rangle]} \times \frac{\langle b_1 b_1+1 \rangle \cdots \langle b_4 b_4+1 \rangle [a_1 a_1+1] \cdots [a_3 a_3+1]}{\langle q q+1 \rangle \cdots \langle n 1 \rangle [2 3] \cdots [q-2 q-1]}$$

Zigzag diagrams are gauge invariant and a single zigzag diagram can encapsulate thousands or billions of individual Feynman diagrams.

Tree Level—Solved

As promised, the tree-level techniques have been widely applied:

CSW rules:

- for gluons with fermions and scalars [Georgiou, Khoze 04/04], [Wu, Zhu 06/04],
- for amplitudes with quarks [Georgiou, Glover, Khoze 07/04], [Su, Wu 07/04],
- for Higgs plus partons [Dixon, Glover, Khoze 11/04], [Badger, Glover, Khoze 12/04],
- and for electroweak vector boson currents [Bern, Forde, Kosower, Mastrolia 12/04].

On-shell recursion relations:

- for amplitudes with gluons and fermions [Luo, Wen 01/05, 02/05],
- and for massive particles [Badger, Glover, Khoze, Svřcek 04/05],
- and for graviton amplitudes [Bedford, Brandhuber, Spence, Travaglini 02/05], [Cachazo, Svřcek 02/05].

One Loop

One-loop gluon amplitudes admit the decomposition

$$\mathcal{A}^{\text{QCD}} = \mathcal{A}^{\mathcal{N}=4} - 4\mathcal{A}_{\text{chiral}}^{\mathcal{N}=1} + \mathcal{A}^{\text{scalar}}.$$

I will discuss only the first term, $\mathcal{A}^{\mathcal{N}=4}$, and provide references for the impressive progress that has been made on the other two terms.

Organizing Principle: Integral Basis

In the $\mathcal{N} = 4$ theory, all integrals which appear in any Feynman diagram calculation can be reduced to a set of scalar box integrals using Passarino-Veltman reduction. (In $\mathcal{N} = 1$, triangles also appear.)

In other words, scalar box integrals provide a **complete basis** for all one-loop gluon amplitudes in $\mathcal{N} = 4$.

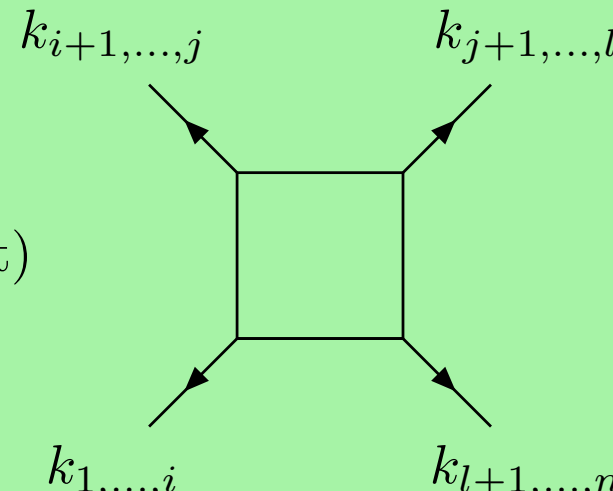
$$\mathcal{A}^{1\text{-loop}} = \sum_{\text{boxes}} (\text{coefficient})$$

The problem is to calculate all of the coefficients for a desired amplitude.

Generalized Unitarity

Any supersymmetric one-loop amplitude is completely determined by its branch cuts and discontinuities [Bern, Dixon, Dunbar, Kosower (1994)]. Therefore, it is natural to use unitarity cuts to compute these coefficients \implies 'unitarity based method' [Bern, Dixon, Kosower (1997,2000,2004)].

Each scalar box integral has a unique leading singularity, and it looks like the discontinuity of any desired amplitude across this singularity should be given by a quadruple cut. However, there are two problems which used to hinder the full utility of generalized unitarity.

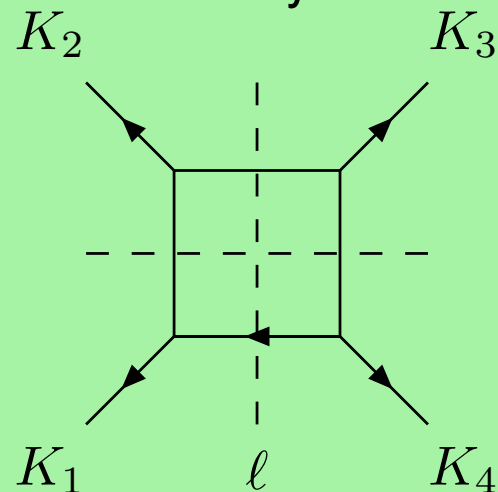

The Importance of Twistor Space

The first problem is that it would appear that there is no such thing as a quadruple cut, because the integral should localize onto those ℓ satisfying

$$\{\ell : \ell^2 = 0, (\ell - K_1)^2 = 0, (\ell - K_1 - K_2)^2 = 0, (\ell - K_1 - K_2 - K_3)^2 = 0\}$$

but in Minkowski signature there are no solutions!

A related problem is that the three-gluon amplitude vanishes on-shell, so the quadruple cut (even if it existed) would provide no information if any corner of the box has only a single external leg.

Both of these problems are solved if we work in signature $(--++)$ instead of Minkowski space ([\[Britto, Cachazo, Feng \(12/04\)\]](#) and [\[Witten \(12/03\)\]](#) respectively).

The lesson is that amplitudes in split signature (natural in twistor space) have a richer structure of singularities, allowing all coefficients to be computed in terms of tree-level amplitude via quadruple cuts.

One-Loop— Supersymmetric Case Solved

These techniques have also been used to solve $\mathcal{N} = 1$ amplitudes:

- All $\mathcal{N} = 1$ MHV amplitudes from MHV diagrams. [Quigley, Rozali; Bedford, Brandhuber, Spence, Travaglini (10/04)].
- All $\mathcal{N} = 1$ NMHV amplitudes from quadruple cuts [Bidder, Bjerrum-Bohr, Dunbar, Perkins (02/05)]
- A new basis of boxes and triangles allowing for all $\mathcal{N} = 1$ amplitudes to be computed from generalized unitarity [Britto, Buchbinder, Cachazo, Feng (03/05)]

and progress has been made on $\mathcal{A}^{\text{scalar}}$, the last piece needed for real QCD:

- Non-rational piece of scalar “MHV” amplitudes [Bedford, Brandhuber, Spence, Travaglini (12/04)].
- Recursion relations for rational pieces [Bern, Dixon, Kosower (01/05) and (05/05)].
- Clean separation of rational and non-rational pieces, leading to the full MHV 6-gluon one-loop amplitude in honest QCD. [Bern, Dixon, Kosower (07/05)].

What Was Known Pre-Twistors

One-loop amplitudes of gluons: $A^{\text{QCD}} = A^{\mathcal{N}=4} - 4A^{\mathcal{N}=1}_{\text{chiral}} + A^{\text{scalar}}$

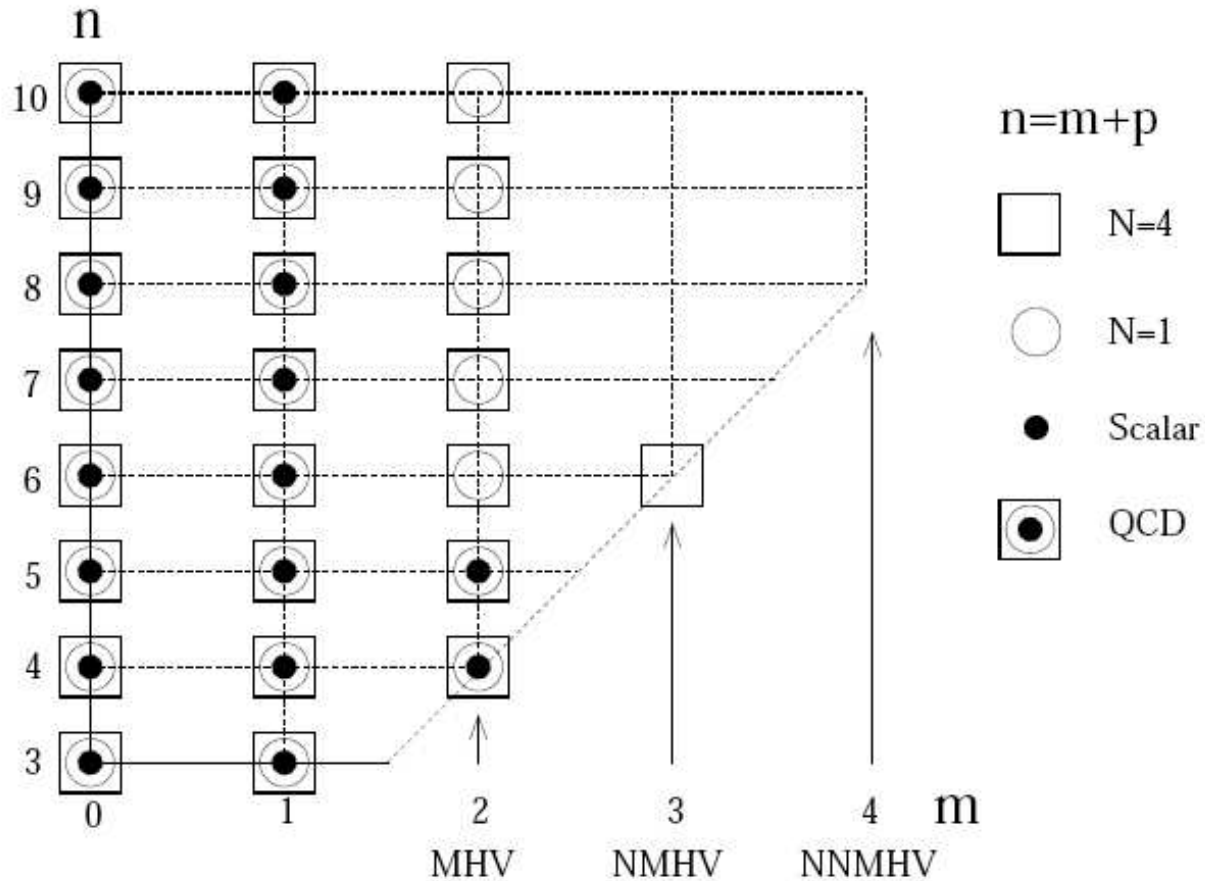

Adapted from [Dixon, TASI 1995].

Where We Are Now

$$A^{\text{QCD}} = A^{\mathcal{N}=4} - 4A^{\mathcal{N}=1}_{\text{chiral}} + A^{\text{scalar}}$$

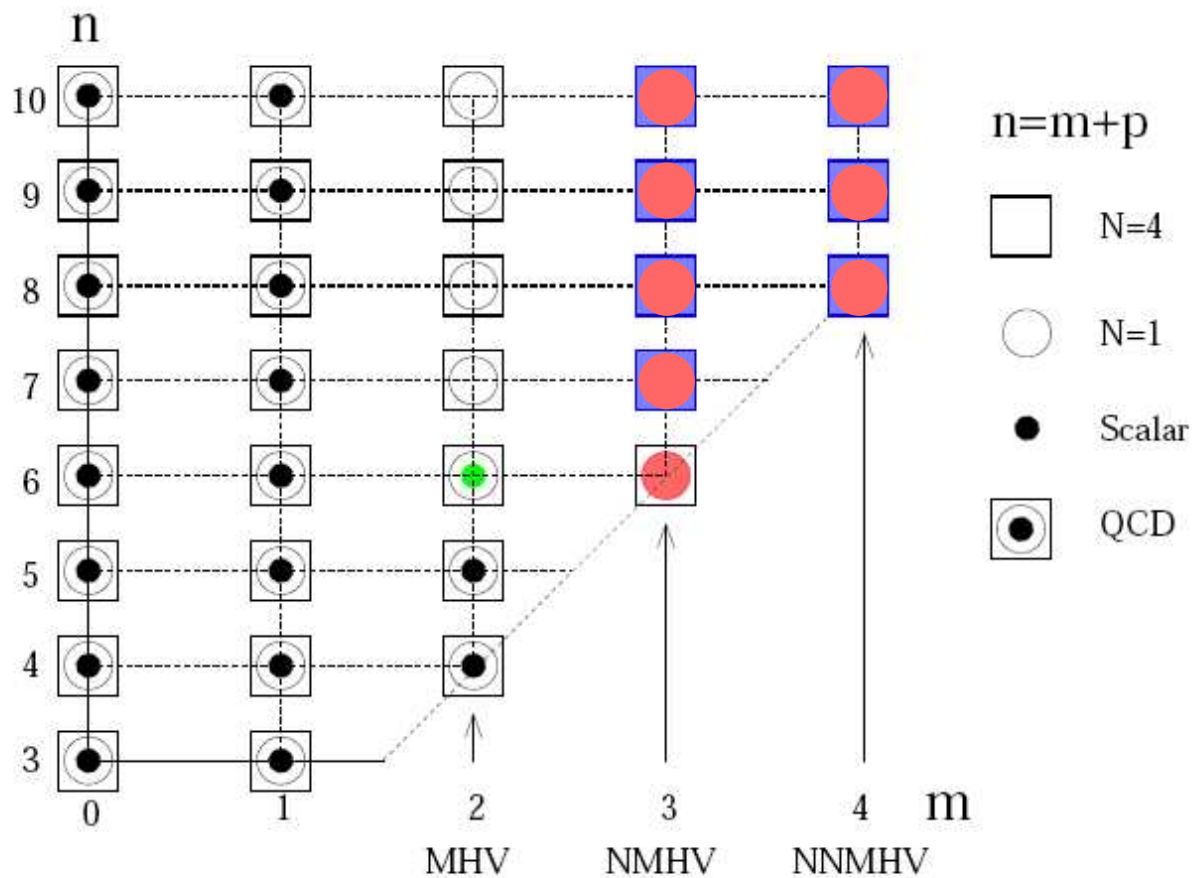

Adapted from [Cachazo, Strings 2005].

Two Loops and Beyond

I will now restrict my attention to **maximally supersymmetric** $\mathcal{N} = 4$ Yang-Mills theory—already here very little is explicitly known.

However, **AdS/CFT** suggests that the planar limit (gauge group $SU(N)$ with $N \rightarrow \infty$) of $\mathcal{N} = 4$ Yang-Mills theory should be remarkably simple, possibly even **integrable**.

It is an interesting question whether we can see any sign of this simplicity in the perturbative expansion of the theory—for example, perhaps we can sum it explicitly?

An intriguing idea in this direction is that loop amplitudes satisfy **iteration relations**. For example, at two loops it has been shown that...

$$\begin{aligned}
& \frac{1}{4} s^2 t \left(\text{Diagram 1} \right) + \frac{1}{4} t^2 s \left(\text{Diagram 2} \right) \\
& = \frac{1}{8} s^2 t^2 \left(\text{Diagram 3} \right)^2 - \frac{1}{2} st f(\epsilon) \left(\text{Diagram 4} \right) - \frac{\pi^4}{72} + \mathcal{O}(\epsilon)
\end{aligned}$$

$$f(\epsilon) = (\psi(1 - \epsilon) - \psi(1))/\epsilon \quad [\text{Anastasiou, Bern, Dixon, Kosower (2003)}]$$

This identity is purely a property of Feynman loop integrals in scalar ϕ^3 theory—a property which happens to have a nice application to Yang-Mills theory!

Iterative Structures

It has been conjectured that similar iterative relations hold to all loops,

$$M^{(L)}(\epsilon) = P^{(L)}(M^{(1)}(\epsilon), \dots, M^{(L-1)}(\epsilon)) + f^{(L)}(\epsilon)M^{(1)}(L\epsilon) + C^{(L)} + \mathcal{O}(\epsilon)$$

but they have only been explicitly verified for the $L = 2$ and $L = 3$ [Bern, Dixon, Smirnov (2005)] four-particle amplitudes.

This conjecture doesn't come completely out of the blue—it is based upon similar iterative structures which have been shown to hold for the infrared and collinear singularities of multiloop amplitudes [Catani (1998)], [Sterman, Tejeda-Yeomans (2003)].

That these iterative structures extend to the full amplitudes is the content of the conjectures...

Brute force analysis of these conjectures is tough, because explicitly evaluating these integrals is an exceedingly difficult task. The simplest integral is:

$$\begin{aligned}
 -\frac{1}{2}st \quad \text{[Diagram: A square with four external lines extending from its corners]} &= -\frac{2}{\epsilon^2} + \frac{1}{4}L^2 + \frac{2\pi^2}{3} + \epsilon \left[-H_{001}(x) - LH_{01}(x) \right. \\
 &\quad \left. -\frac{1}{2}L^2H_1(x) - \frac{\pi^2}{2}H_1(x) + \frac{11\pi^2}{12}L + \frac{17\zeta(3)}{3} \right] \\
 &+ \epsilon^2 \left[H_{0001}(x) + H_{0011}(x) + H_{0101}(x) + H_{1001}(x) - \frac{1}{2}LH_{001}(x) \right. \\
 &\quad \left. -LH_{011}(x) - LH_{101}(x) + \frac{1}{2}L^2H_{11}(x) + \frac{\pi^2}{2}H_{11}(x) + \frac{1}{12}L^3H_1(x) \right. \\
 &\quad \left. -\zeta(3)H_1(x) + \frac{\pi^2}{4}LH_1(x) + \frac{1}{64}L^4 + \frac{\pi^2}{24}L^2 - \frac{\zeta(3)}{2}L + \frac{41\pi^4}{720} \right] \\
 &+ \epsilon^3 [37 \text{ terms}] + \epsilon^4 [79 \text{ terms}] + \mathcal{O}(\epsilon^5)
 \end{aligned}$$

where $L = \ln(x)$ and $x = t/s$. Adapted from [\[Bern, Dixon, Smirnov \(05/05\)\]](#)

Some New Loop Technology

Clearly, new technology is needed to explore these kinds of iterative structures more easily at higher loops...

I will now explain a method which allows these relations to be studied **without the need to fully evaluate any loop integrals** [Cachazo, M.S., Volovich (01/06, and to appear)].

Some New Loop Technology

STEP 1. We observe that any dimensionally regulated L -loop four-particle Feynman integral can be written in the form (Mellin-Barnes representation)

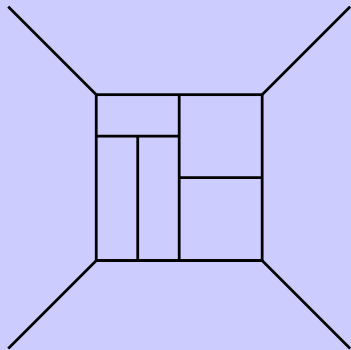

$$= \int_{-i\infty}^{+i\infty} dy x^y F(y, \epsilon), \quad \text{where } x = t/s,$$

for some function $F(y, \epsilon)$, which is relatively easy to determine—it follows algebraically from the formula for the Feynman integral. For example,

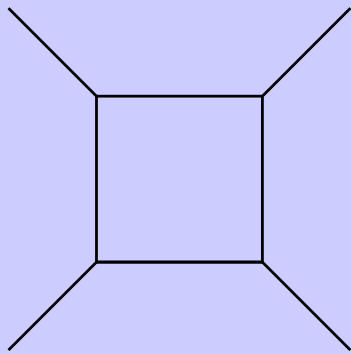

$$\implies F(y, \epsilon) = \Gamma(1 + \frac{1}{2}\epsilon + y) \Gamma^2(y - \frac{1}{2}\epsilon) \Gamma^2(-y - \frac{1}{2}\epsilon) \Gamma(1 - \frac{1}{2}\epsilon - y).$$

The final integral over y is the really nasty one.

Some New Loop Technology

STEP 1. Any four-particle integral = $\int dy x^y F(y, \epsilon)$.

STEP 2. If we want to study some iterative equation, it is clearly tempting to try to collect all of the terms appearing in some relation inside one y integral, and then expand through $\mathcal{O}(\epsilon)$ **under the y integral**.

This looks impossible, because $F(y, \epsilon)$ has poles which collide with the integration contour $\text{Re}(y) = 0$ at $\epsilon = 0$, e.g.

$$F(y, \epsilon) = \Gamma(1 + \frac{1}{2}\epsilon + y)\Gamma^2(y - \frac{1}{2}\epsilon)\Gamma^2(-y - \frac{1}{2}\epsilon)\Gamma(1 - \frac{1}{2}\epsilon - y).$$

This signals that expanding in ϵ and performing the y integral **do not commute**—we are not allowed to expand in ϵ under the integral. We call these annoying poles **obstructions**.

Some New Loop Technology

STEP 1. Any four-particle integral = $\int dy x^y F(y, \epsilon)$.

STEP 2. Collect all integrals under a single y integral.

STEP 3. Kill all obstructions by means of a suitably chosen linear differential operator, e.g.

$$\left(\left(x \frac{d}{dx} \right)^2 - \epsilon^2 \right)^2 \int_{-i\infty}^{+i\infty} dy x^y F(y, \epsilon) = \int_{-i\infty}^{+i\infty} dy x^y (y^2 - \epsilon^2)^2 F(y, \epsilon)$$

Now the poles at $y = \pm\epsilon$ are completely removed, and it is safe to expand in ϵ under the y integral.

Different integrals can have different numbers of obstructions; choose a differential operator \mathcal{L} which kills all of them...

Some New Loop Technology

STEP 1. Any four-particle integral = $\int dy x^y F(y, \epsilon)$.

STEP 2. Collect all integrals under a single y integral.

STEP 3. Kill all obstructions with a differential operator \mathcal{L} .

STEP 4. We must fix the ambiguity introduced by acting with \mathcal{L} . Fortunately, the types of operators which we need to use have very simple kernels.

For example, at two loops, the only ambiguity is

$$\frac{a_1}{\epsilon^4} + \frac{a_2}{\epsilon^2} \ln^2 x + a_3 \ln^4 x + \mathcal{O}(\epsilon^2).$$

Three numbers are a very small price to pay in exchange for being able to unambiguously fix all polylog functions. In any case these numbers can be fixed using infrared and collinear limits.

Two Loops, Five Particles

All of this analysis applied to **four-particle** amplitudes, which are functions of a single variable $x = t/s$.

Five-particle amplitudes are already much more complicated. No expression for the two-loop amplitude is known, although a conjecture has been made [[Bern, Rozowsky and Yan \(1997\)](#)].

We have verified that the **parity-even** part of this conjecture satisfies the expected iterative relation. (The parity-odd part is unfortunately much more subtle.)

New Two-Loop Integrals

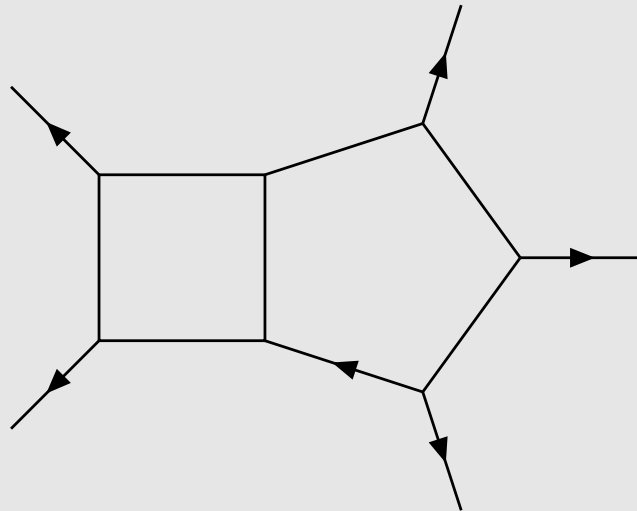
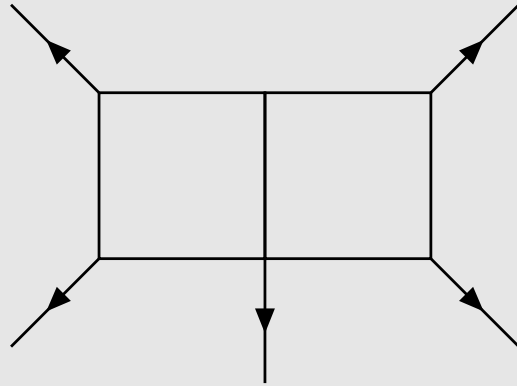

Summary

Recent insights into the mathematical structure of perturbative gauge theory has helped to make previously impossible calculations possible, and sometimes even simple.

Within a period of little over a year, tree-level Yang-Mills theory was (more or less) completely solved, as was supersymmetric Yang-Mills theory at one loop.

Prospects are good for significant progress on multiloop amplitudes, especially in the $\mathcal{N} = 4$ supersymmetric theory.