

Photons and Quantum Information Processing

Aephraim M. Steinberg

Centre for Quantum Info & Quantum Control

Institute for Optical Sciences

Dept. of Physics, University of Toronto

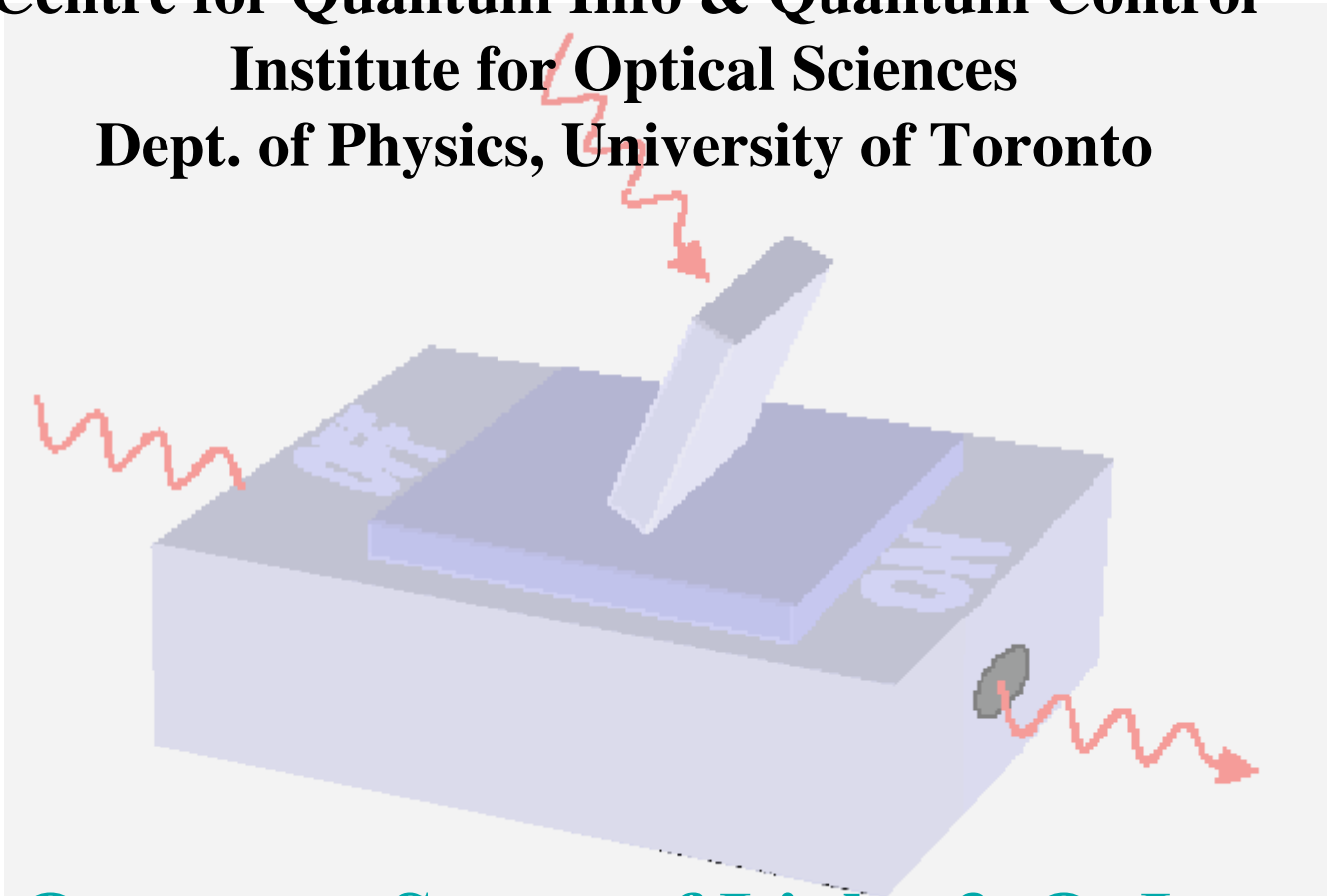

Talk 1: Quantum States of Light & Q. Interference

Talk 2: Quantum Measurement & Info. w/ Photons

Michigan Quantum Summer School 2008

Photons and Quantum Information Processing

Aephraim M. Steinberg

Centre for Quantum Info & Quantum Control

Institute for Optical Sciences

Dept. of Physics, University of Toronto

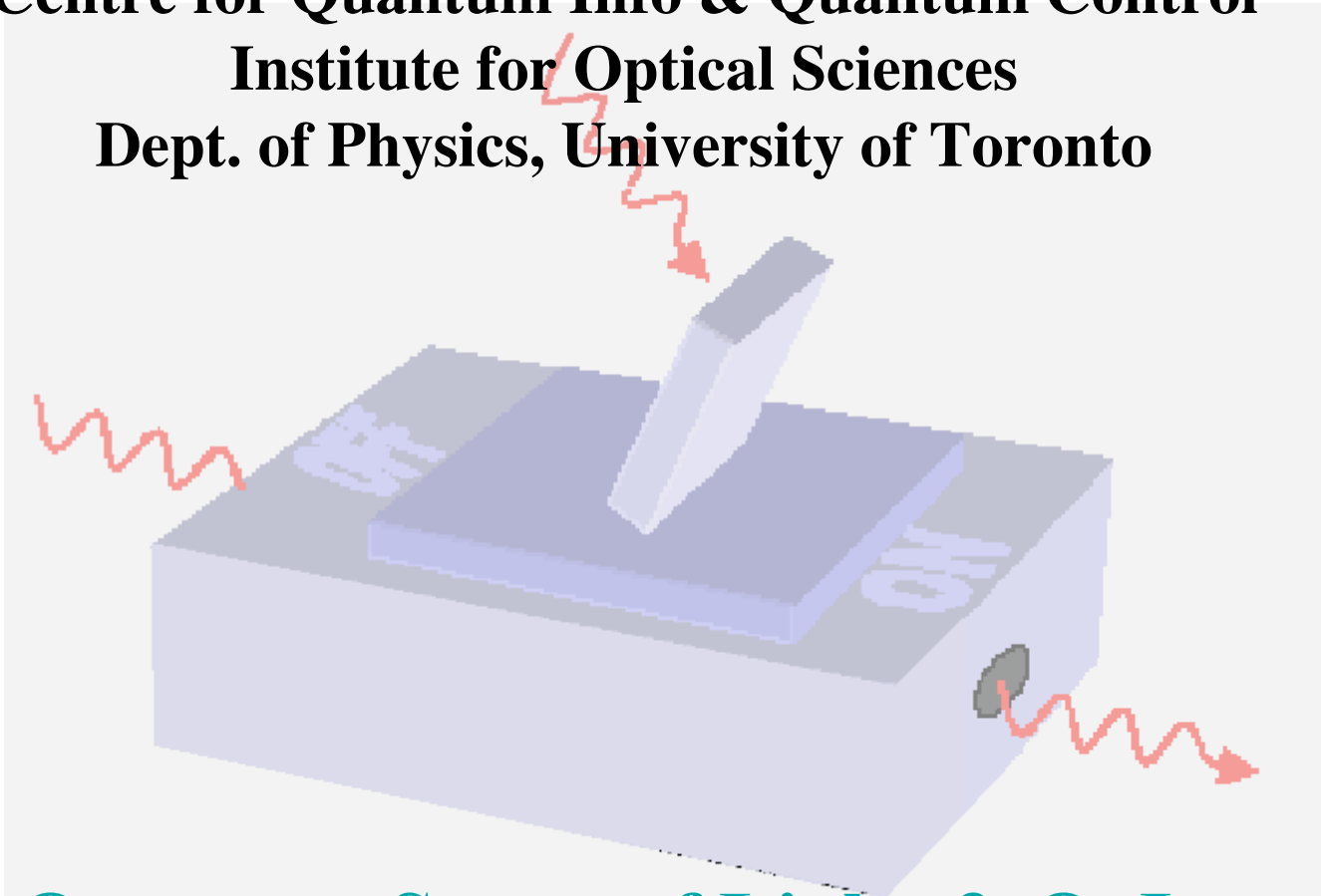

Talk 1: Quantum States of Light & Q. Interference
Talk 2: some leftover examples of Q. Interference, + Quantum Measurement & Info. w/ Photons

Michigan Quantum Summer School 2008

Hong-Ou-Mandel interferometer (do different photons interfere or not?)

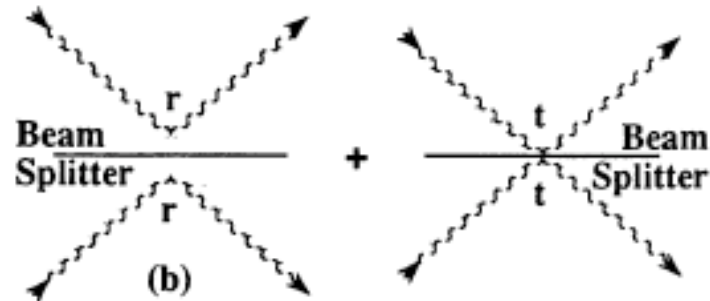
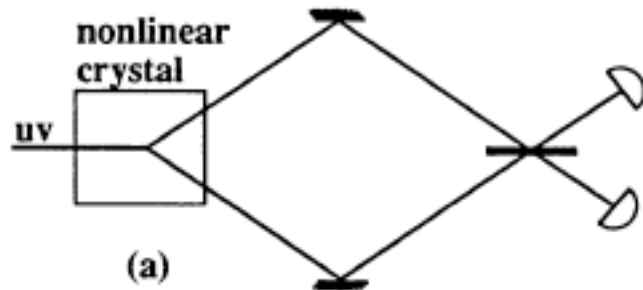

Remember: if you detect only one photon, the *other* photon "knows" where yours came from. Hence there is no interference (each detector sees 1/2 of the photons, irrespective of any phases or path-length differences).

But: if you detect *both* photons, there is no way to tell whether both were reflected or both were transmitted. $r^2+t^2 = (i^2 + 1^2)/2 = 0$.
(any lossless symmetric beam splitter has a $\pi/2$ phase shift between r and t .)

CAVEAT: there must *be* no way to tell which occurred.

If the paths aren't aligned right, no interference occurs.

If one photon reaches the beam splitter before the other, no interference occurs.

Hong, Ou, & Mandel, PRL 59, 2044 (1987)

the famous dip

In every experiment to date, the width of this feature is limited only by the bandwidth of the photons; in other words, the photons are as *tightly correlated* as they could possibly be given their own uncertainty in time ($\Delta t > 1/2\Delta\omega$).

$$|\Psi\rangle = \int d\omega' f(\omega') |\omega_0 + \omega'\rangle_s |\omega_0 - \omega'\rangle_i$$

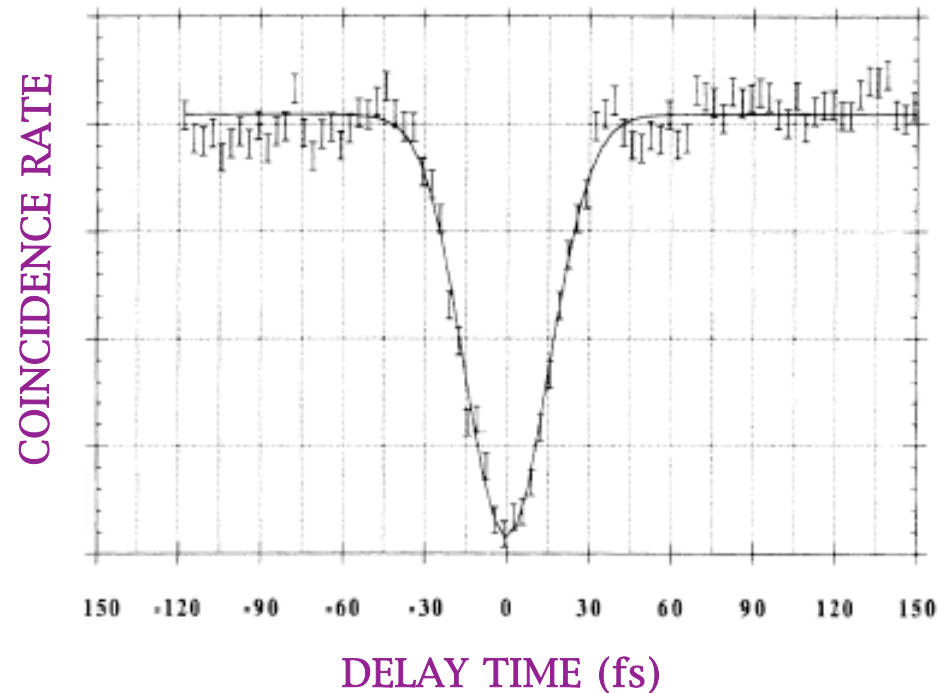

Instead of an amplitude for each frequency component of each beam there is an amplitude for each frequency-correlated *pair* of photons.

Each energy is uncertain, yet their sum is precisely defined.

Each emission time is uncertain, yet they are simultaneous.

Energy-entangled state, just as in original EPR proposal

A polarisation-based quantum eraser

Hong-Ou-Mandel interferometer:

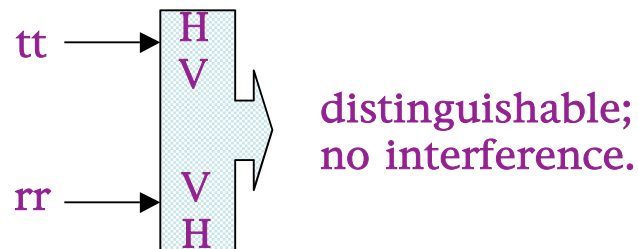
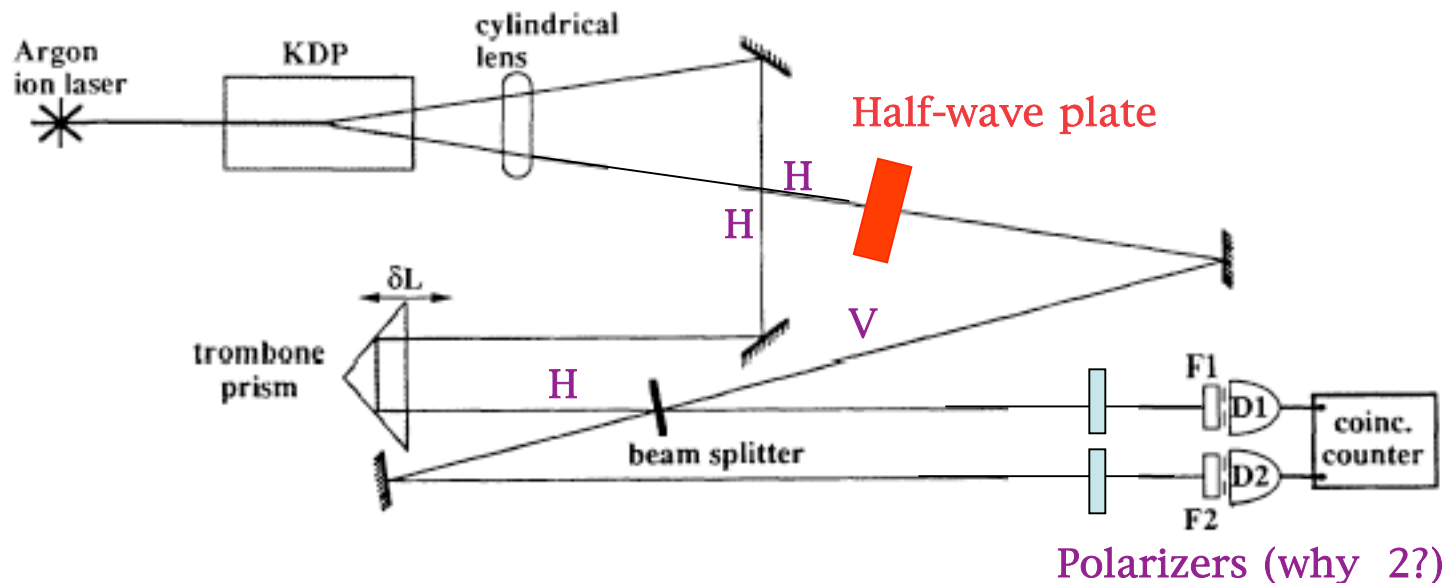

Interference going away...

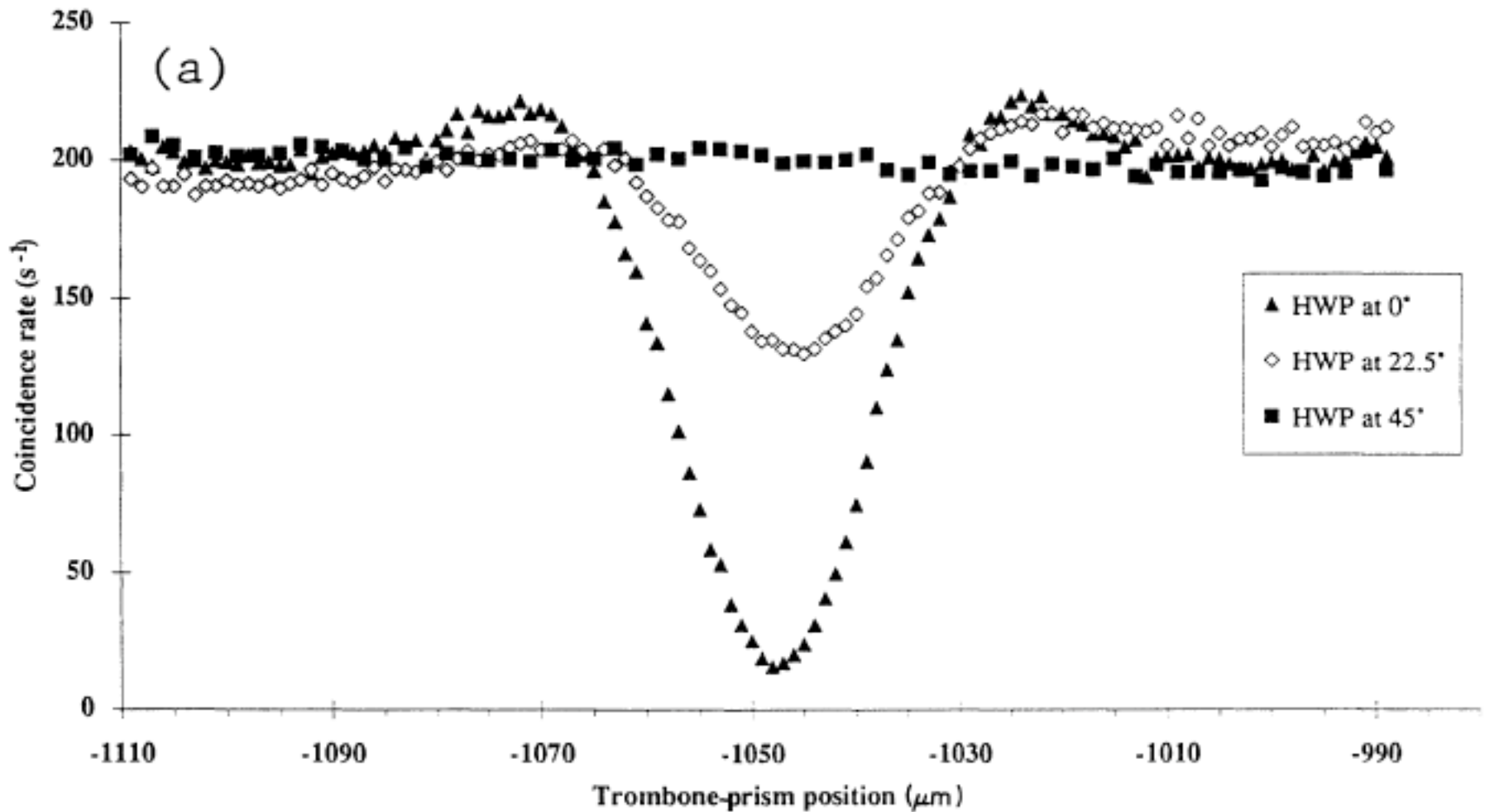

And coming back again!

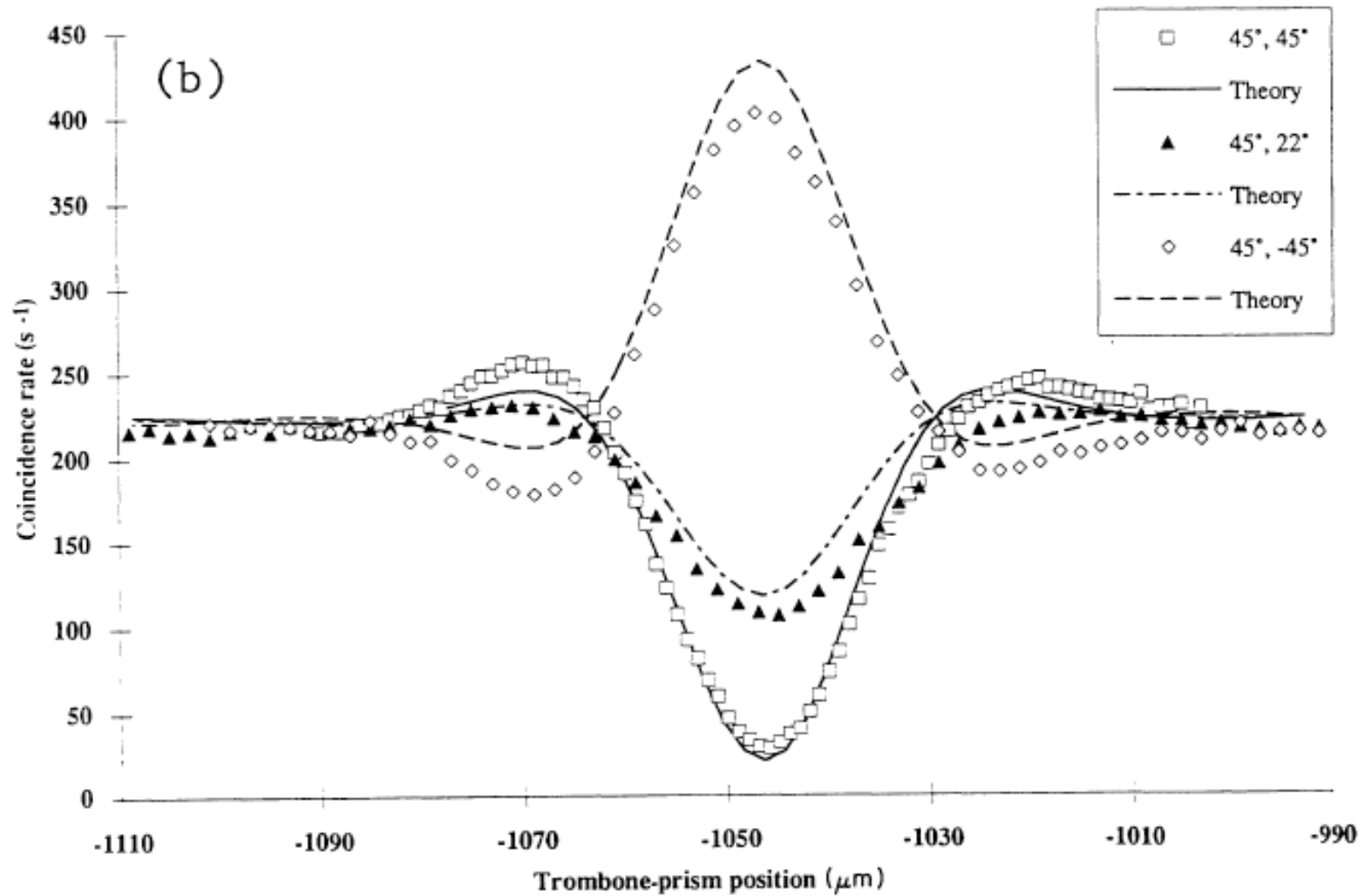

How complicated you have to make it sound if you want to get it published

We turn now to the general case with two polarizers set at arbitrary angles θ_1 and θ_2 .

$$\begin{aligned}
 P_c(0) &\approx \langle \psi | \hat{P}_{\text{pol},1}(\theta_1) \hat{P}_{\text{pol},2}(\theta_2) \hat{P}_{c,\text{red}}' \hat{P}_{\text{pol},2}(\theta_2) \hat{P}_{\text{pol},1}(\theta_1) | \psi \rangle_{\Delta x=0} \\
 &= \frac{1}{2} [\langle 1_1^H 1_2^{H+\phi} | - \langle 1_1^{H+\phi} 1_2^H |] (| 1_1^{H+\theta_1} \rangle \langle 1_1^{H+\theta_1} |) (| 1_2^{H+\theta_2} \rangle \langle 1_2^{H+\theta_2} |) (\hat{a}_{1,H}^\dagger \hat{a}_{1,H} + \hat{a}_{1,V}^\dagger \hat{a}_{1,V}) \\
 &\quad \times (\hat{a}_{2,H}^\dagger \hat{a}_{2,H} + \hat{a}_{2,V}^\dagger \hat{a}_{2,V}) (| 1_2^{H+\theta_2} \rangle \langle 1_2^{H+\theta_2} |) (| 1_1^{H+\theta_1} \rangle \langle 1_1^{H+\theta_1} |) \frac{1}{2} [| 1_1^H 1_2^{H+\phi} \rangle - | 1_1^{H+\phi} 1_2^H \rangle] .
 \end{aligned}$$

Using Eq. (A2), one can expand $|\tilde{\psi}\rangle_{\Delta x=0} = \hat{P}_{\text{pol},2}(\theta_2) \hat{P}_{\text{pol},1}(\theta_1) |\psi\rangle_{\Delta x=0}$. After simplifying algebra one finds

$$\begin{aligned}
 |\tilde{\psi}\rangle_{\Delta x=0} &= | 1_1^H 1_2^H \rangle \cos\theta_1 \cos\theta_2 \sin(\theta_2 - \theta_1) \sin\phi + | 1_1^V 1_2^V \rangle \sin\theta_1 \sin\theta_2 \sin(\theta_2 - \theta_1) \sin\phi \\
 &\quad + | 1_1^H 1_2^V \rangle \cos\theta_1 \sin\theta_2 \sin(\theta_2 - \theta_1) \sin\phi + | 1_1^V 1_2^H \rangle \sin\theta_1 \cos\theta_2 \sin(\theta_2 - \theta_1) \sin\phi .
 \end{aligned}$$

It then follows that

$$P_c(0) \approx \langle \tilde{\psi} | \hat{P}_{c,\text{red}}' | \tilde{\psi} \rangle_{\Delta x=0} = \sin^2\phi \sin^2(\theta_2 - \theta_1) ,$$

which is the more general case of Eq. (13).

"Calculations are for those who don't trust their intuition."

Simple collapse picture

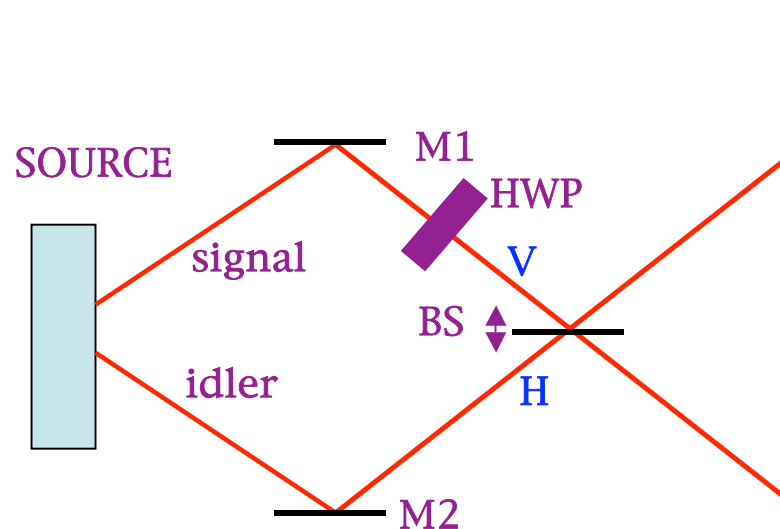

Suppose I detect a photon at θ here. This collapses my photon into $H \cos \theta + V \sin \theta$. This means an amplitude of $\cos \theta$ that the *other* photon was V, and of $\sin \theta$ that it was H. Being careful with reflection phase shifts, this collapses the other output port into $V \cos \theta - H \sin \theta$, which of course is just $(\theta + \pi/2)$.

Here I'm left with a photon 90° away from whatever I detected. Now I just have linear optics to think about.

Of course I get sinusoidal variation as I rotate this polarizer.

"...and experiment is for those who don't trust their calculations."

Polarisation-dependence of rate at centre of H-O-M dip...

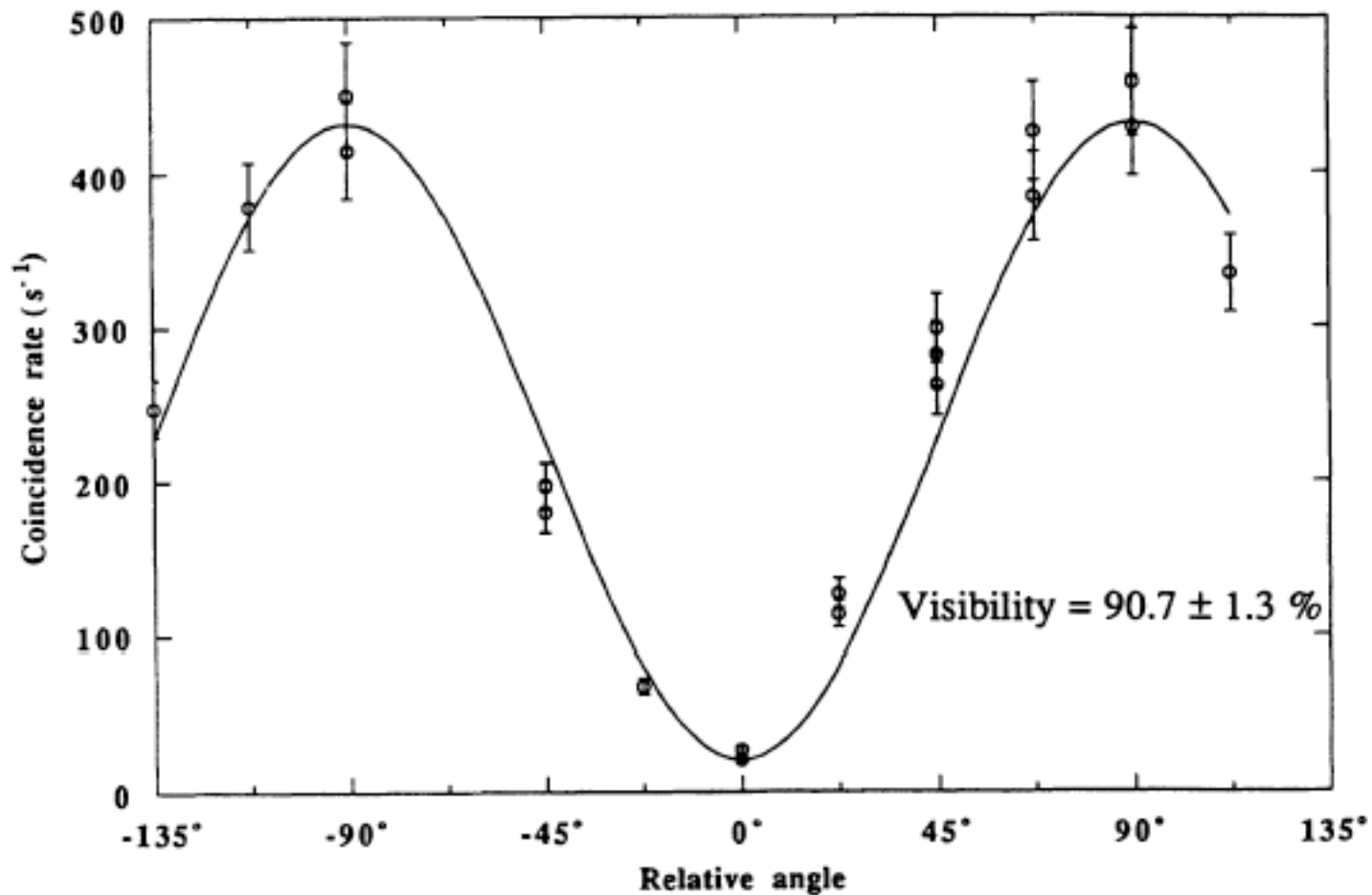

But did I *need* to invoke collapse? (and if so, which photon did the work?)

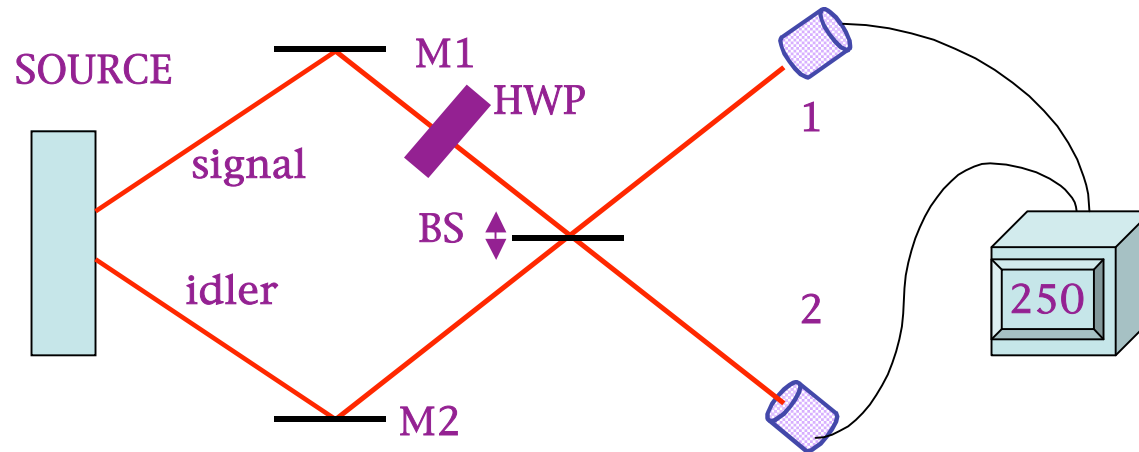

$$\begin{aligned}
 V_s H_i &\longrightarrow (V_2 + i V_1) (H_1 + i H_2) \\
 &= \underline{\underline{1 H_2 V_1 - 1 V_2 H_1}} + i [1 H_1 V_1 + 2 H_2 V_2]
 \end{aligned}$$

In coincidence, only see $|HV\rangle - |VH\rangle$... that famous EPR-entangled state.
Of course we see nonlocal correlations between the polarisations.

These joint-detection probabilities can be calculated directly, without collapse;
add the amplitudes from HV and VH: $P(\theta_1, \theta_2) = |\cos(\theta_1)\sin(\theta_2) - \sin(\theta_1)\cos(\theta_2)|^2$
 $= \sin^2(\theta_1 - \theta_2)$.

This *is* the Bell-Inequality experiment done by Shih&Alley and Ou&Mandel.

"FLASH" !?

So, does Bob immediately know what Alice chose to measure?

NO! If she chose "dirtiness," she already knows whether his is clean or dirty – but the answer was random.

If she chose "colour," then she knows whether his is pink or not pink – so its "dirtiness" is undetermined.

Bob gets a random answer no matter what... but was the random answer known before he made his measurement?

Nick Herbert: if he made 100 copies ("clones") of his photon before measuring, then he could see whether they all have the same dirtiness (because Alice already knew it), or whether each one was random (because Alice measured "colour").

They could communicate faster than light!

Cloning



**Copying something is like measuring what it is first,
and then reproducing it –
but remember that measurements disturb things.
You can't copy a particle's position and a momentum
at the same time.**

Why is cloning impossible?

1: Because if it were possible, we could communicate faster than c , reducing the problem to one previously shown to be impossible.

2: Because it would duplicate information, and I told you that unitary evolution conserves information (& you believe me).

Suppose the opposite:

$$\begin{aligned}U|a\rangle &\equiv |a'\rangle = |a\rangle|a\rangle \\U|b\rangle &\equiv |b'\rangle = |b\rangle|b\rangle \\ \langle b'|a'\rangle &= (\langle b|a\rangle)^2\end{aligned}$$
$$\langle b'|a'\rangle = \langle bU^\dagger|Ua\rangle = \langle b|a\rangle$$

3: The superposition principle shows that if you have cloning in one basis, you *must* not have it in others:

$$\begin{aligned}|H\rangle &\rightarrow |H\rangle|H\rangle \\|V\rangle &\rightarrow |V\rangle|V\rangle \\|H\rangle + |V\rangle &\rightarrow |H\rangle|H\rangle + |V\rangle|V\rangle \\ &\neq (|H\rangle + |V\rangle) (|H\rangle + |V\rangle)\end{aligned}$$

Quantum Cryptography

Copyright 2003 by Randy Glasbergen.
www.glasbergen.com



“We don’t need to worry about information security or message encryption. Most of our communications are impossible to understand in the first place.”

The foundations of cryptography

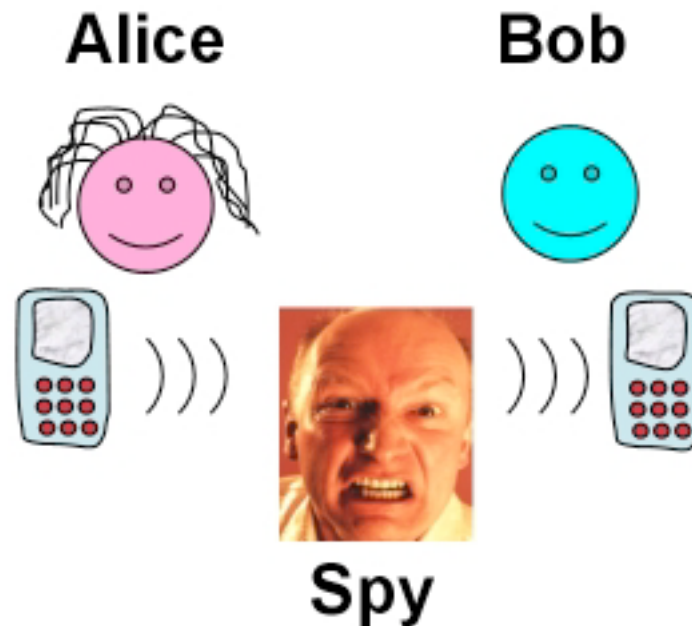







The only provably secure way to send secrets:
the "one-time pad." Alice and Bob share a *random*
"key", which is AS LONG AS THE ENTIRE MESSAGE.
They never reuse it. (Soviets made this mistake.)

Problem: How to be sure "Eve" didn't get a copy of the key?

The Bennett-Brassard Protocol (1984)

Heisenberg to the rescue!
Photons have "polarisation"

You can measure whether one is  or 
OR you can measure whether it's  or 

But if it's 
and you measure HV, the result is random; and vice versa. 

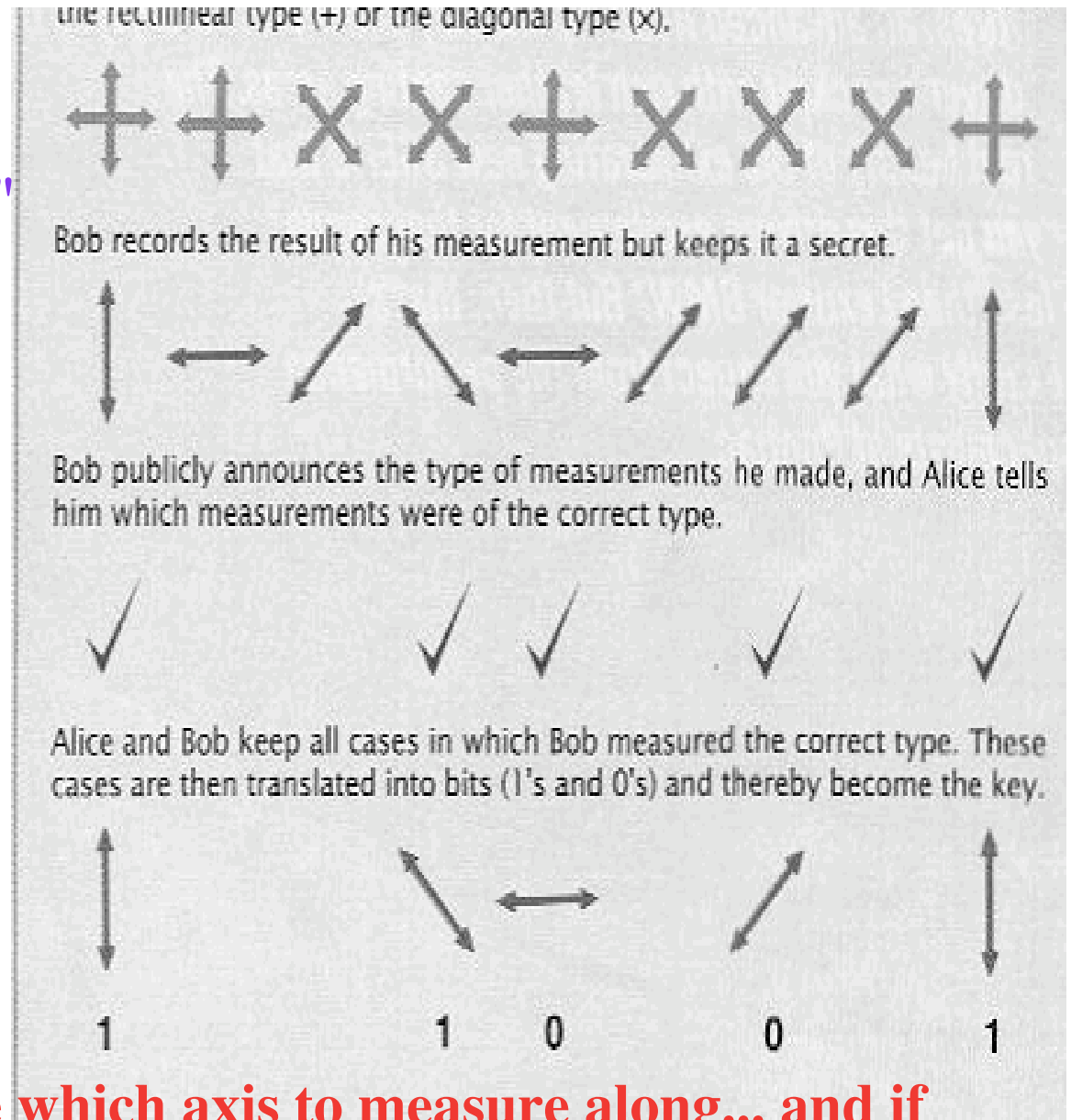

Eve can't know in advance which axis to measure along... and if she guesses wrong, she destroys the correlations Alice & Bob test.

This random string of bits can be used as a secret key...

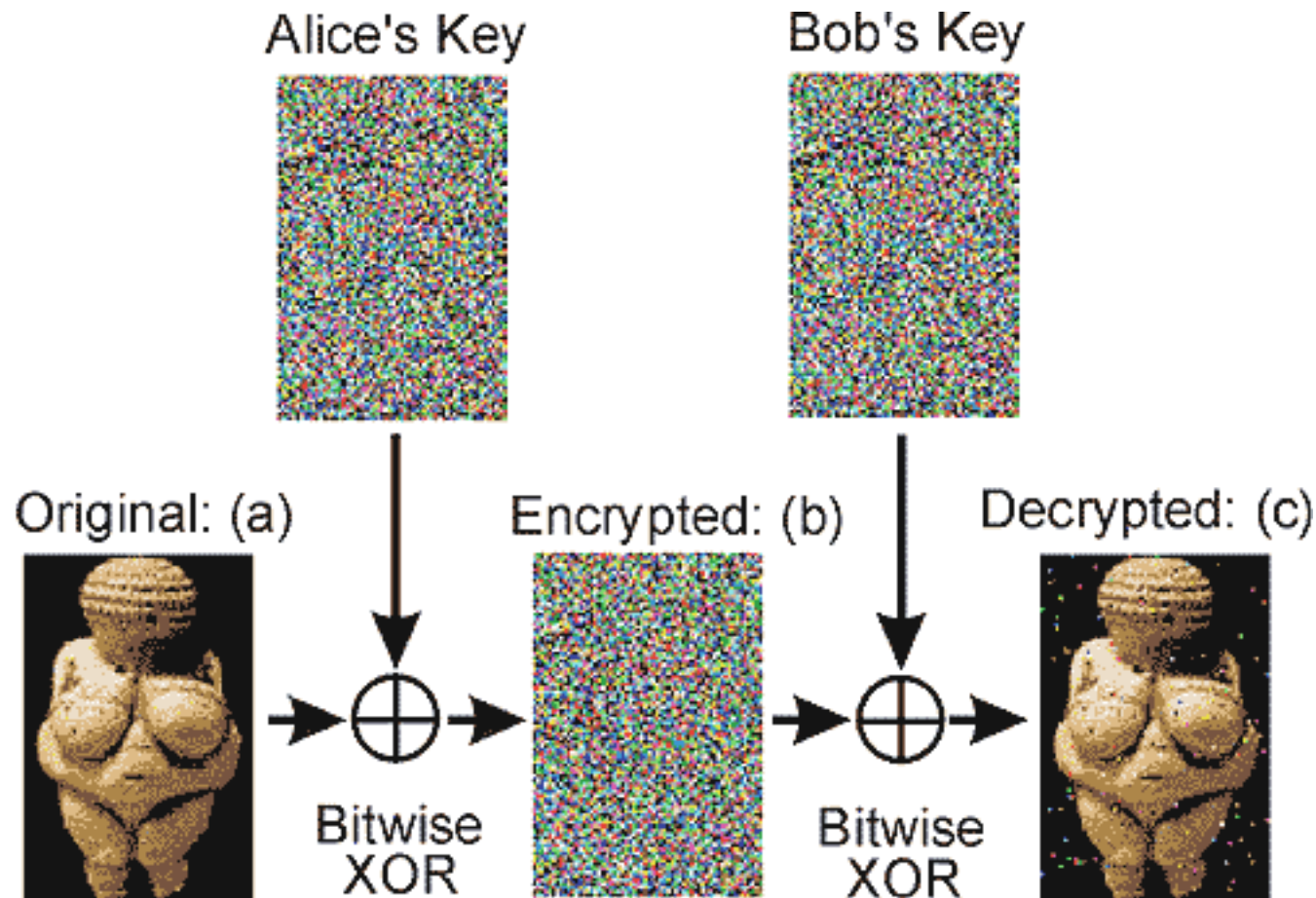

Hong-Ou-Mandel Interference as a Bell-state filter

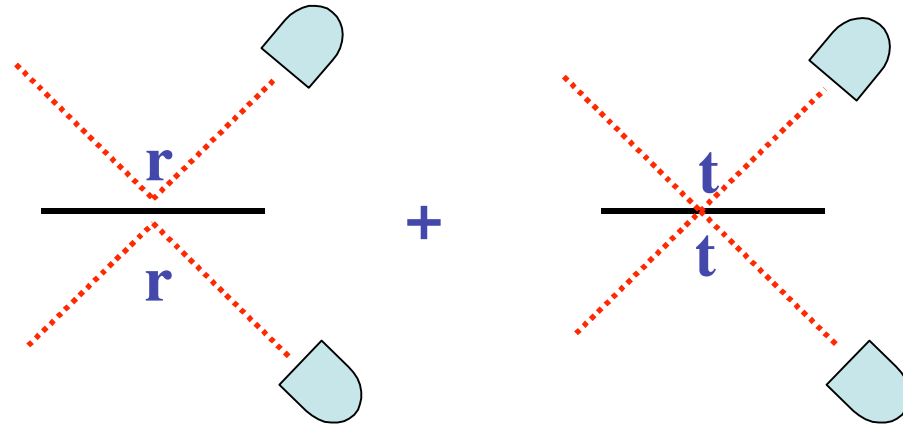

$r^2+t^2 = 0$; total destructive interf. (if photons indistinguishable).

If the photons begin in a **symmetric** state, no coincidences.

{Exchange effect; cf. behaviour of fermions in analogous setup!}

The only *antisymmetric* state is the singlet state $|HV\rangle - |VH\rangle$, in which each photon is unpolarized but the two are orthogonal. Nothing else gets transmitted.

This interferometer is a "Bell-state filter," used for quantum teleportation and other applications.

Quantum Teleportation

Bennett *et al.*, Phys. Rev. Lett. 70, 1895 (1993)

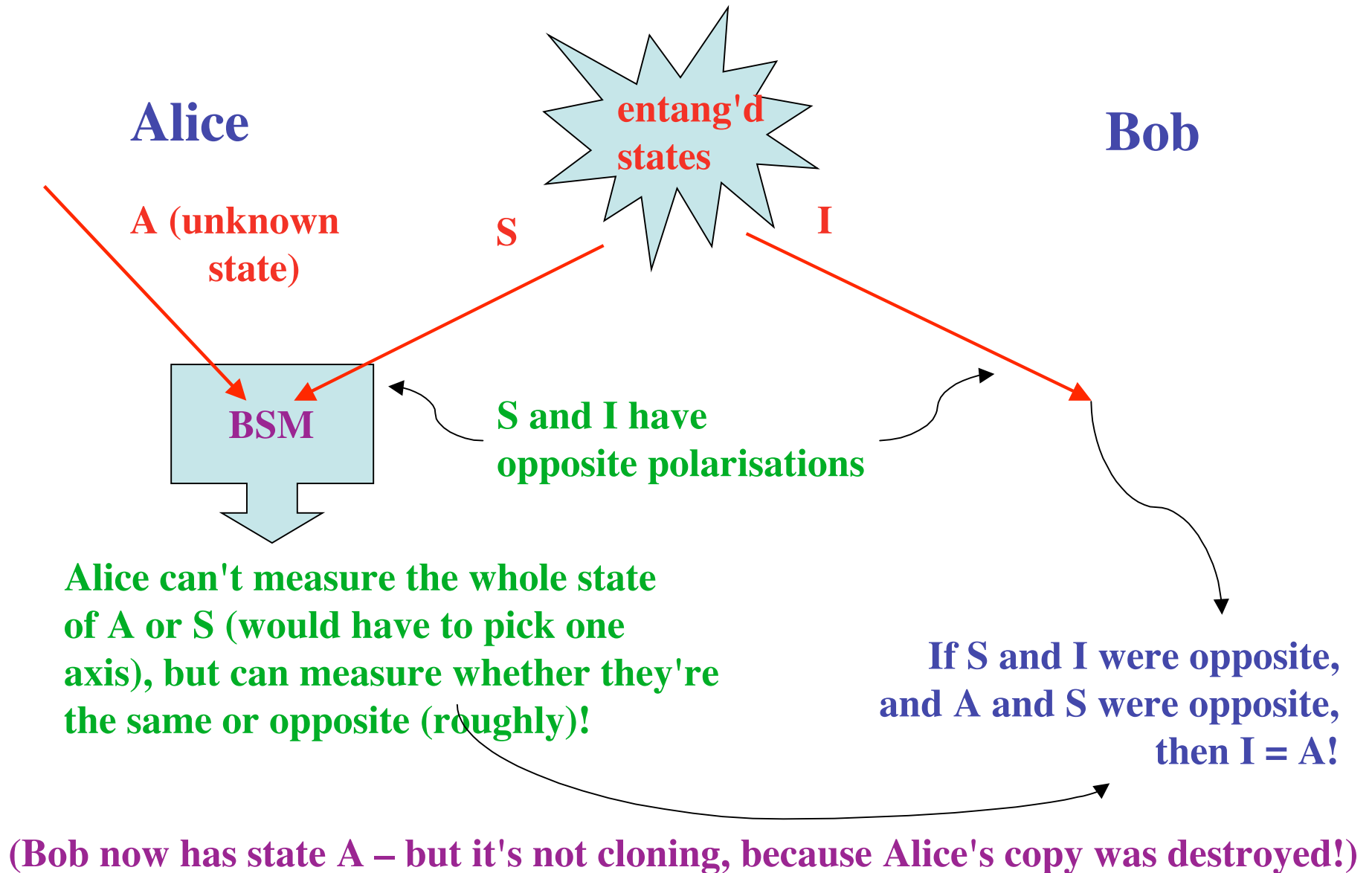

Quantum Teleportation (expt)

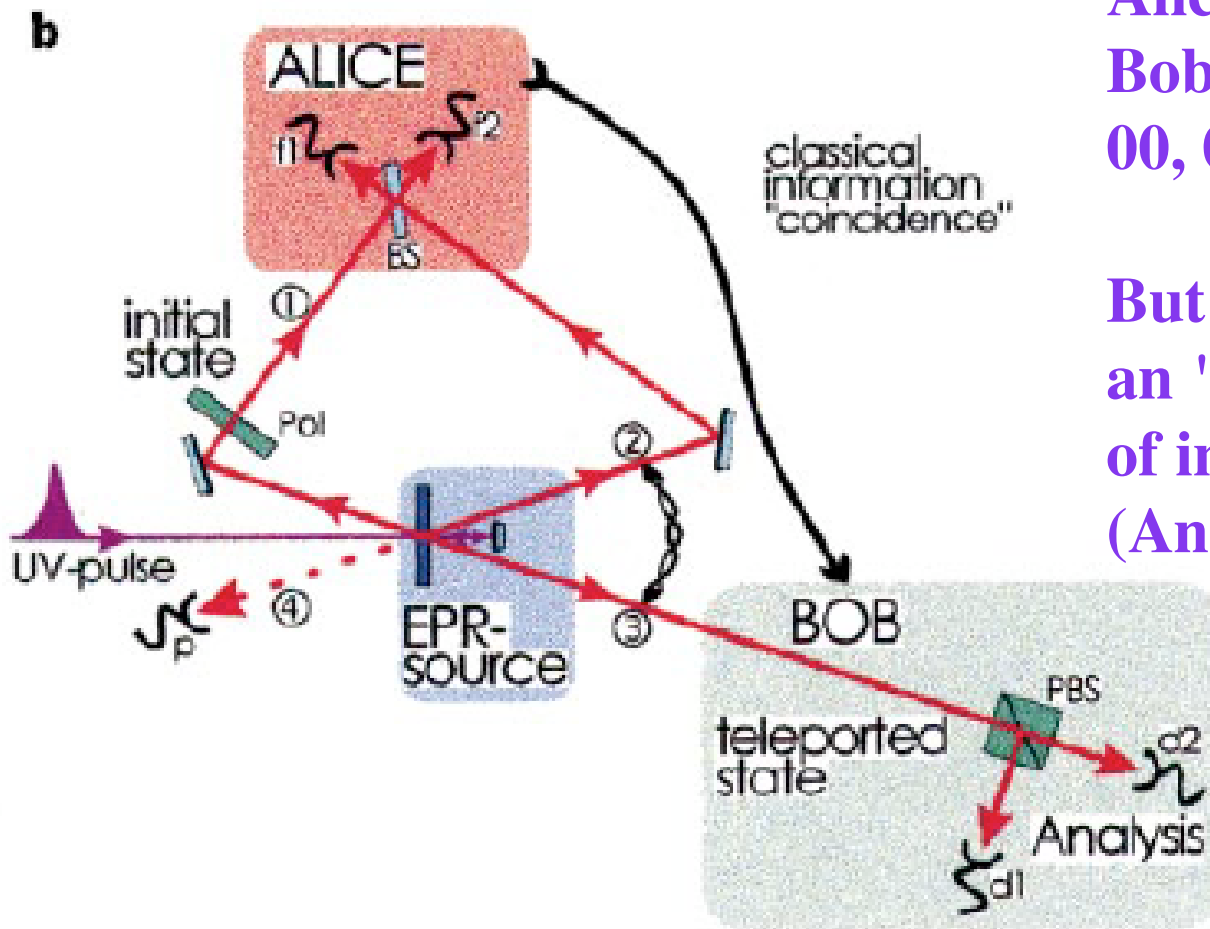

Alice has to send
Bob 2 bits of info:
00, 01, 10, or 11.

But Bob receives
an "infinite" amount
of information!
(Any angle in space).

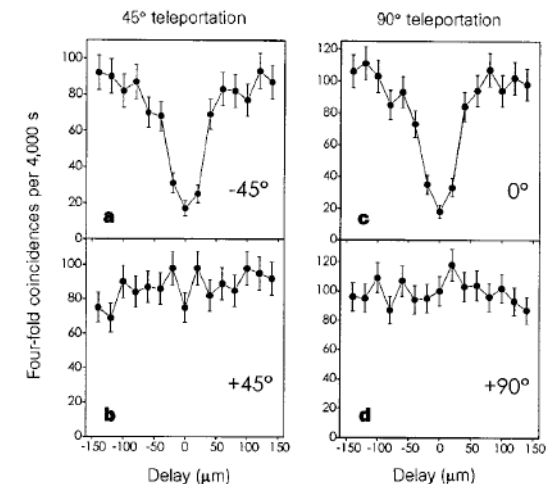

Bouwmeester *et al.*, Nature 390, 575 (97)

A digression: Polynomial Functions of a Density Matrix

[T. A. Brun, QIC 4, 401 ('04)]

- Often, only want to look at a single figure of merit of a state (i.e. tangle, purity, etc...)
- Would be nice to have a method to measure these properties without needing to carry out full QST.
- Todd Brun showed that m^{th} degree polynomial functions of a density matrix $f_m(\rho)$ can be determined by measuring a single joint observable involving m identical copies of the state.

$$f_m(\rho) = \langle A_f \rangle = \text{Tr}(A_f \rho^{\otimes m})$$

Linear Purity of a Quantum State

Adamson, Shalm, AMS, PRA 75, 012104 (07)

$$P = \text{Tr}(\rho^2)$$

- For a pure state, $P=1$
- For a maximally mixed state, $P=(1/n)$
- Quadratic \rightarrow 2-particle msmt needed

Measuring the purity of a qubit

- Need two identical copies of the state
- Make a joint measurement on the two copies.
- In Bell basis, projection onto the singlet state

$$P = 1 - 2 \langle |\Psi^-\rangle \langle \Psi^-| \rangle$$



Singlet-state probability can be measured by a singlet-state filter (HOM)

HOM as Singlet State Filter

Pure State on either side = 100% visibility

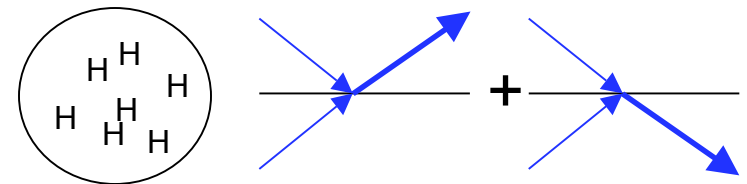

Mixed State = 50% visibility

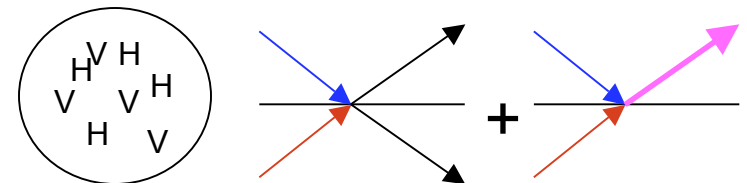

HOM Visibility = Purity

SUBTLETIES! How do you actually make a mixed state?

Experimentally Measuring the Purity of a Qubit

- Use Type 1 spontaneous parametric downconversion to prepare two identical copies of a quantum state
- Vary the purity of the state
- Use a HOM to project onto the singlet
- Compare results to QST

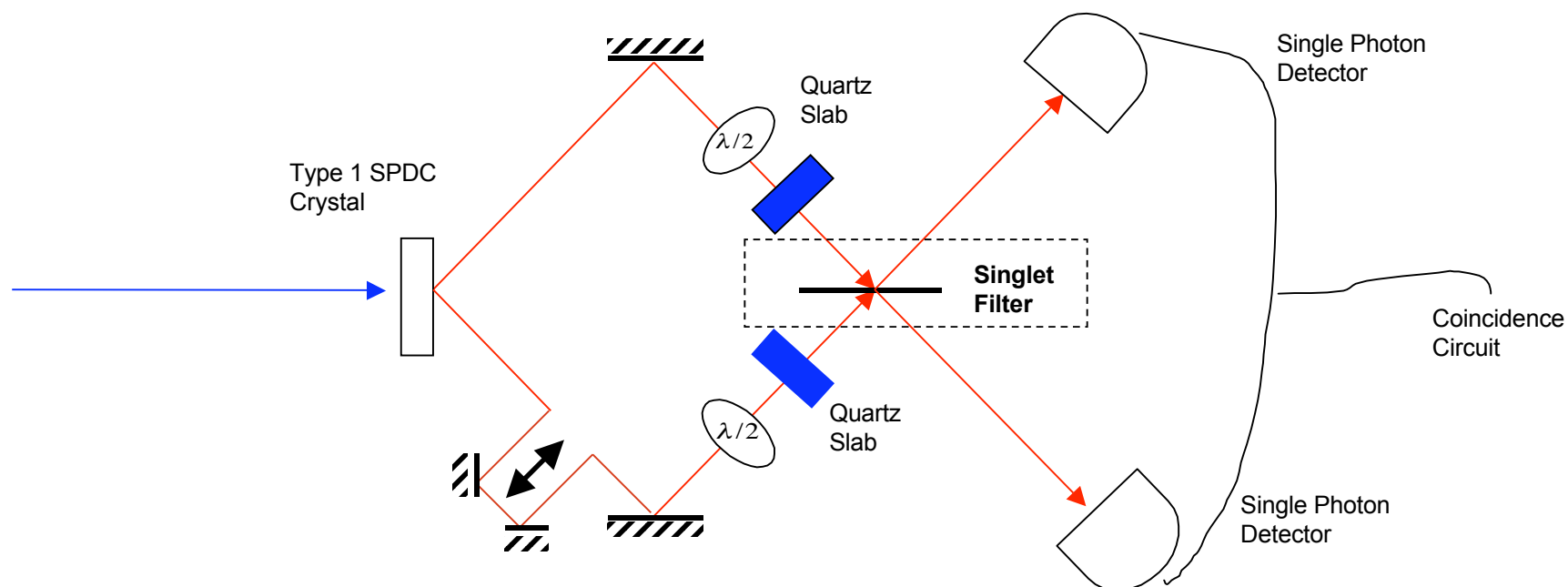

Results For a Pure State

Prepared the state $|+45\rangle$

Measured Purity
from Singlet State
Measurement
 $P=0.92\pm 0.02$

Measured Purity
from QST
 $P=0.99\pm 0.01$

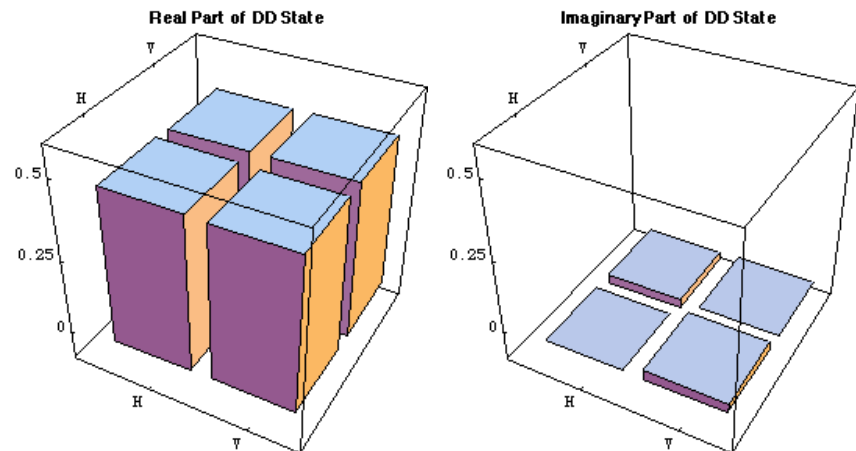
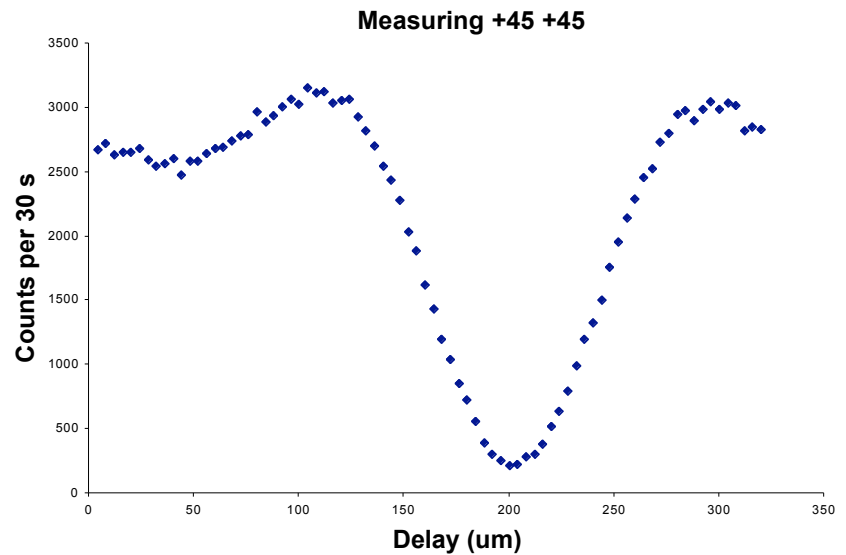

Preparing a Mixed State ?

Can a birefringent delay decohere polarization (when we trace over timing info) ?

[cf. J. B. Altepeter, D. Branning, E. Jeffrey, T. C. Wei, and P. G. Kwiat, Phys. Rev. Lett., 90, 193601]

Case 1: Same birefringence in each arm

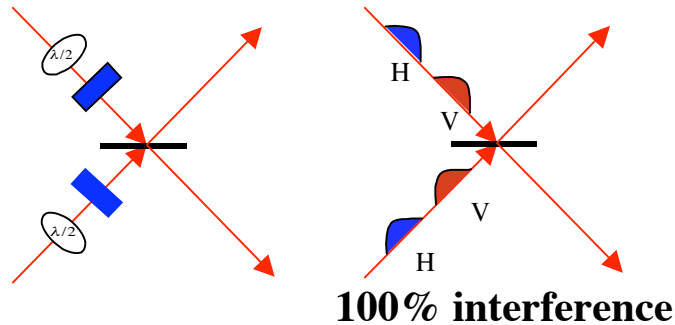

Visibility = $(90 \pm 2) \%$

Case 2: Opposite birefringence in each arm

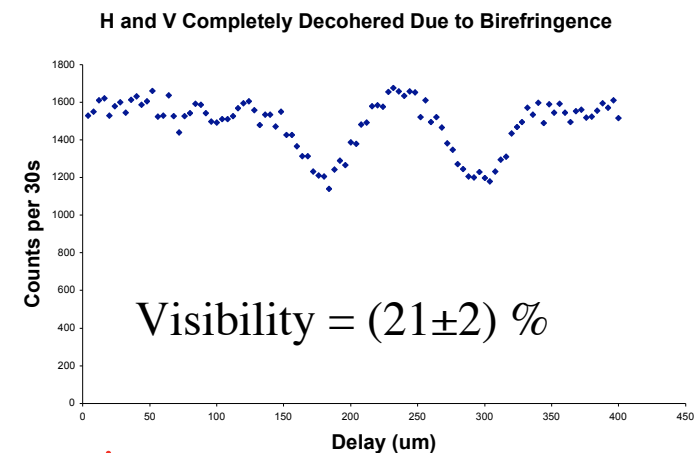
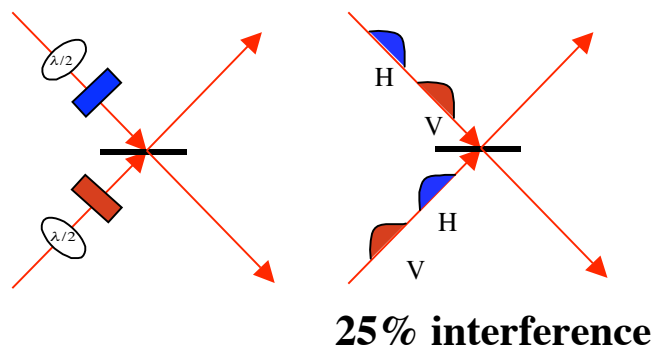

The HOM isn't actually insensitive to timing information.

Not a singlet filter, but an “Antisymmetry Filter”

- The HOM is not merely a polarisation singlet-state filter
- Problem:
 - Used a degree of freedom of the photon as our bath instead of some external environment
 - The HOM is sensitive to all degrees of freedom of the photons
 - The HOM acts as an antisymmetry filter on the entire photon state
- Y Kim and W. P. Grice, Phys. Rev. A **68**, 062305 (2003)
- S. P. Kulik, M. V. Chekhova, W. P. Grice and Y. Shih, Phys. Rev. A **67**, 01030(R) (2003)

Shaken, not stirred

Randomly rotate the half-waveplates to produce $|45\rangle$ and $|-45\rangle$

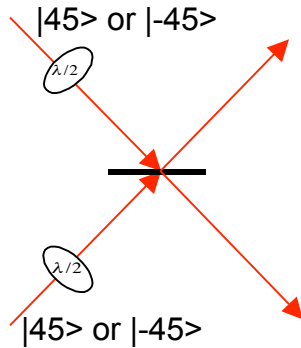

Use LCD waveplates to introduce a random phase shift between orthogonal polarizations to produce a variable degree of coherence

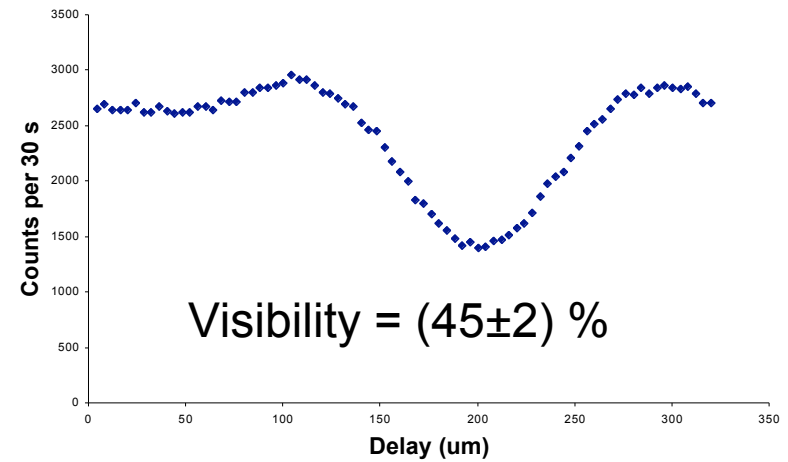

Could produce a “better” maximally mixed state by using four photons. Similar to Paul Kwiat’s work on Remote State Preparation.

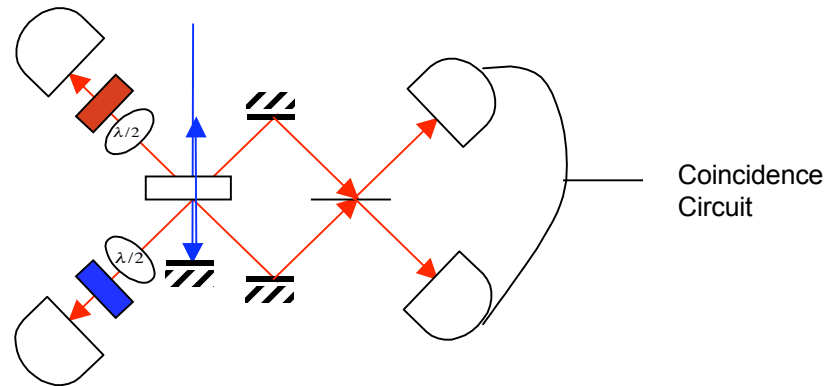

Another digression: Is SPDC really the time-reverse of SHG?

(And if so, then why doesn't it exist in classical e&m?)

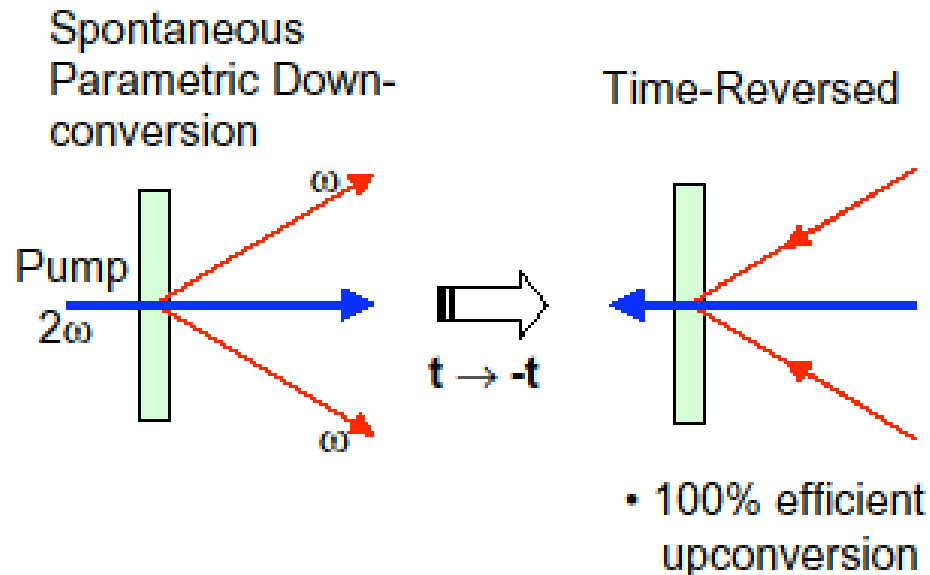

The probability of 2 photons upconverting in a typical nonlinear crystal is roughly 10^{-10} (as is the probability of 1 photon spontaneously down-converting).

Quantum Interference

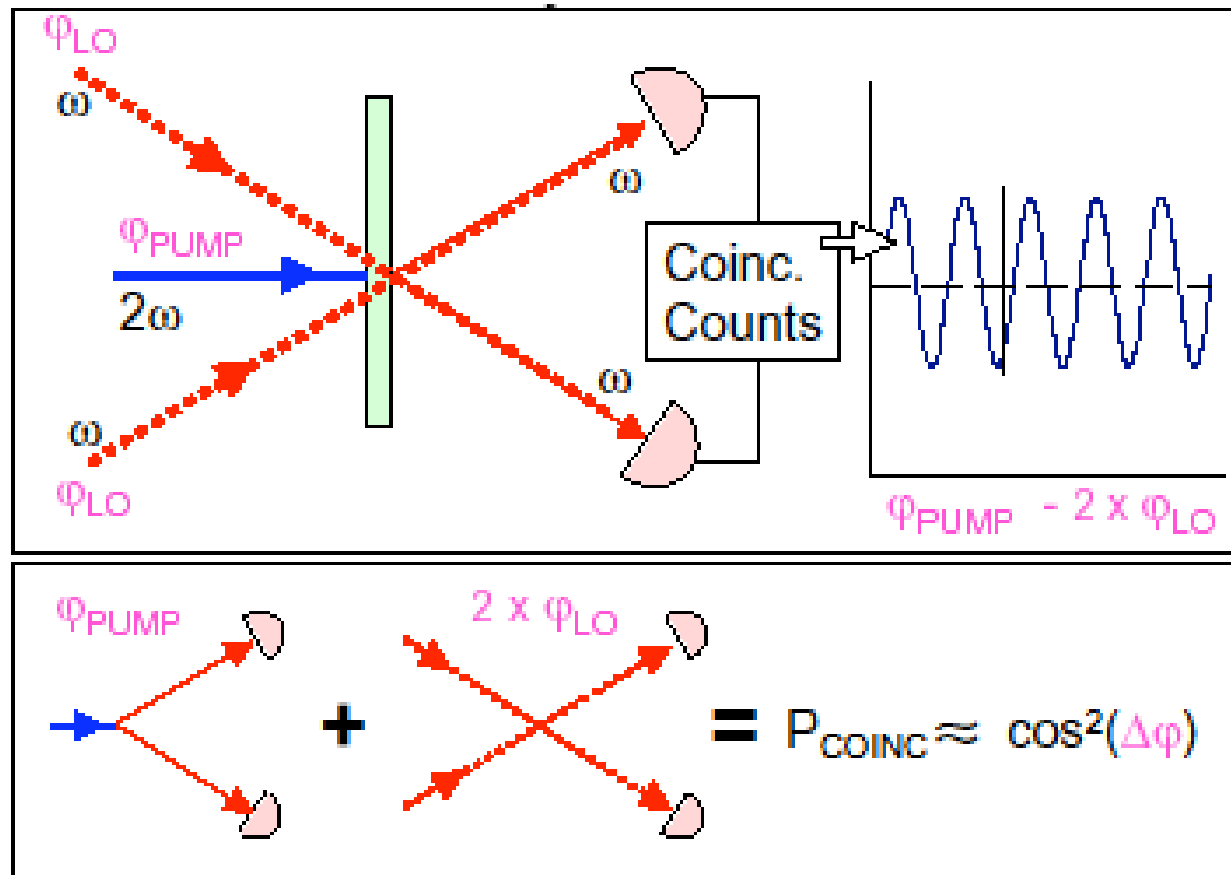

Type-II down-conversion

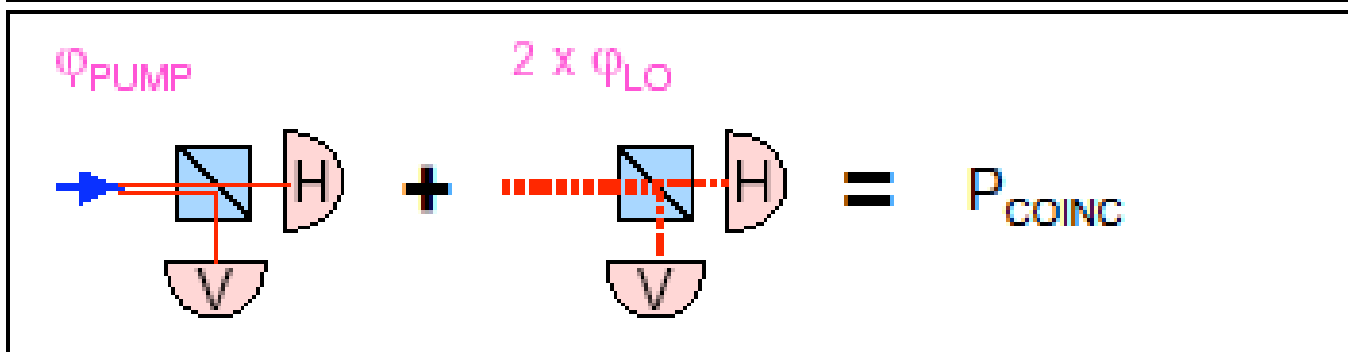
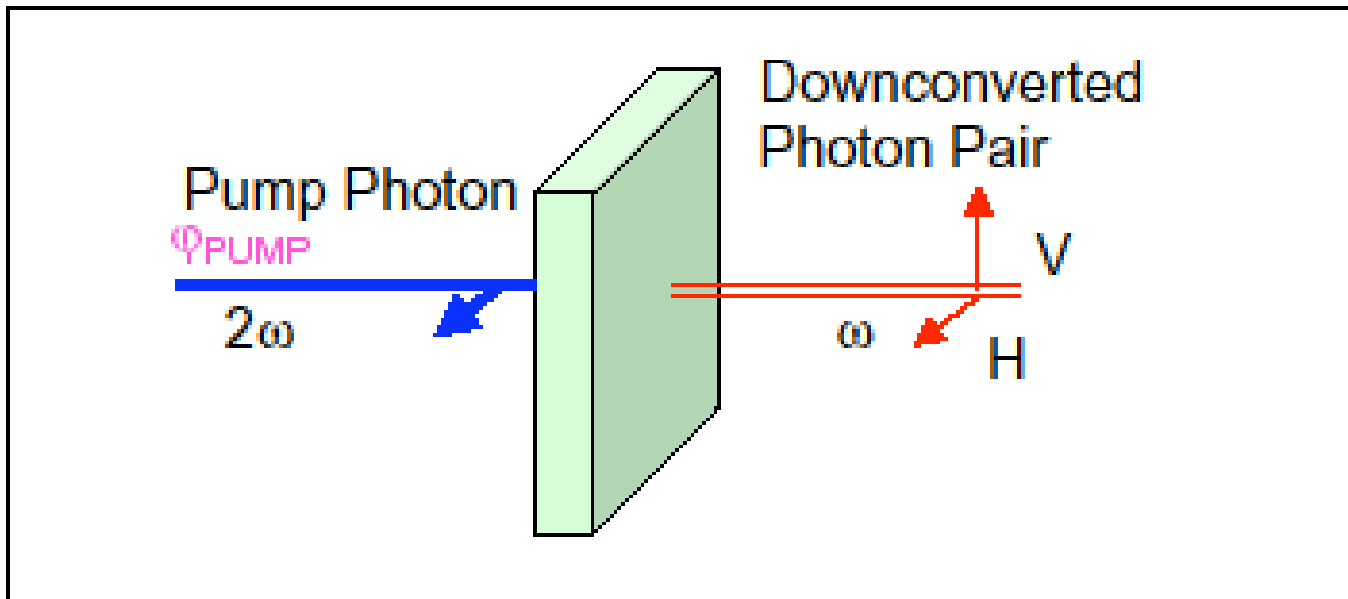

2-photon "Switch": experiment

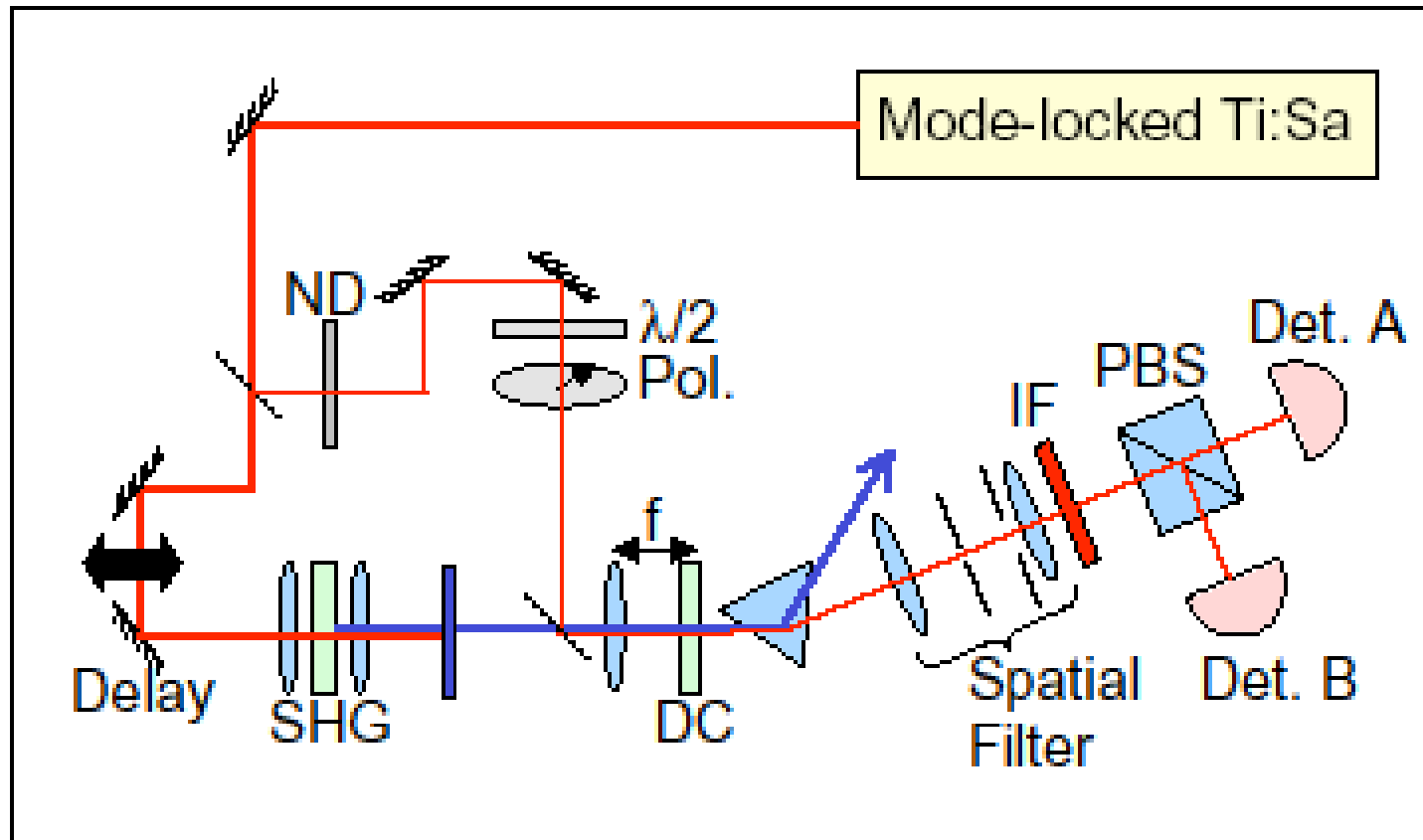

Suppression/Enhancement of Spontaneous Down-Conversion

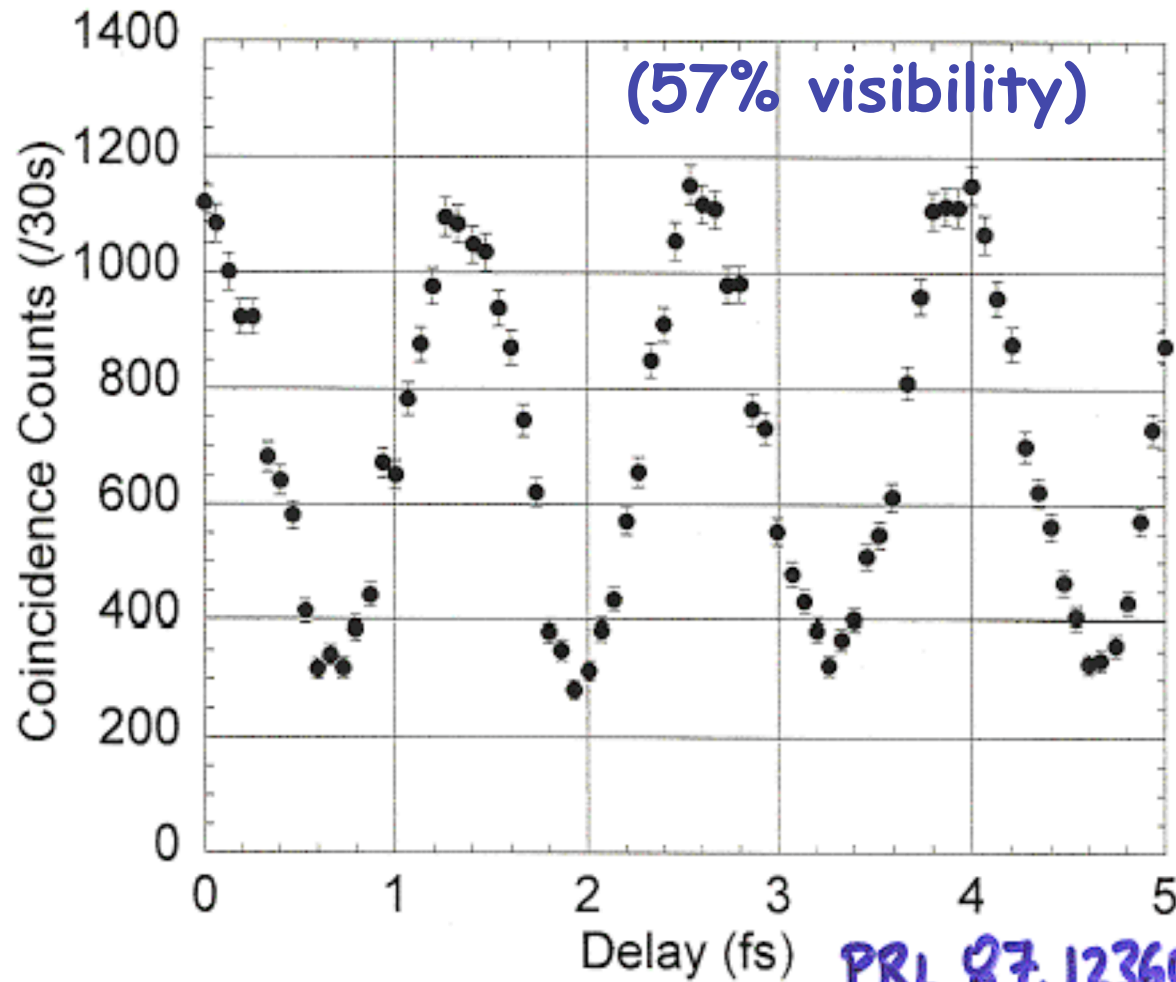

PRL 87, 123603 ('01)

Operation as a “switch”

- Phase chosen so that coincidences are eliminated

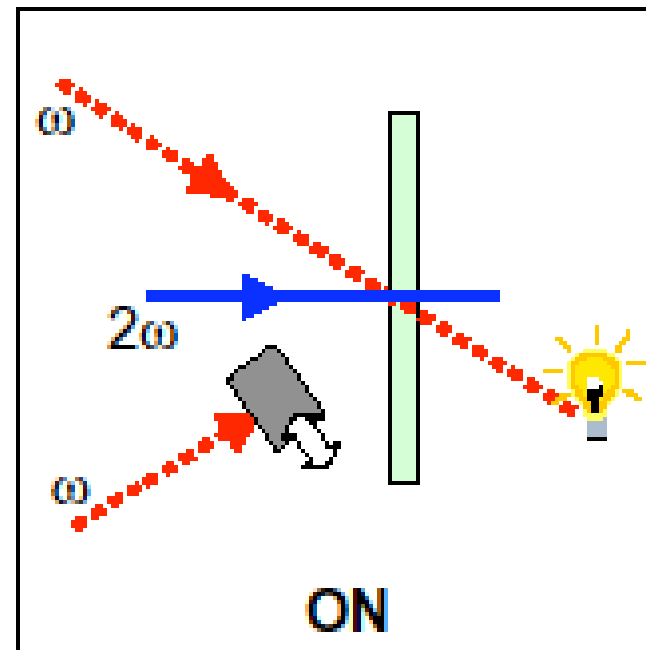
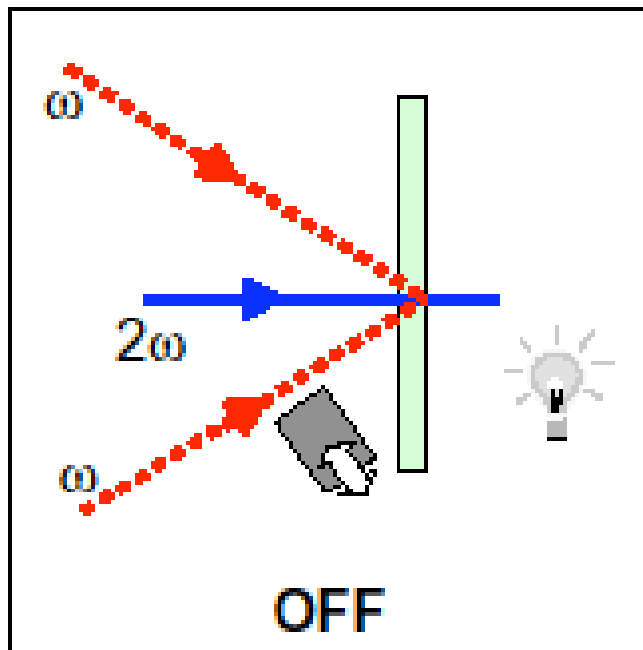

How to build a quantum computer?

Photons don't interact

(good for transmission; bad for computation)

Try: atoms, ions, molecules, ...

or just be clever with photons!

Nonlinear optics: photon-photon interactions

Generally exceedingly weak.

Potential solutions:

Cavity QED

Better materials (10^{10} times better?!)

Measurement as nonlinearity (KLM-LOQC, cluster, QND)

Novel effects (slow light, EIT, etc)

Photon-exchange effects (à la Franson)

Interferometrically-enhanced nonlinearity

Measurement as a tool: KLM...

INPUT STATE

$$a|0\rangle + b|1\rangle + c|2\rangle$$

OUTPUT STATE

$$a|0\rangle + b|1\rangle - c|2\rangle$$

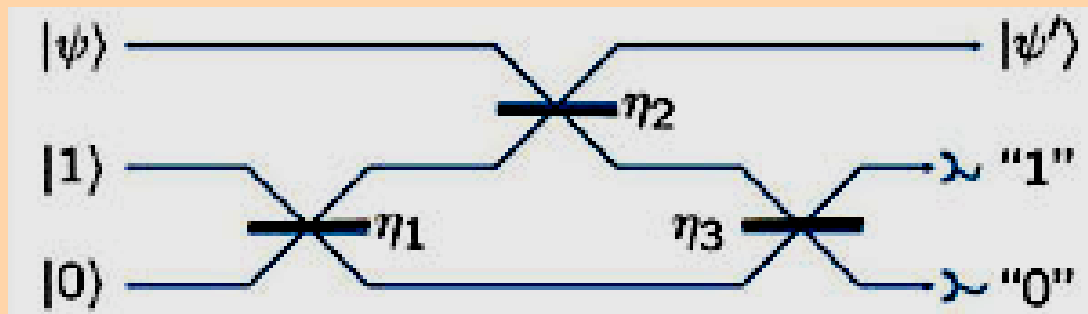

Not so surprising – recall that a beam-splitter acts as a “Bell-state filter”; whatever you send it, you get an entangled state out. *But: you had to postselect on coincidences to do it.*

Knill, Laflamme, Milburn Nature 409, 46, (2001); and others after.

Why postselection?

Of course, if each gate only “succeeds” some fraction p of the time...
the odds of an N -gate computer working scale as p^N .

Exponential cost cancels exponential gain in quantum computing.

But, clever observation: gates “commute” with teleportation.

Gottesmann & Chuang, Nature 402, 390 (1999)

Perform the gates *first*, on “blank” registers (photons from entangled pairs, which in some sense could be in any state at all), and save up the gates that worked [linear cost!]. Only now teleport the input qubits into the already-successful gates!

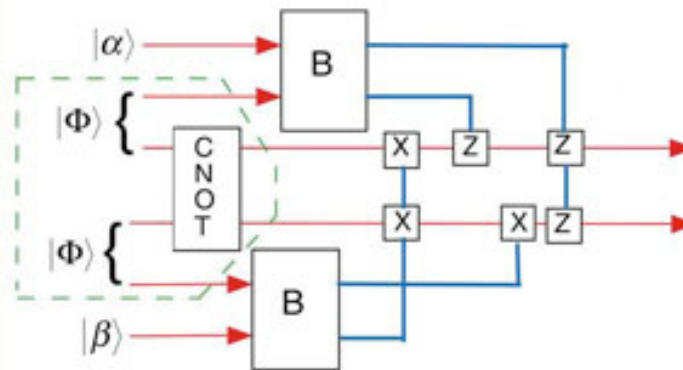

A quantum-interference controlled-phase gate

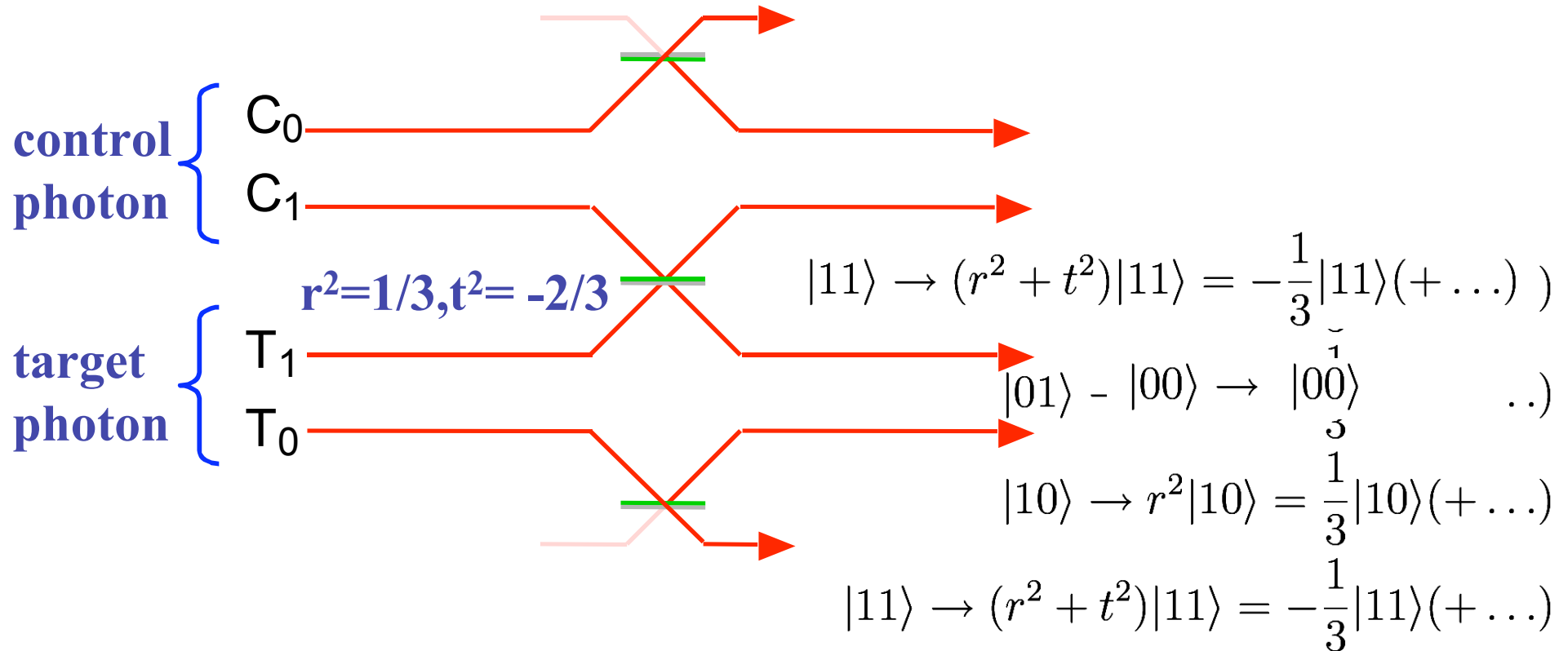

Theory: Ralph, Langford, Bell & White, *PRA* 65, 062324 (2002)

Experiment: O'Brien, Pryde, White, Ralph, & Branning, *Nature* 426, 264 (2003)

See other early experiments: Gasparoni et al., PRL 93, 020504 (2004); Pittman et al., PRA 68, 032316 (2004).

Other early theory includes Ralph *et al.* 65, 012314 (01); Pittman *et al.*, PRL 88, 257902 (02); etc.

A far more robust version

- do all the interference in polarization;
no alignment to worry about.

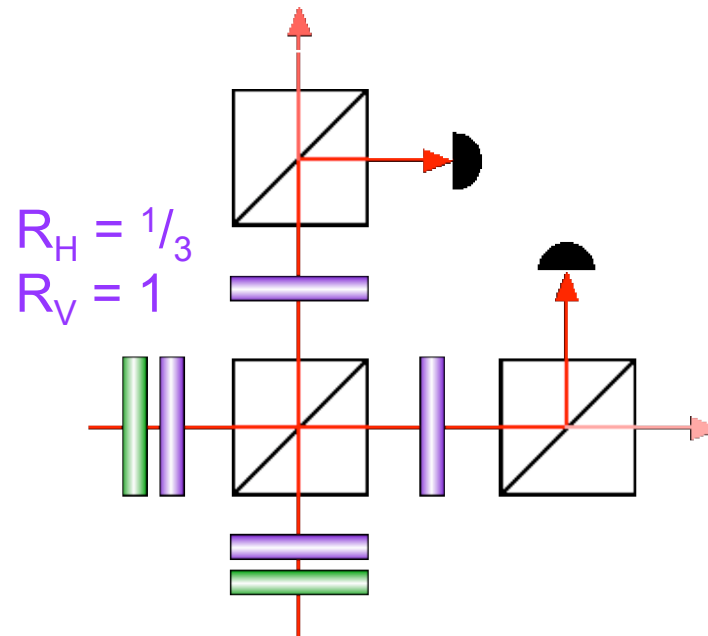

Langford *et al.* , PRL 95, 210504 (2005)

Cluster-state QC is a parallel approach utilizing the power of measurement (as is the QND approach of Munro, Nemoto, *et al.*)

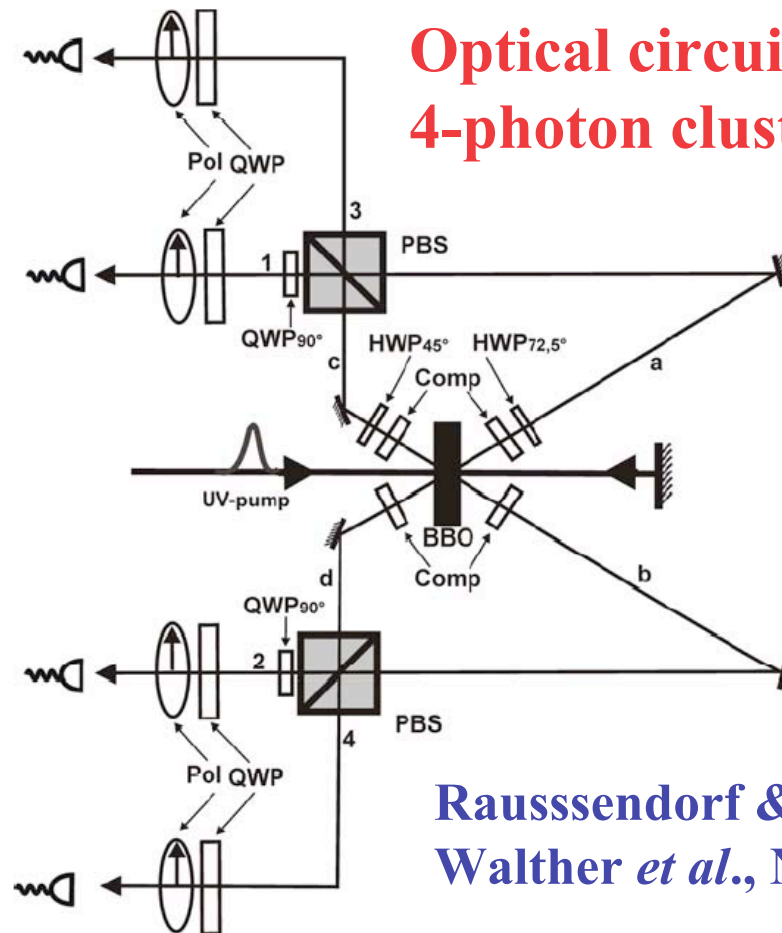

Optical circuit for generation of a 4-photon cluster state.

Raussendorf & Briegel, PRL 86, 5188 (01)
Walther *et al.*, Nature 434, 169 (05)

“Amplifying” *weak(-ish)* nonlinearities by using them to make measurements, which in turn lead to gates: Nemoto & Munro, PRL 93, 250502 (04)

Highly number-entangled states ("low-noon" experiment).



M.W. Mitchell *et al.*, Nature **429**, 161 (2004)

States such as $|n,0\rangle + |0,n\rangle$ ("noon" states) have been proposed for high-resolution interferometry – related to "spin-squeezed" states.

Important factorisation:

$$(a^{\dagger 3} + b^{\dagger 3}) = (a^{\dagger} + b^{\dagger}) (a^{\dagger} + e^{2\pi i/3} b^{\dagger}) (a^{\dagger} + e^{-2\pi i/3} b^{\dagger})$$

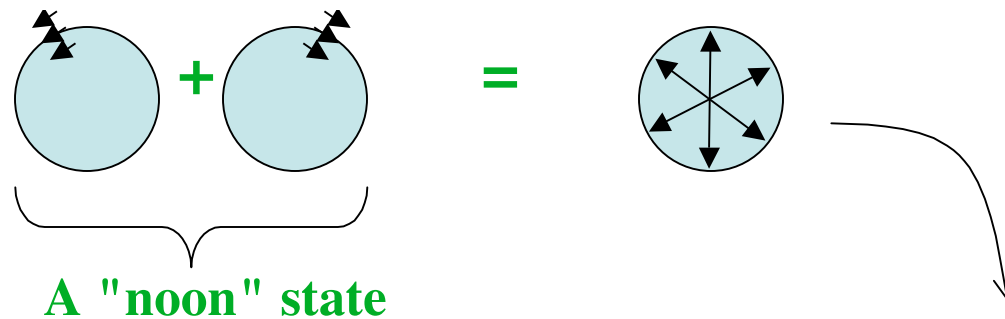

A really odd beast: one 0° photon, one 120° photon, and one 240° photon... but of course, you can't tell them apart, let alone combine them into one mode!

Theory: H. Lee *et al.*, Phys. Rev. A **65**, 030101 (2002); J. Fiurásek, Phys. Rev. A **65**, 053818 (2002)

How does this get entangled?

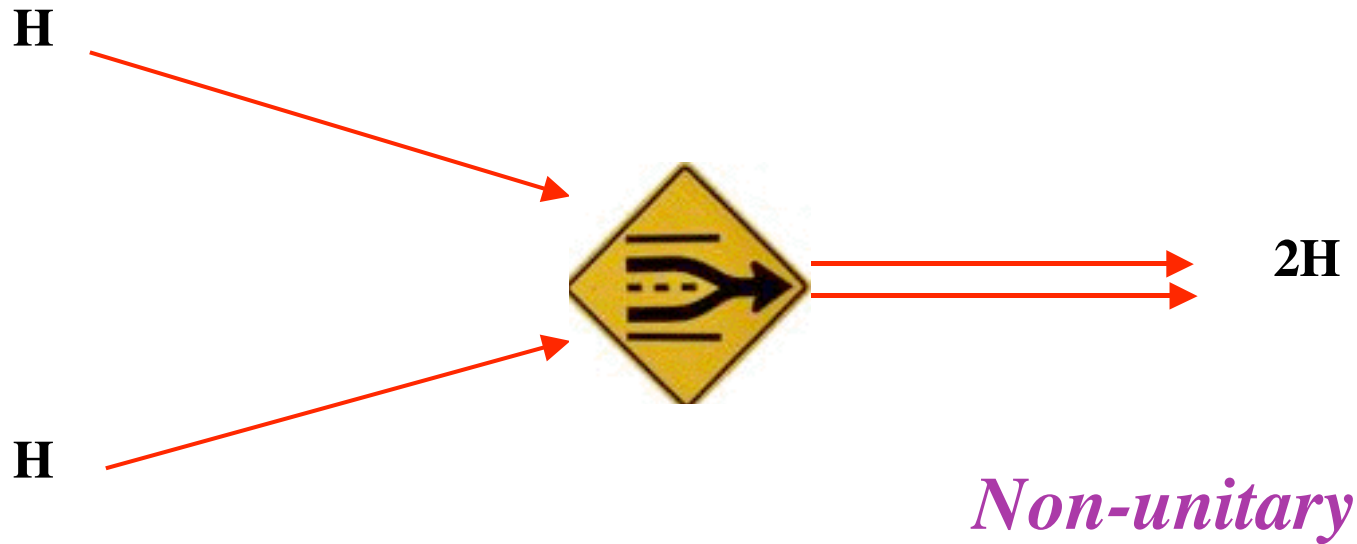

How does this get entangled?

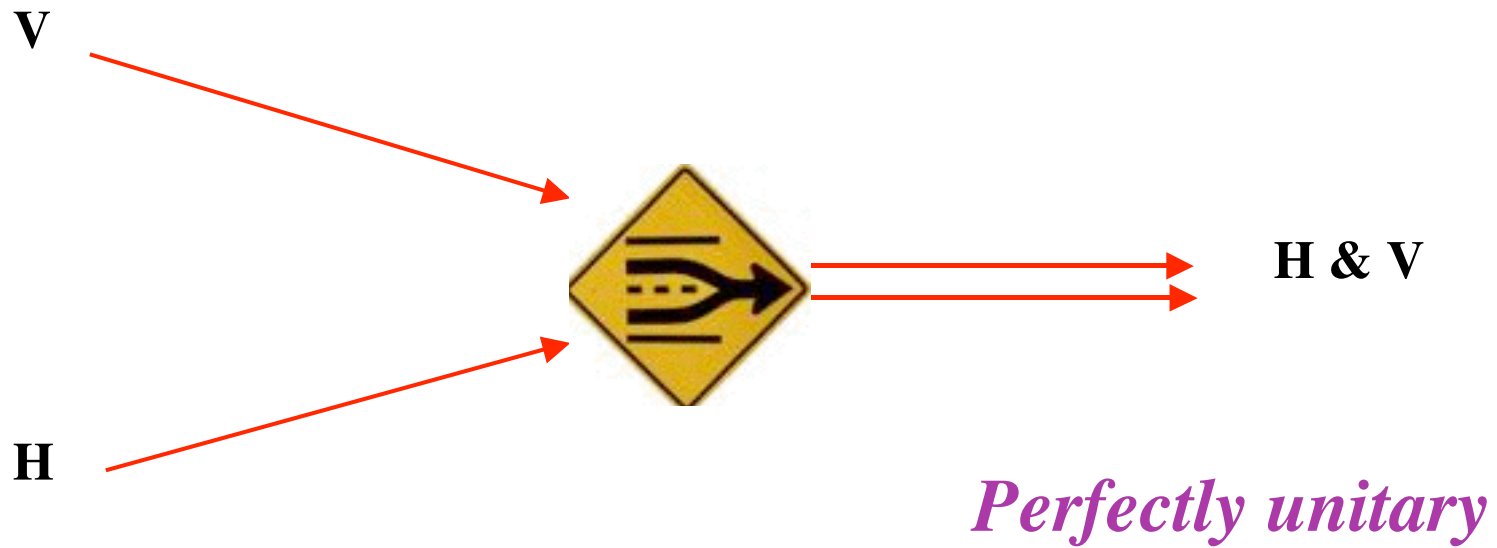

How does this get entangled?

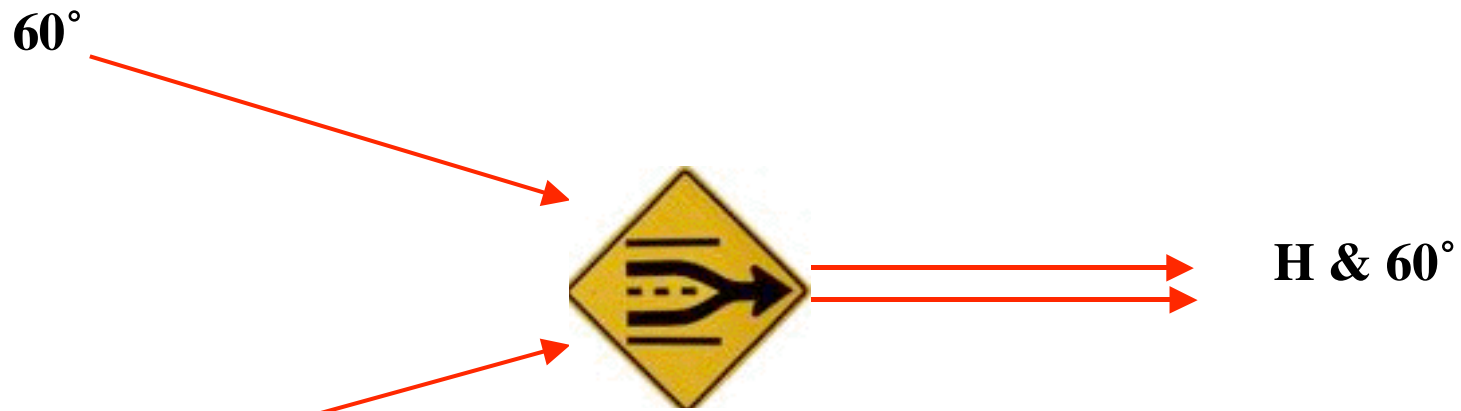

Non-unitary

*(Initial states orthogonal
due to spatial mode; final
states non-orthogonal.)*

Trick #1

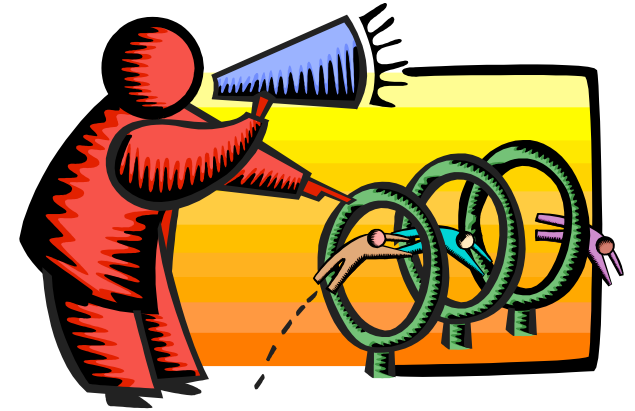

How to combine three non-orthogonal photons into one spatial mode?

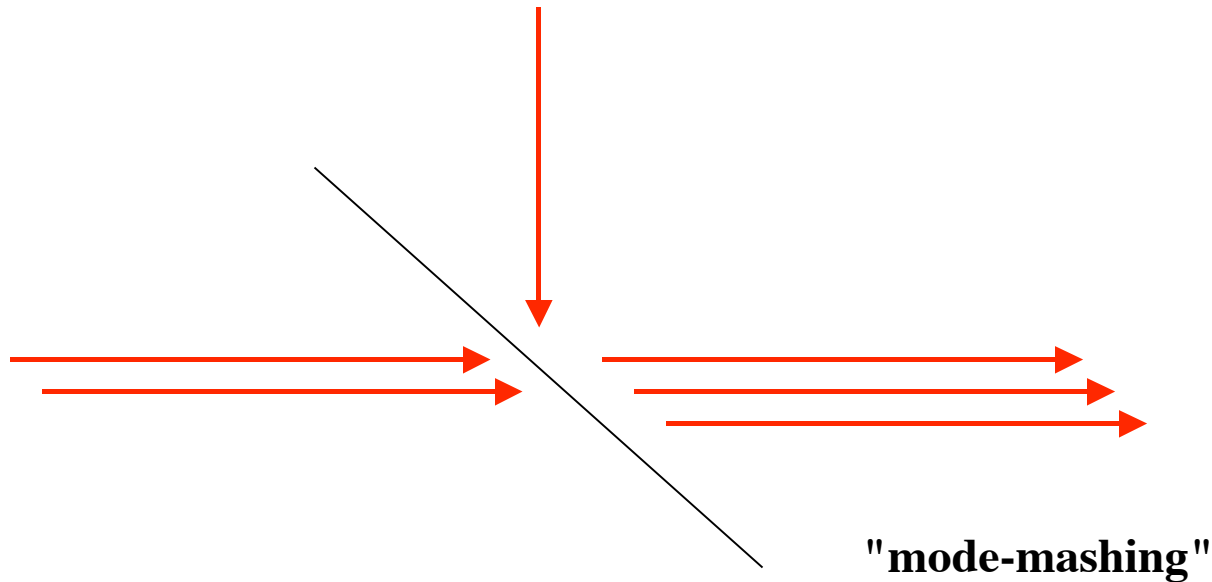

Yes, it's that easy! If you see three photons out one port, then they all went out that port.

 Post-selective nonlinearity

But do you really *need* non-unitarity?

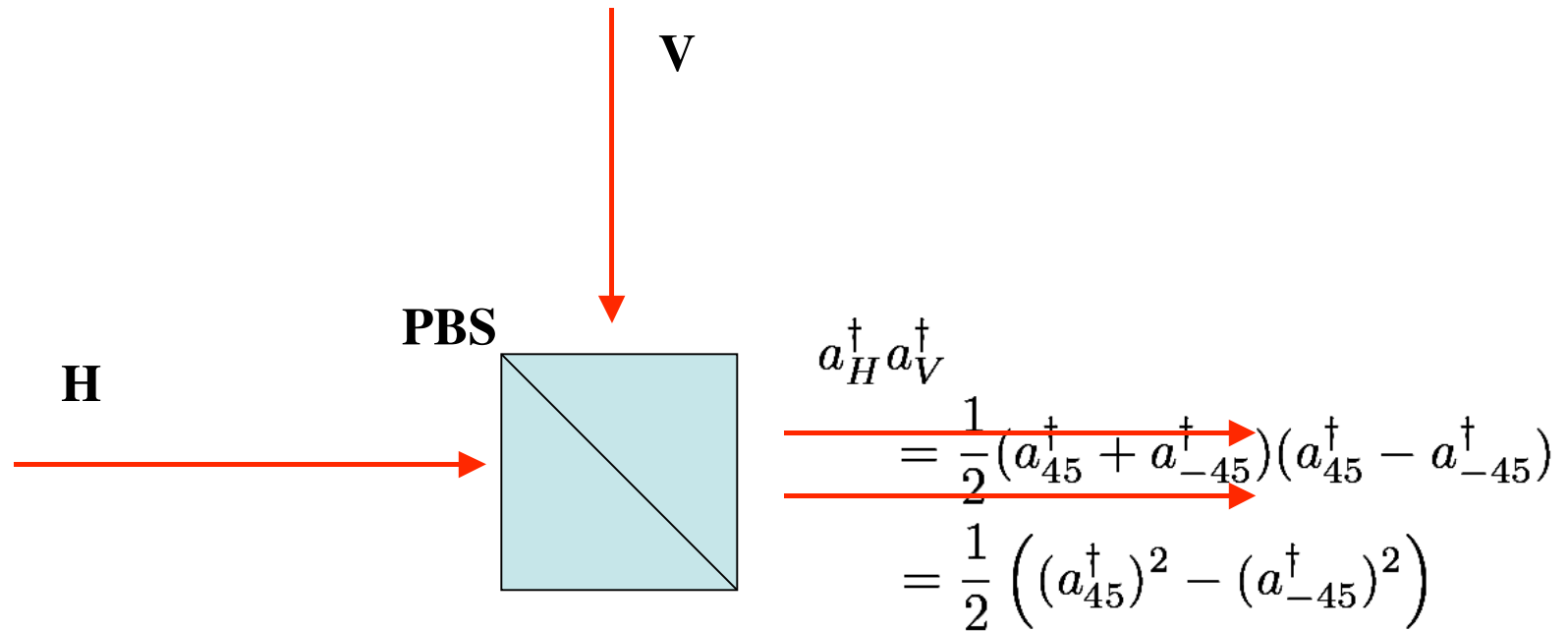

Has this unitary, linear-optics, operation entangled the photons?

- Is $|HV\rangle = |+\rangle|+\rangle - |-\rangle|-\rangle$ an entangled state of two photons at all, or “merely” an entangled state of two field modes?
- Can the two indistinguishable photons be considered individual systems?
- To the extent that they can, does bosonic symmetrization mean that they were always entangled to begin with?

Is there any qualitative difference in the case of $N > 2$ photons?

Where does the weirdness come from?

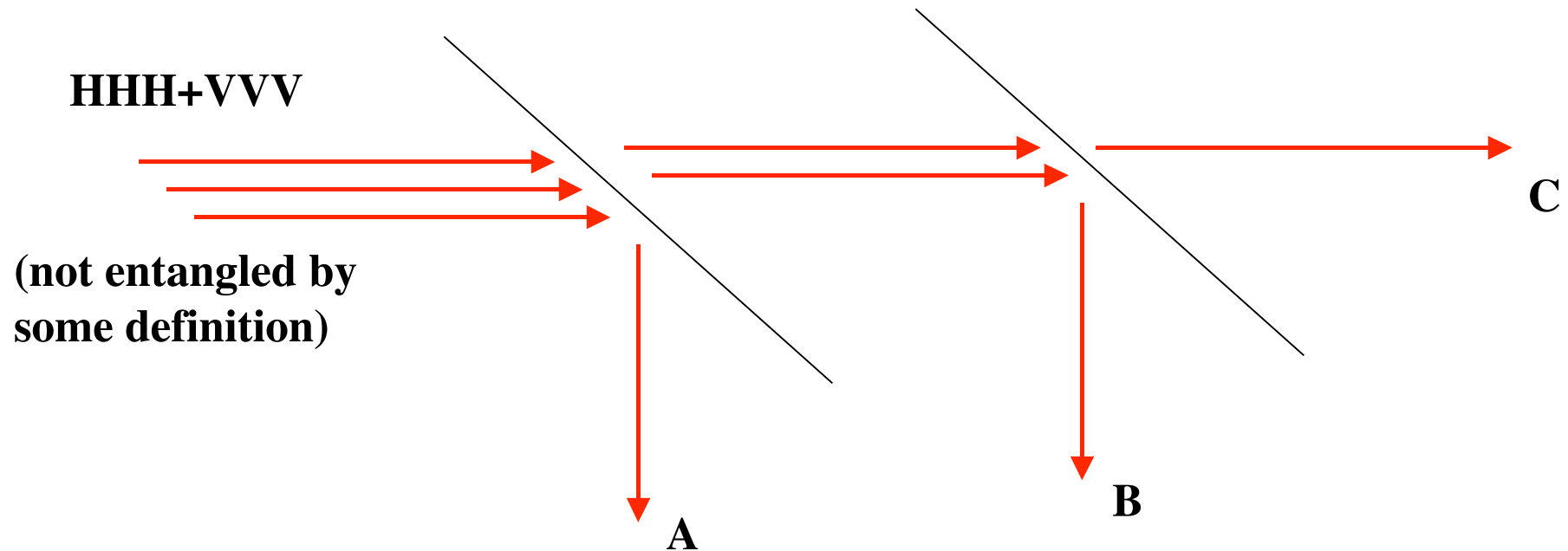

If a photon winds up in each of modes {A,B,C}, then the three resulting photons are in a GHZ state – 3 clearly entangled subsystems.

You may claim that no entanglement was created by the BS's and post-selection which created the 3003 state... but then must admit that some is created by the BS's & postselection which split it apart.

Trick #2



Okay, we don't even have single-photon sources*.

But we can produce *pairs* of photons in down-conversion, and very *weak* coherent states from a laser, such that *if* we detect three photons, we can be pretty sure we got only one from the laser and only two from the down-conversion...

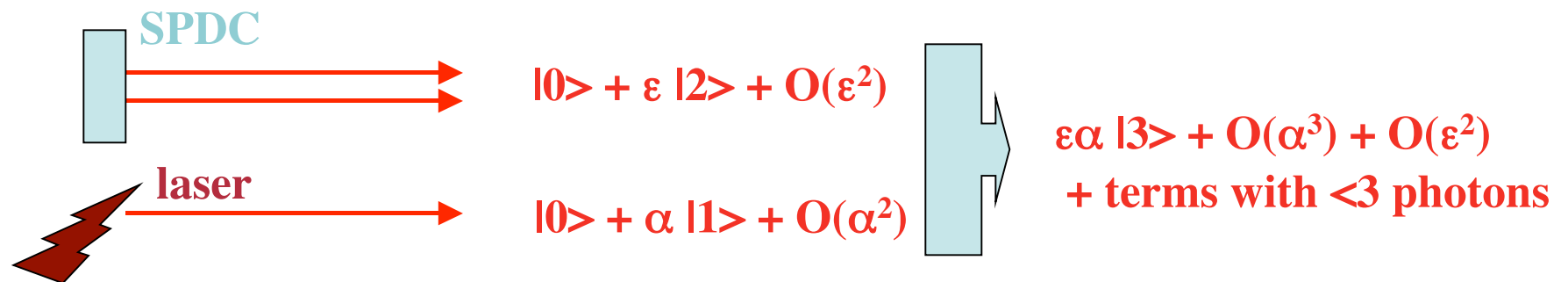

* But we're working on it (collab. with Rich Mirin's quantum-dot group at NIST)

Trick #3

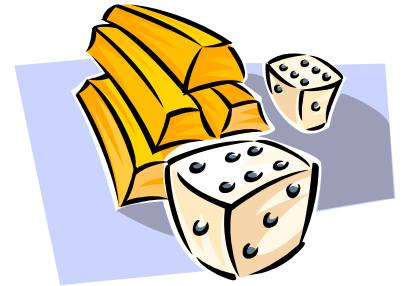

But how do you get the two down-converted photons to be at 120° to each other?

More post-selected (non-unitary) operations: if a 45° photon gets through a polarizer, it's no longer at 45° . If it gets through a *partial* polarizer, it could be anywhere...

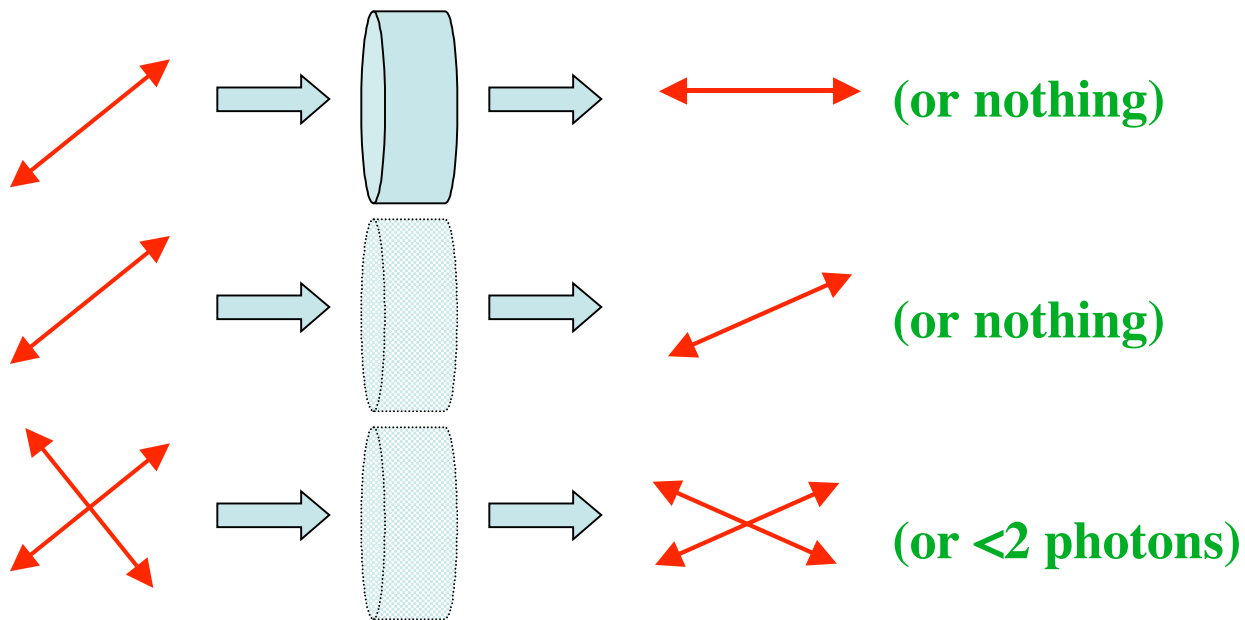

The basic optical scheme

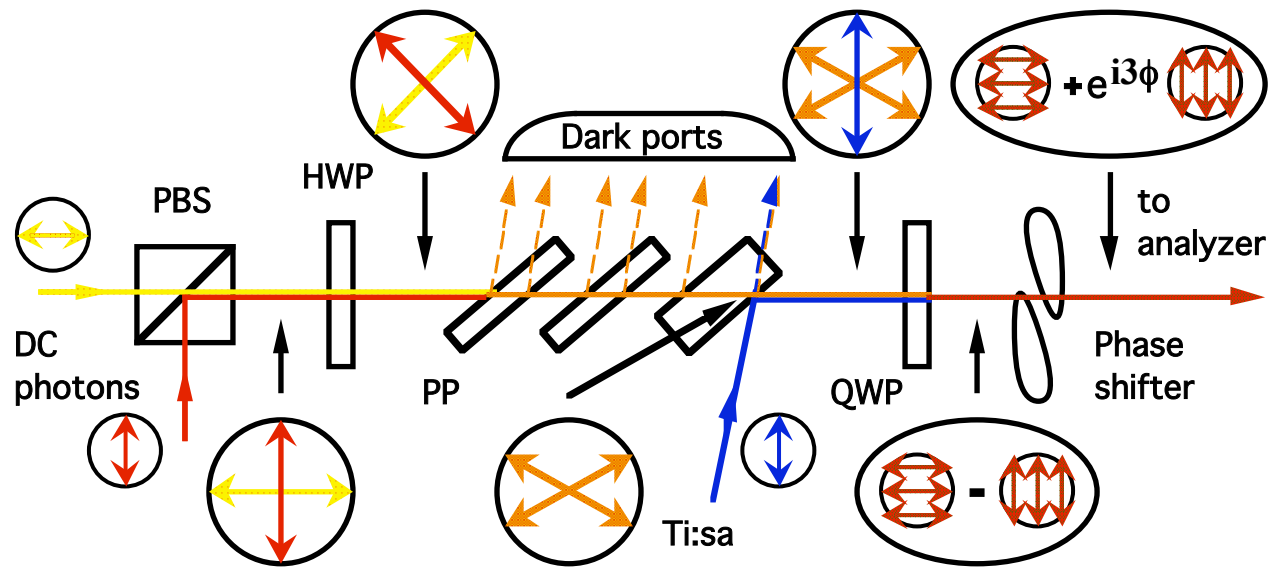

More detailed schematic of experiment

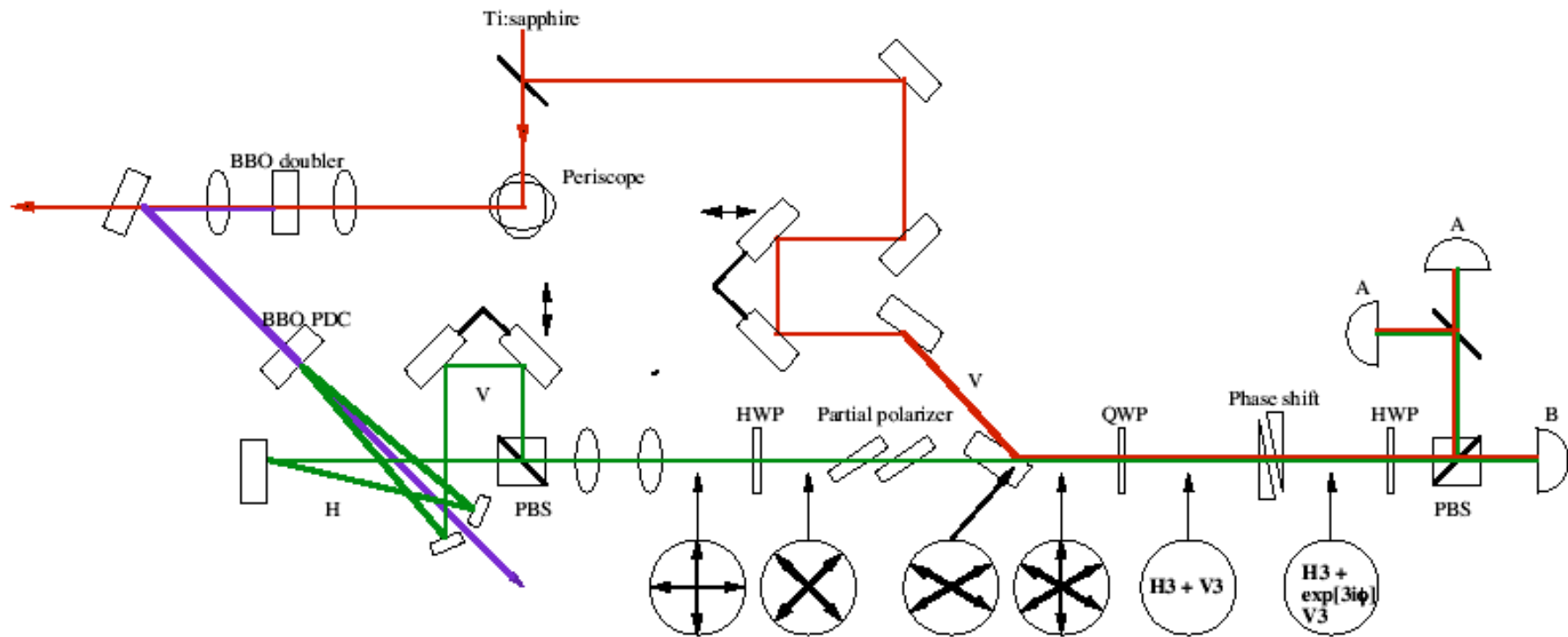

It works!



Singles:

Coincidences:

Triple
coincidences:

Triples (bg
subtracted):

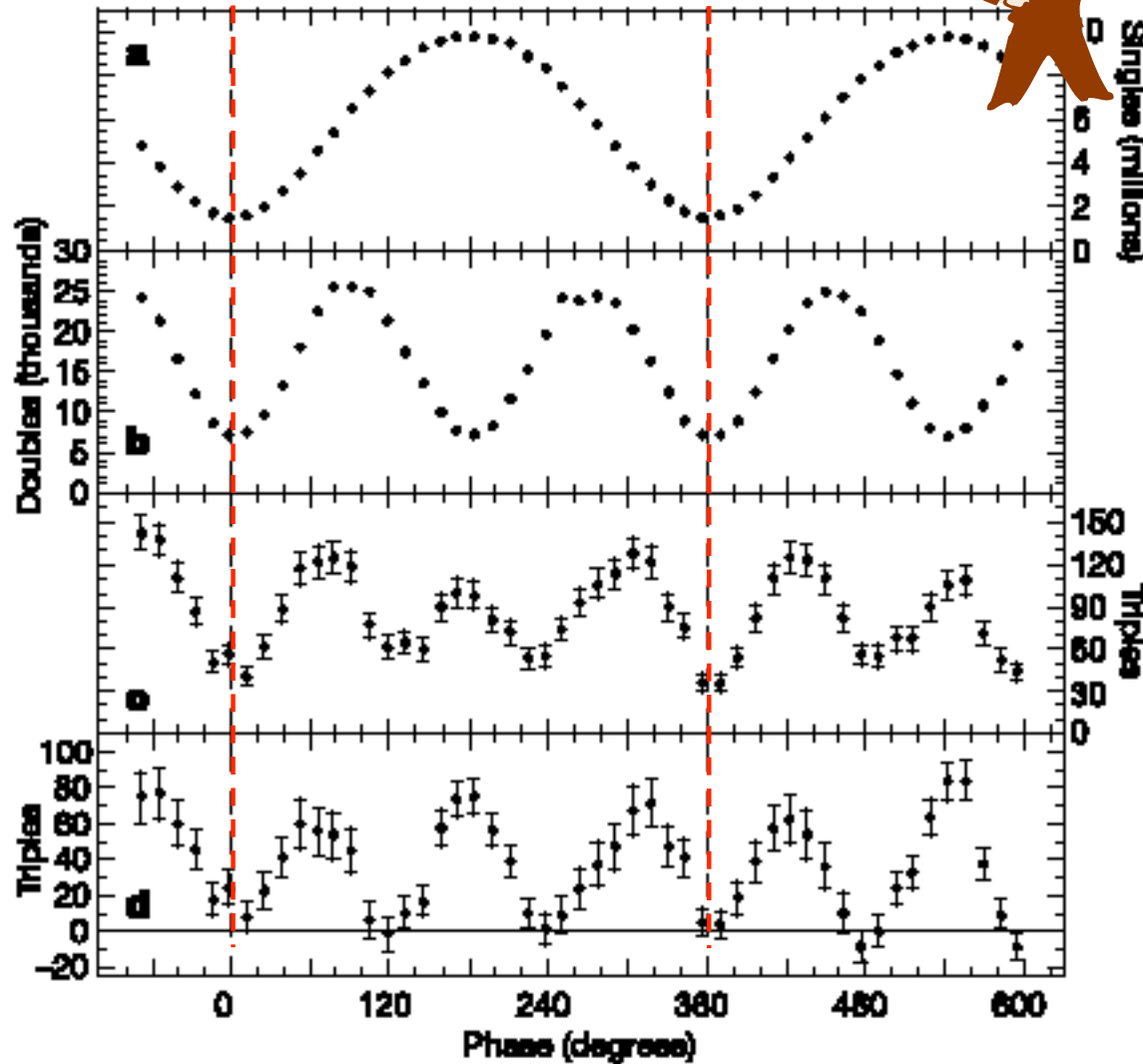

M.W. Mitchell, J.S. Lundeen, and A.M. Steinberg, Nature 429, 161 (2004)

Hot off the presses (well, actually, not on them yet):

Density matrix of the triphoton

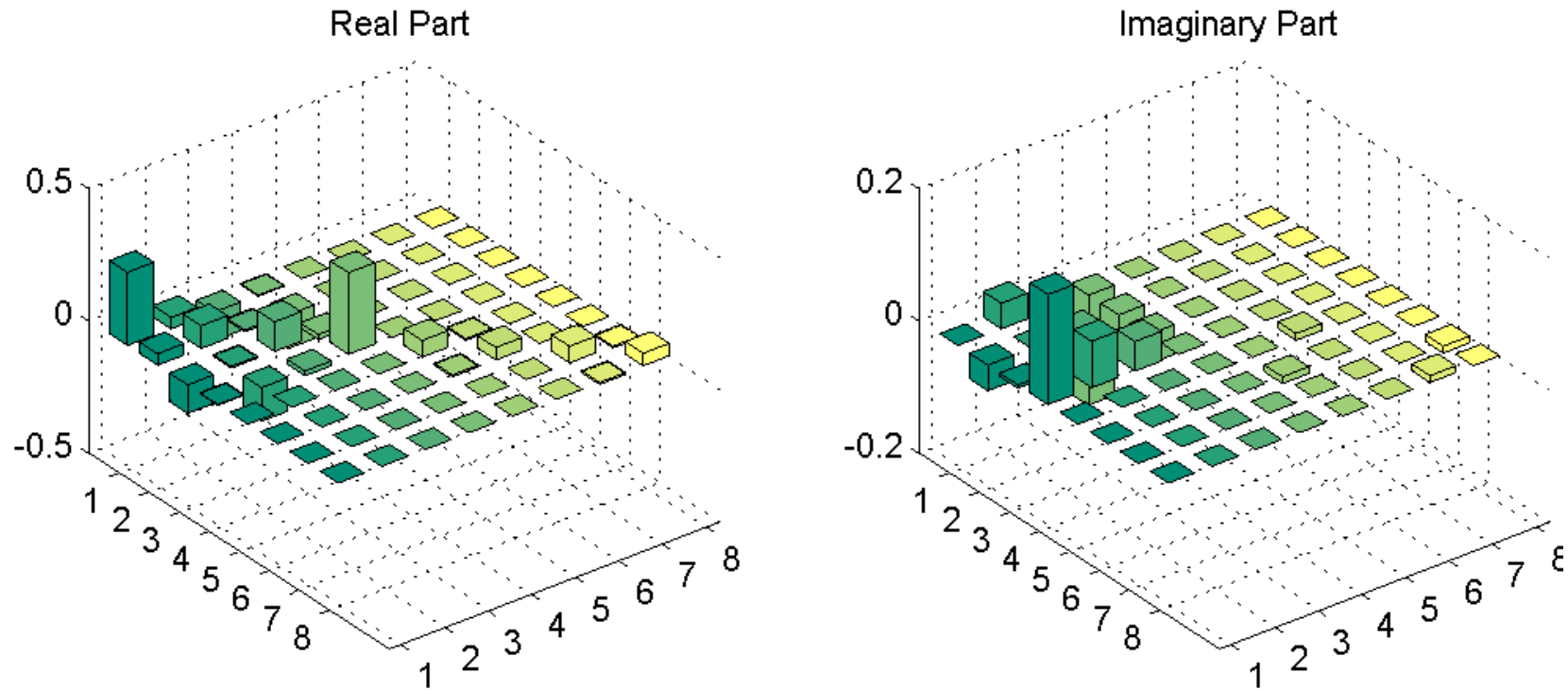

(80% of population in symmetric subspace)

Extension to n-particle systems: R.B.A. Adamson, P.S. Turner, M.W. Mitchell, AMS, sub. to PRA

Coherent State

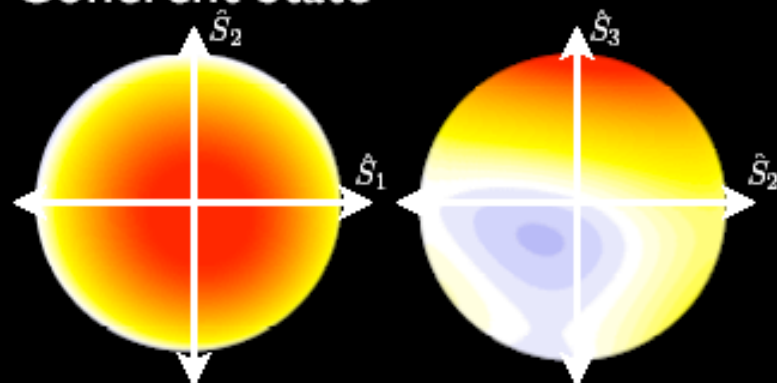

$$|3, 0\rangle_{R,L}$$

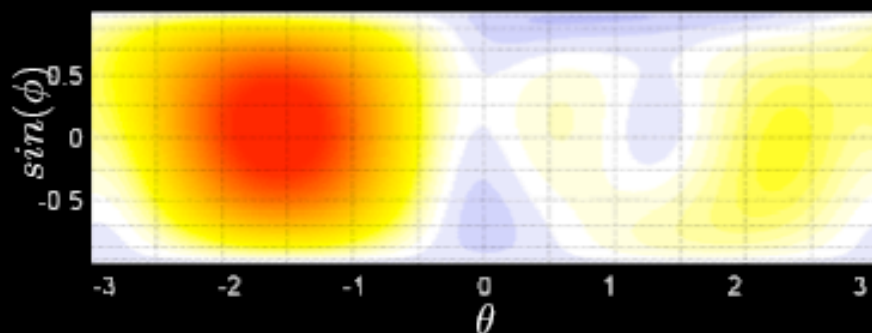

Phase State

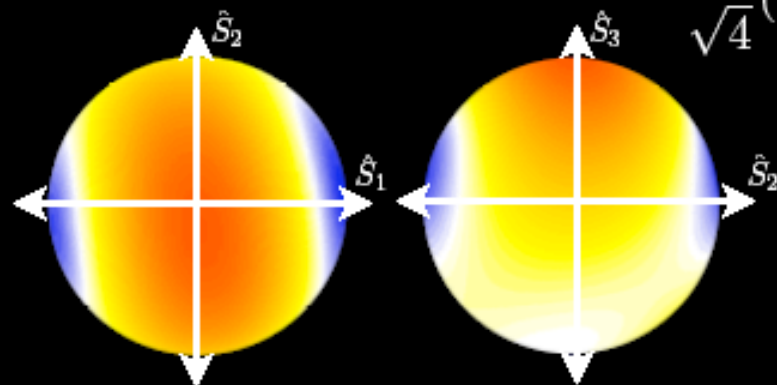

$$\frac{1}{\sqrt{4}}(|3, 0\rangle_{H,V} + |2, 1\rangle_{H,V} + |1, 2\rangle_{H,V} + |0, 3\rangle_{H,V})$$

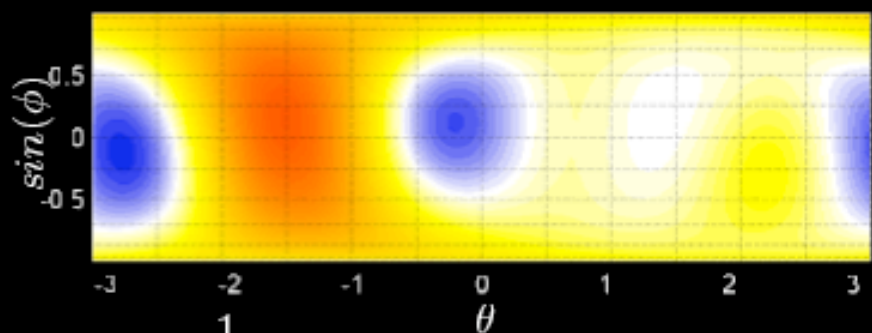

N00N State

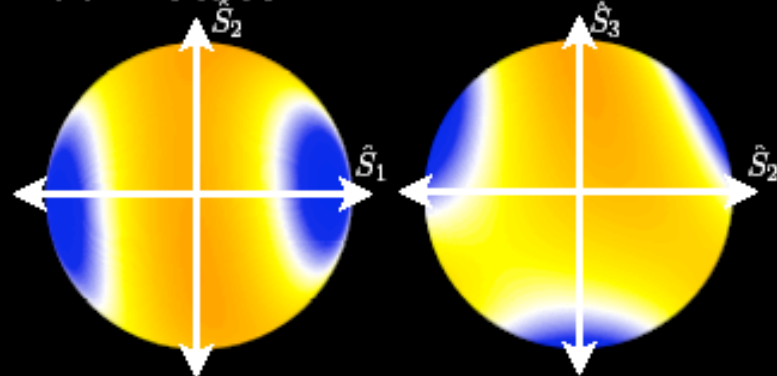

$$\frac{1}{\sqrt{2}}(|3, 0\rangle_{H,V} + |0, 3\rangle_{H,V})$$

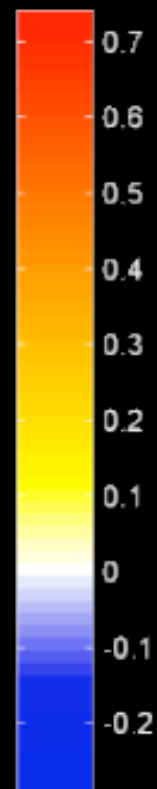
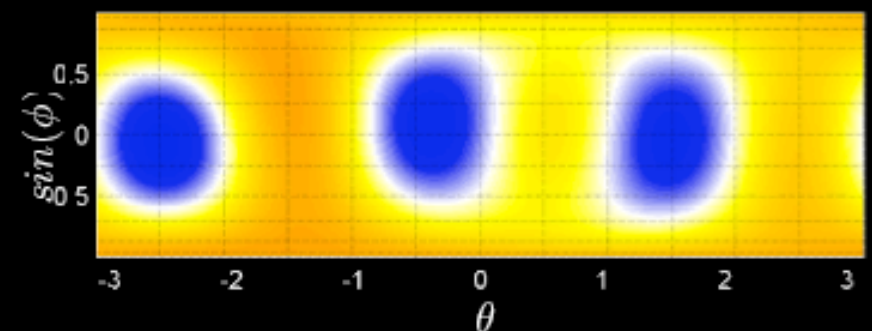

Summary & References

Photons are not so complicated, but not so simple either.

Feynman paths interfere, whenever they lead to the same final state of the universe.

Collapse is a *useful* (but not necessary) picture.

Quantum interference offers a rich array of phenomena useful for QI.

Measurement (postselection) can be a very powerful tool.

SOME REFERENCES:

(The obvious textbooks – Nielsen & Chuang; Loudon; Walls & Milburn; etc...)

Gerry & Knight: *Introductory Quantum Optics* (Cambr. Univ. Press 2004)

QO review: Steinberg, Chiao, Kwiat, in *AIP AMO Physics Handbook*, edited by
G.W.F. Drake (http://www.physics.utoronto.ca/~steinber/Quantum_Optical.pdf).

QO for QI review: Pan, Chen, Zukowski, Weinfurter, Zeilinger, arXiv:0805.2853
(and many references therein)

More links available at <http://www.physics.utoronto.ca/~aephraim/aephraim.html>
as well.