



Tubes Radiogènes à Anode Tournante  
 Röntgenröhre mit rotierender Anode  
 Tubos de Rayos-X con Ánodo Giratorio

Note: Document originally drafted in the English language.

<b>Product Description</b>	<b>Description du Produit</b>	<b>Produktbeschreibung</b>	<b>Descripcion del Producto</b>
<p>The G-1087 is a 4.25" (108 mm) 150 kV, 740 kJ (1.0 MHU) maximum anode heat content, rotating anode insert. This metal center section insert is designed for radiography, cineradiography, digital and film screen angiography procedures. The insert features a 12° rhenium-tungsten facing on molybdenum with a graphite backed target and is available with the following nominal focal spots:</p> <p style="text-align: center;">0.3 - 1.2 IEC 60336</p> <p><b>Reference Axis:</b> Perpendicular to port face.</p> <p><b>Nominal Anode Input Power</b> Small - 12 kW IEC 60613 Large - 100 kW IEC 60613 For the equivalent anode input power of 235 Watts</p> <p>G-1087 models have grid control capability.</p> <p>Grid Control Voltages: Typical Bias Voltage for Cutoff at 150 kV ..... -3700Vdc Grid Voltage for Exposure ... 0 Vdc</p>	<p>Le tube G-1087, à anode tournante de 108 mm, (4,25 pouces), 150 kV, avec une capacité calorifique maximale de 740 kJ (1,0 MUC). Cette section métallique centrale a été conçue pour les procédures radiographiques, cinéradiographiques, et angiographiques numérisés et sur film. L'tube est pourvu d'une anode avec pente de 12° en rhénium - tungstène sur une base de molybdène et avec un doublage de graphite. Il est disponible avec les foyers suivantes:</p> <p style="text-align: center;">0,3 - 1,2 CEI 60336</p> <p><b>Référence Axe:</b> Perpendiculaire à la face de sortie.</p> <p><b>Puissance anodique nominale de l'anode</b> Petit foyer - 12 kW CEI 60613 Grand foyer - 100 kW CEI 60613 Pour la puissance anodique d'équilibre thermique de 235 Watts</p> <p>Les Modèles G-1087 ont une fonction de commande de grille.</p> <p>Potentiel de controle de grille: Voltage typique pour coupure et 150 kV ..... -3700 Vcc Voltage de grille pendant exposition ..... 0 Vcc</p>	<p>Die G-1087 ist eine 4.25" (108 mm) Doppelfokus Drehanoden-Röntgenröhre, mit einer Anoden Wärmespeicherkapazität von 740 kJ (1.0 MHU) und einer max. Spannungsfestigkeit von 150 kV. Diese Einsatz mit metallischem Mittelteil wurde für Radiographie-, Röntgenkinematographie-, digitale und Filmangiographieverfahren entwickelt. Der rückseitig graphitbeschichtete Rhenium-Wolfram- und Molybdän Anodenteller besitzt einen Winkel von 12°. Folgende Brennfleckkombination ist lieferbar:</p> <p style="text-align: center;">0.3 - 1.2 IEC 60336</p> <p><b>Referenz Axes:</b> Senkrecht zum strahlenaustrittsfenster.</p> <p><b>Nominale Anodenbezugsleistung</b> Klein - 12 kW IEC 60613 Gross - 100 kW IEC 60613 Gilt bei einer Aquivalent - Anodenleistung von 235 Watt</p> <p>Modell G-1087 ist mit Gittersteuerungsfunktion ausgestattet.</p> <p>Gittersteuerspannungen: Typische Vorspannung für Abschaltung bei 150 kV ..... -3700Vdc Gitterspannung für Belichtung .. 0 Vdc</p>	<p>El G-1087 es un tubo de ánodo giratorio de 108 mm (4.25"), 150 kV, 740 kJ (1.0 MUC). Este tubo de metal en la parte central es diseñado específicamente para radiografía, cineradiográfica, digital, y procedimientos de angiografía con película de pantalla. El blanco emisor es una combinación de renio, tungsteno y molibdeno con grafito en la parte posterior con un rayo central de 12 grados. Disponible con las siguientes combinaciones de marcas focales:</p> <p style="text-align: center;">0.3 - 1.2 IEC 60336</p> <p><b>Referencia de Axes:</b> Perpendicular a la abertura facial.</p> <p><b>Potencia nominal de entrada del anodo</b> Foco fine - 12 kW IEC 60613 Foco grueso - 100 kW IEC 60613 Para una potencia equivalente del anodo de 235 W</p> <p>El modelo G-1087 tiene capacidad para de rejillas controlar los electrones.</p> <p>Voltaje de Rejillas Controlada: Voltaje controlado típico con interruptor a 150 kV ..... -3700 Vdc Voltaje de rejillas con exponición .....0 Vdc</p>

Manufactured by Varian Medical Systems  
Fabrique par Varian Medical Systems  
Hergestellt von Varian Medical Systems  
Fabricado por Varian Medical Systems

Specifications subject to change without notice.  
Spécifications susceptibles d'être modifiées sans préavis.  
Technische Daten ohne Gewähr.  
Especificaciones sujetas a cambio sin previo aviso.

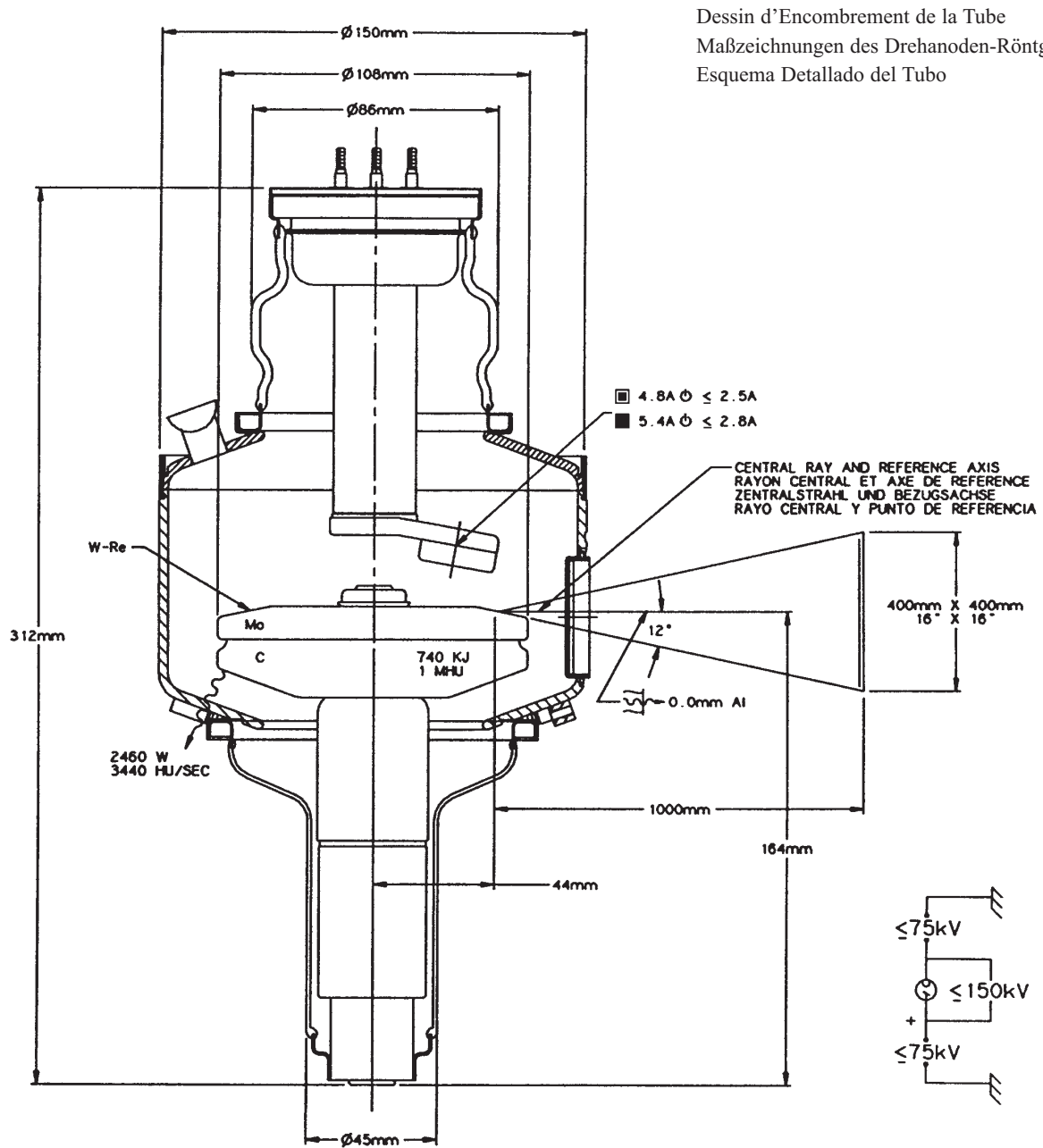

Dessin d'Encombrement de la Tube  
 Maßzeichnungen des Drehanoden-Röntgenröhre  
 Esquema Detallado del Tubo

Large - Black  
 Grand - Noir  
 Gross - Schwarz  
 Largo - Negro

Small - White  
 Petit - Blanc  
 Klein - Weiss  
 Pequeño - Blanco

Stand-By  
 Attente  
 Bereitschaft  
 En Espera

Frame or Chasis  
 Masse  
 Chassis  
 Soporte o Chasis

X-Ray Tube  
 Tube Radiogène  
 Röntgenröhre  
 Tubo de Rayos X

Radiation Filter or Filtration  
 Filtre de rayonnement  
 Filterung  
 Filtración de Radiación

**3 Ø FULL WAVE**

Abaques d'Émissions des Filaments CEI 60613  
Heizfadenemissionsdiagramm IEC 60613  
Curvas de Emisión de los Filamentos IEC 60613

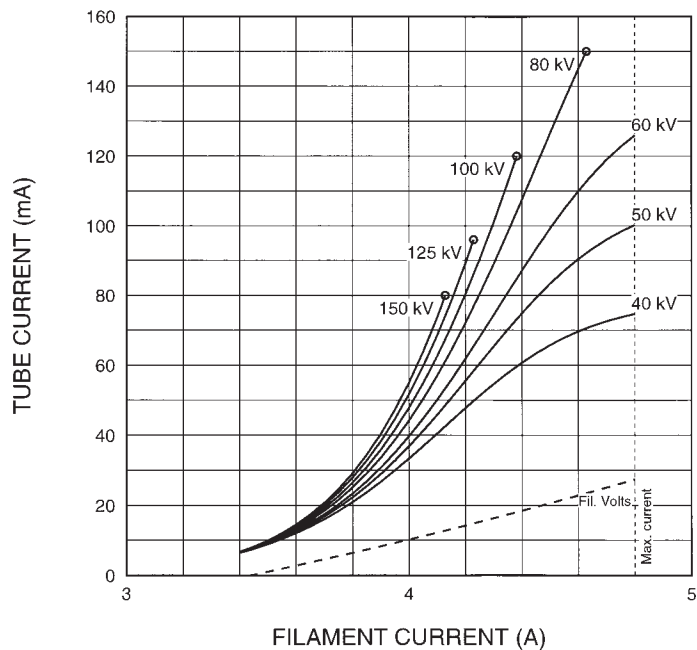

THREE PHASE EMISSION (± .15 A)

G-1087 0.3

FILAMENT VOLTAGE (V)

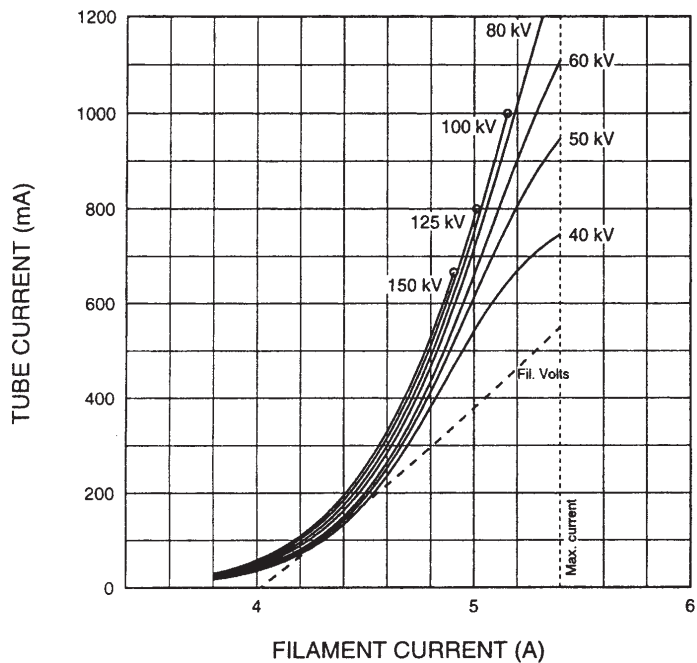

THREE PHASE EMISSION (± .15 A)

G-1087 1.2

FILAMENT VOLTAGE (V)

Note: When using these emission curves for trial exposures, refer to the power rating curves shown for maximum kV, tube emission, filament current, exposure time, and target speed.

Remarque: Lors de l'utilisation de ces abaques pour des expositions d'essai, référez-vous aux courbes maximales de kV, d'émission du filament, de temps d'exposition et de vitesse de rotation.

Anmerkung: Wenn Sie diese Emissionskurven für Testaufnahmen verwenden, beziehen Sie sich hierbei auf die entsprechenden Nennleistungskurven für max. kV-Werte, Röhrenemission, Heizstrom, und Anodendrehzahl.

Nota: Si utiliza estas curvas de emisión para exposiciones de prueba, refiérase a las curvas de gradación de potencia para el máximo de kV, tubo de emisión, corriente en los filamentos, tiempo de exposición, y a las curvas de velocidad del objetivo.

# 3 Ø Constant Potential

**50 Hz**

Abaques de Charge pour Pose Unique CEI 60613  
Brennfleck - Belastungskurven IEC 60613  
Diagramas de Exposición Radiográfica IEC 60613

## Nominal Focal Spot Size - 0.3

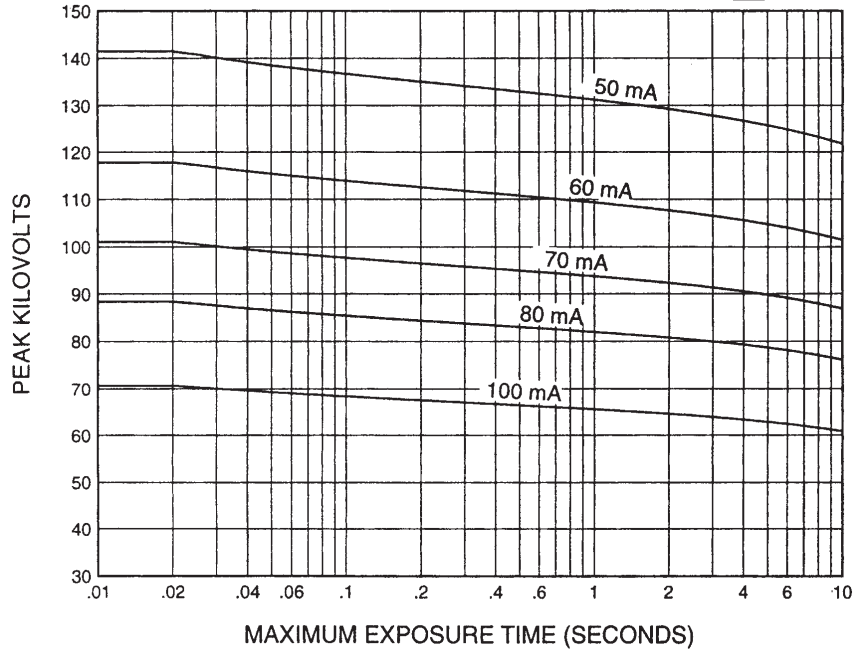

## Nominal Focal Spot Size - 1.2

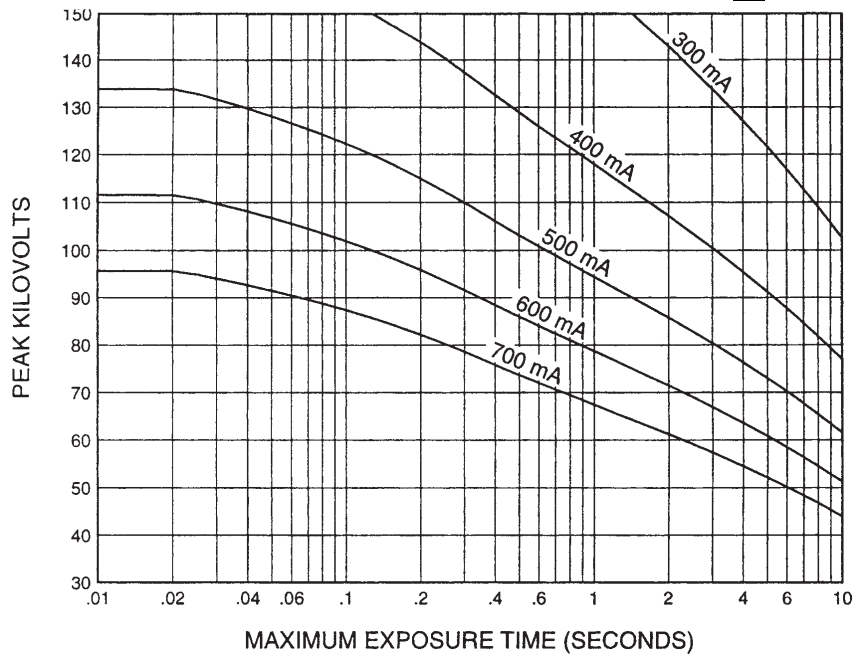

Nominal anode input power for the anode heat content 40%. IEC 60613

Puissance calorifique nominale de l'anode: 40%, CEI 60613

Thermische Anodenbezugsleistung bei einer Wärmespeicherung von 40%. IEC 60613

Aproximadamente el poder de penetracion para obtener un almacenaje de calor del anodo de 40%. IEC 60613

# 3 Ø Constant Potential

**60 Hz**

Abaques de Charge pour Pose Unique CEI 60613  
Brennfleck - Belastungskurven IEC 60613  
Diagramas de Exposición Radiográfica IEC 60613

**Nominal Focal Spot Size - 0.3** 

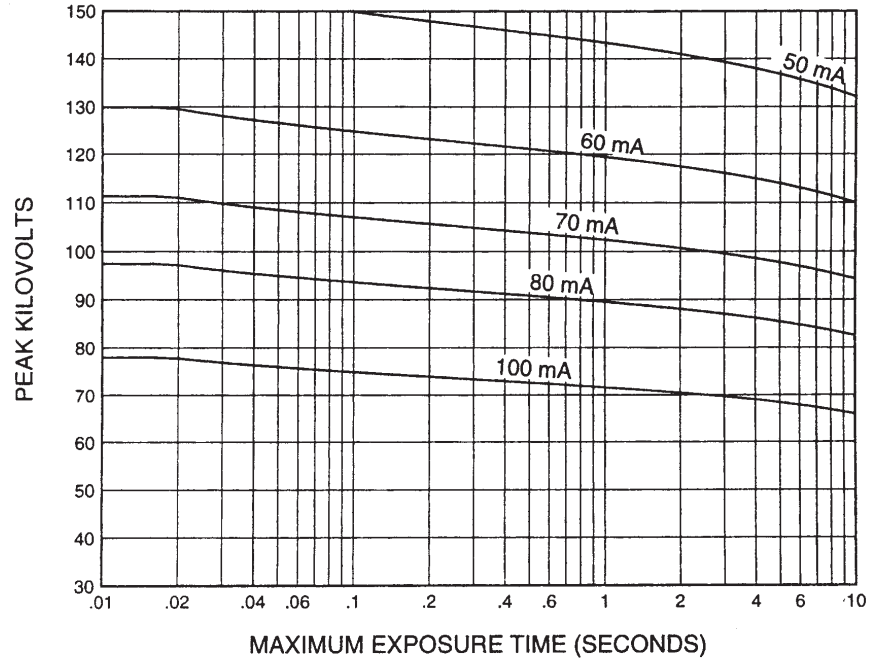

**Nominal Focal Spot Size - 1.2** 

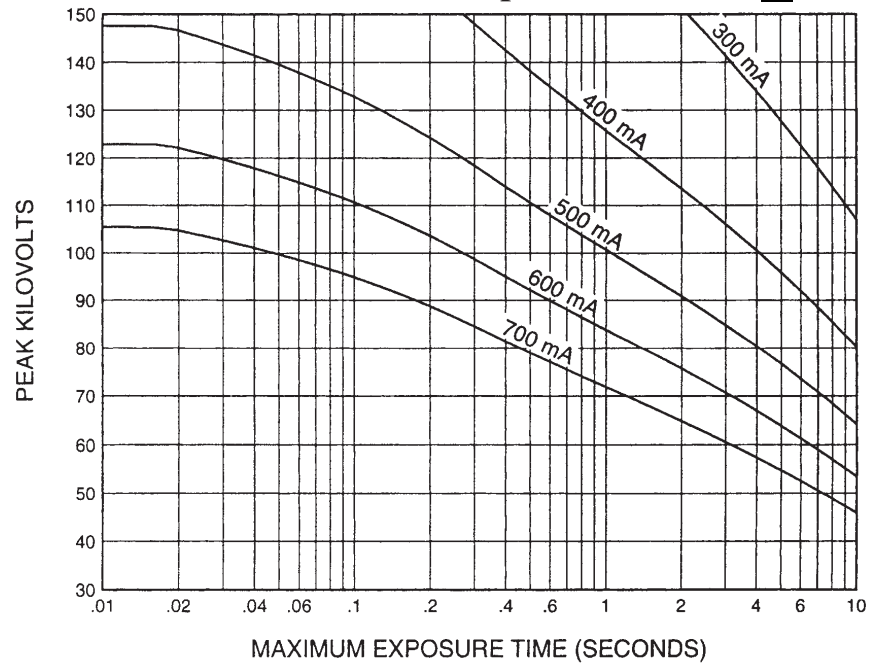

Nominal anode input power for the anode heat content 40%. IEC 60613

Puissance calorifique nominale de l'anode: 40%, CEI 60613

Thermische Anodenbezugsleistung bei einer Wärmespeicherung von 40%. IEC 60613

Aproximadamente el poder de penetracion para obtener un almacenaje de calor del anodo de 40%. IEC 60613

### 3 Ø Constant Potential

Abaques de Charge pour Pose Unique CEI 60613  
Brennfleck - Belastungskurven IEC 60613  
Diagramas de Exposición Radiográfica IEC 60613

**150 Hz**

#### Nominal Focal Spot Size - 0.3

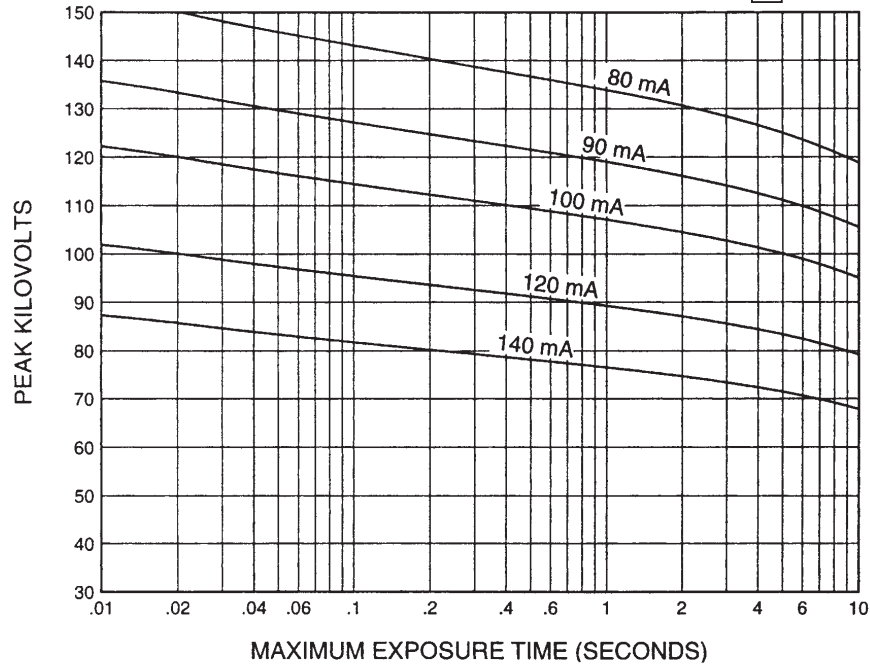

#### Nominal Focal Spot Size - 1.2

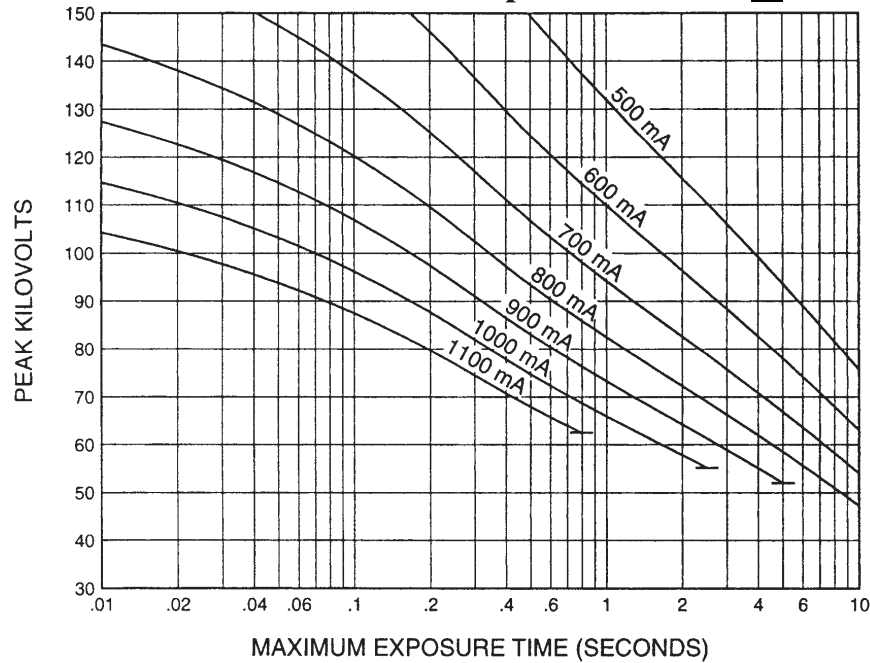

Nominal anode input power for the anode heat content 40%. IEC 60613

Puissance calorifique nominale de l'anode: 40%, CEI 60613

Thermische Anodenbezugsleistung bei einer Wärmespeicherung von 40%. IEC 60613

Aproximadamente el poder de penetracion para obtener un almacenaje de calor del anodo de 40%. IEC 60613

### 3 Ø Constant Potential

180 Hz

Abaques de Charge pour Pose Unique CEI 60613  
Brennfleck - Belastungskurven IEC 60613  
Diagramas de Exposición Radiográfica IEC 60613

#### Nominal Focal Spot Size - 0.3

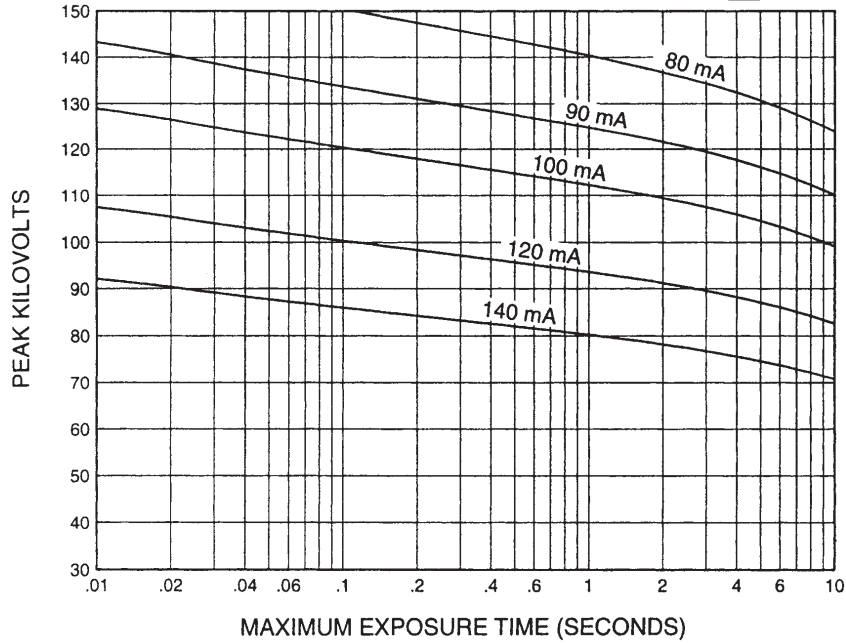

#### Nominal Focal Spot Size - 1.2

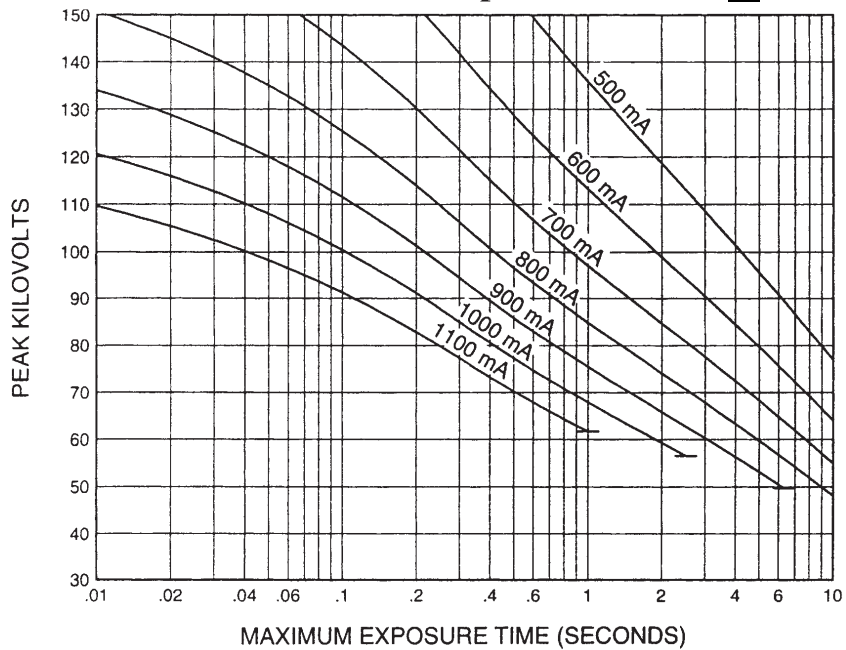

Nominal anode input power for the anode heat content 40%. IEC 60613

Puissance calorifique nominale de l'anode: 40%, CEI 60613

Thermische Anodenbezugsleistung bei einer Wärmespeicherung von 40%. IEC 60613

Aproximadamente el poder de penetracion para obtener un almacenaje de calor del anodo de 40%. IEC 60613



## CINERADIOGRAPHIC RATINGS

### HOW TO USE CINERADIOGRAPHIC CHARTS

**General:** With the Cineradiographic rating chart we can determine the maximum allowable kW of the Cine pulse, or with a given kW determine maximum time in seconds the Cine run can progress.

The Most common way of using the charts is to determine maximum time of any expected Cine run and maximum duty factor. With a known duty factor and cine run time the kW can easily be determined.

#### Definition of Terms

**Time in seconds:** Total time of one Cine run, usually 5 to 12 seconds.

**Duty Factor in Percent (DF%):** Actual time during one second the x-ray tube is producing x-rays. If we select a 4 msec pulse width and 60 exposures per second the x-ray tube will be producing x-rays for a total of 240 msec each second or 24% of the time. The higher the DF number, the more load placed on the x-ray tube.

**Peak Pulse Power:** Peak energy in watts of any one Cine Pulse. Can be any combination of kV and mA allowed by Radiographic and Filament Emission curves.

Example: 80 kV at 400 mA equals

$$80,000 \text{ V} \times 0.4 \text{ A} = 32,000 \text{ W or } 32 \text{ kW}$$

#### USING THE CINE RATING CHARTS:

G-1087 150/180 Hz 3 Phase 1.2 Focal Spot

**Example:** Determine maximum kW allowed with the following known factors:

Maximum Pulse Width ..... 4 msec

Exposures per Second ..... 60

Maximum Cine Run Time ... 10 seconds

**Calculate Duty Factor:** (DF%)

$$\text{DF\%} = \frac{\text{Pulse Width (msec)} \times \text{Frames per Second}}{10}$$

$$\text{DF\%} = \frac{4 \text{ msec} \times 60 \text{ exp/sec}}{10} = \frac{240}{10} = 24\%$$

Refer to Rating Chart G-1087 150/180 Hz 3 Phase 1.2 Focal Spot:

At bottom of chart find 10 second line. Move vertically to intersection with 24% DF curve. Make a horizontal reference to left side of rating chart and note kW rating of 60 kW.

kW = kV x mA. The kW of the exposure can be any combination of mA and kV allowed by the Radiographic and Filament Emission Charts.

The Cine rating charts are usable to 100% anode heat storage. Exceeding 100% anode heat storage will cause anode track erosion with high risk of tube destruction.



# 3 Ø Constant Potential

Abaques d'Expositions CEI 60613  
Belastungskurven IEC 60613  
Diagramas de Exposición IEC 60613

## 50/60 Hz

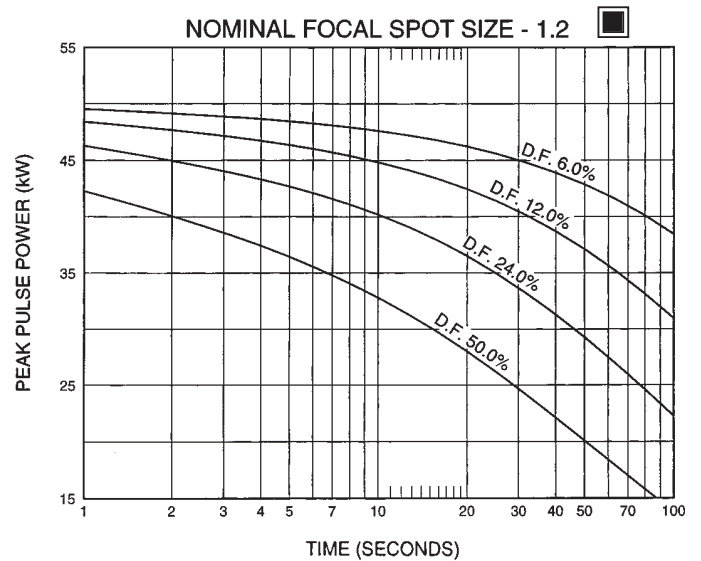
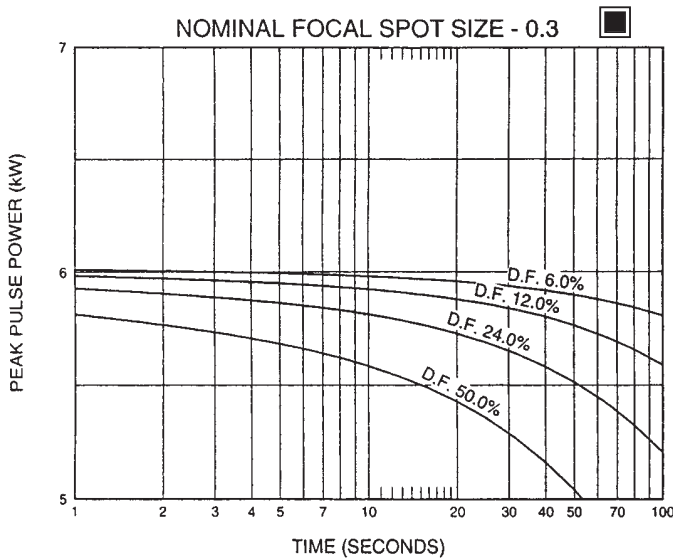

## 150/180 Hz

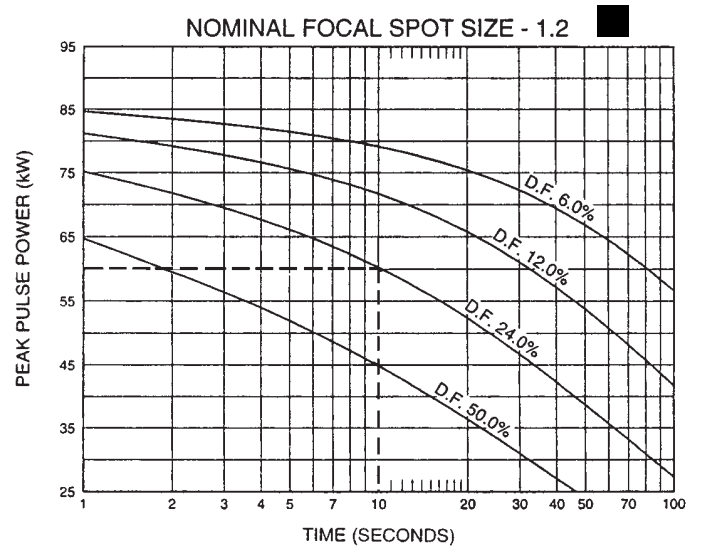
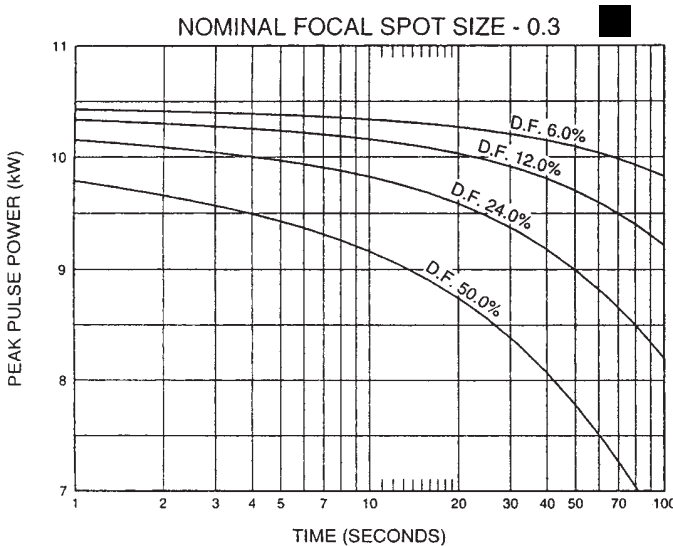

Nominal anode input power for the anode heat content 70%. IEC 60613

Puissance calorifique nominale de l'anode: 70%, CEI 60613

Thermische Anodenbezugsleistung bei einer Wärmespeicherung von 70%. IEC 60613

Aproximadamente el poder de penetracion para obtener un almacenaje de calor del anodo de 70%. IEC 60613

## ANGIOGRAPHIC RATINGS

### HOW TO USE ANGIOGRAPHIC CHARTS

**General:** Serial Radiography puts a severe demand on the x-ray tube due to the large number of exposures made in rapid succession. Intervals between exposures are fixed and so short that it is not possible for the anode track to cool to any extent during the exposure series. Therefore, the temperature of the anode track increases from exposure to exposure. The kW values used in the angiographic charts have been determined to prevent damage to the anode. The angiographic rating charts are usable to 100% anode heat storage. Exceeding 100% anode heat storage will cause anode track erosion with high risk of tube destruction.

#### Definition of Terms

**Number of Exposures in Series:** The number of exposures made in succession or the number of exposures made during one contrast injection.

**Exposure Rate:** The number of exposures made per second. For a series of exposures where the exposure rate changes, it must be assumed that all exposures will be made at the maximum rate. For example, if during a series 10 exposures will occur at one per second and 30 exposures at 4 per second use the kW ratings in the 40 exposure column at 4 per second rate.

**Exposure Time:** Time in seconds of each exposure.

#### USING THE CHARTS:

##### Select Correct Chart:

3 phase generator  
50/60 or 150/180 Hz  
0.3 or 1.2 Focal Spot

**Note:** 150/180 Hz rotor speed recommended for all angiography.

**Determine the number of exposures in Series:** With cut film angiography the number of exposures are known, however in Digital Angiography the number of exposures commonly are not known. When determining the number of exposures, assume worst case or past history.

**Note:** Most angiographic x-ray tubes fail from underestimating the number of exposures made in a series.

**Determine kW of each exposure in Series:** Referring to chart —find block under “Number of Exposures in Series” that is greater than or equal to expected number of exposures in Series. On left side directly opposite this block under “Exposure Rate per Second” column, select maximum rate per second that will be used for the exposure series. At the intersection of exposure rate and exposure time in seconds, find maximum kW allowed for each exposure.

**kW = pkV x mA:** The kW of the exposure can be any combination of mA and pkV allowed by the Radiographic and Filament Emission charts.

For Example: 80 pkV and 500 mA = 40 kW

**Example:** From chart G-1087 150/180 Hz 3 Phase 1.2 Focal Spot, determine kW allowed with following known factors.  
Maximum number of exposures .....40  
Exposure time .050 second (50 milliseconds)  
Maximum Exposures per second .....4

From chart find 40 exposure block. On left side directly opposite this block under “Exposure Rate per Second” column, select 4 exposures per second. Find .050 seconds at top of chart. At intersection of exposure rate line and exposure time, find 61.7 kW.

0.3 Focal Spot 3Ø 12 Degrees 50/60 Hz  
0.3 Dimension Focale 3Ø 12 Degrés 50/60 Hz  
0.3 Brennpunkt 3Ø 12 Grad 50/60 Hz  
0.3 De Marcas Focales 3Ø 12 Grados 50/60 Hz

Caractéristiques Pour L'Angiographie CEI 60613  
Angiographische Nennleistungen IEC 60613  
Gradaciones Angiografica IEC 60613

EXPOSURE RATE PER SECOND	TUBE LOAD (kW) AS A FUNCTION OF THE EXPOSURE TIME (SEC.) OF THE INDIVIDUAL RADIOGRAPHS OF THE SERIES															NUMBER OF EXPOSURES IN SERIES
	0.010	0.020	0.030	0.040	0.050	0.060	0.080	0.100	0.120	0.140	0.160	0.180	0.200	0.225	0.250	
1	6.0	6.0	6.0	5.9	5.9	5.9	5.8	5.8	5.8	5.7	5.7	5.7	5.7	5.6	5.6	10
2	6.0	6.0	6.0	5.9	5.9	5.9	5.8	5.8	5.8	5.7	5.7	5.7	5.6	5.6	5.6	
3	6.0	6.0	5.9	5.9	5.9	5.8	5.8	5.7	5.7	5.7	5.6	5.6				
4	6.0	6.0	5.9	5.9	5.9	5.8	5.8	5.7	5.7	5.6						
8	6.0	6.0	5.9	5.9	5.8	5.8										
15	6.0	6.0	5.9	5.8												
30	6.0	5.9														
1	6.0	6.0	6.0	5.9	5.9	5.8	5.8	5.8	5.7	5.7	5.7	5.6	5.6	5.6	5.5	20
2	6.0	6.0	5.9	5.9	5.9	5.8	5.8	5.7	5.7	5.6	5.6	5.6	5.6	5.5	5.5	
3	6.0	6.0	5.9	5.9	5.8	5.8	5.7	5.7	5.6	5.6	5.6	5.5	5.5			
4	6.0	6.0	5.9	5.9	5.8	5.8	5.7	5.7	5.6	5.6						
8	6.0	6.0	5.9	5.8	5.8	5.7										
15	6.0	5.9	5.8	5.7												
30	5.9	5.8														
1	6.0	6.0	5.9	5.9	5.8	5.8	5.7	5.7	5.6	5.6	5.6	5.5	5.5	5.4	5.4	40
2	6.0	6.0	5.9	5.9	5.8	5.8	5.7	5.7	5.6	5.6	5.5	5.5	5.4	5.4	5.3	
3	6.0	6.0	5.9	5.8	5.8	5.8	5.7	5.6	5.6	5.5	5.5	5.4	5.4	5.3	5.3	
4	6.0	6.0	5.9	5.8	5.8	5.7	5.7	5.6	5.5	5.5						
8	6.0	6.0	5.9	5.8	5.7	5.7										
15	6.0	5.9	5.8	5.7												
30	5.9	5.8														
1	6.0	6.0	5.9	5.9	5.8	5.8	5.7	5.6	5.6	5.5	5.4	5.4	5.3	5.3	5.2	60
2	6.0	6.0	5.9	5.8	5.8	5.7	5.7	5.6	5.5	5.5	5.4	5.4	5.3	5.3	5.2	
3	6.0	6.0	5.9	5.8	5.8	5.7	5.6	5.6	5.5	5.4	5.4	5.3	5.3	5.2		
4	6.0	6.0	5.9	5.8	5.7	5.7	5.6	5.5	5.4	5.4						
8	6.0	5.9	5.8	5.7	5.7	5.6										
15	6.0	5.9	5.7	5.6												
30	5.9	5.8														
1	6.0	6.0	5.9	5.8	5.8	5.7	5.6	5.6	5.5	5.4	5.4	5.3	5.3	5.2	5.1	80
2	6.0	6.0	5.9	5.8	5.8	5.7	5.6	5.5	5.5	5.4	5.3	5.3	5.2	5.1	5.1	
3	6.0	6.0	5.9	5.8	5.7	5.7	5.6	5.5	5.4	5.3	5.3	5.2				
4	6.0	6.0	5.9	5.8	5.7	5.7	5.6	5.5	5.4	5.3	5.3					
8	6.0	5.9	5.8	5.7	5.6	5.6										
15	5.9	5.9	5.7	5.6												
30	5.9	5.7														
1	6.0	6.0	5.9	5.8	5.7	5.7	5.6	5.5	5.4	5.4	5.3	5.2	5.2	5.1	5.0	100
2	6.0	6.0	5.9	5.8	5.7	5.7	5.6	5.5	5.4	5.3	5.2	5.2	5.1	5.0	5.0	
3	6.0	5.9	5.8	5.8	5.7	5.6	5.5	5.4	5.4	5.3	5.2	5.1				
4	6.0	5.9	5.8	5.8	5.7	5.6	5.5	5.4	5.3	5.2						
8	6.0	5.9	5.8	5.7	5.6	5.5										
15	5.9	5.8	5.7	5.6												
30	5.9	5.7														
1	6.0	5.9	5.8	5.7	5.7	5.6	5.5	5.4	5.3	5.2	5.1	5.1	5.0	5.0	4.9	150
2	6.0	5.9	5.8	5.7	5.7	5.6	5.5	5.3	5.2	5.1	5.1	5.0	4.9	4.8	4.8	
3	6.0	5.9	5.8	5.7	5.6	5.6	5.4	5.3	5.2	5.1	5.0	4.9				
4	6.0	5.9	5.8	5.7	5.6	5.5	5.4	5.3	5.2	5.0						
8	6.0	5.9	5.7	5.6	5.5	5.4										
15	5.9	5.8	5.6	5.5												
30	5.8	5.7														

**Note:**  
1. (kW) of Exposure Equals mA x kV. For Example: 70 kV x 300 mA = 21 kW.  
2. Exposures less than .010 seconds will have a kW rating same as .010 seconds.

**Remarque:**  
1. (kW) en exposition égale kV x mA. Par exemple: 70 kV x 300 mA = 21 kW.  
2. Les expositions inférieures à 0.010 sec. ont les mêmes valeurs en kW que celles de 0.010 sec.

**Anmerkungen:**  
1. (kW) der Belichtung is gleich mA x kV. Zum Beispiel: 70 kV x 300 mA = 21 kW.  
2. Belichtungen von weniger als .010 Sekunden haben die gleichen kW Werte wie die von .010 Sekunden.

**Nota:**  
1. (kW) De exposición se calcula multiplicando mA x kV-porejemplo: 70 kV x 300 mA = 21 kW.  
2. Para Exposiciones de Menos de .010 segundos, el resultado en (kW) seria lo mismo que el de .010 segundos.

Nominal anode input power for the anode heat content 70%. IEC 60613

Puissance calorifique nominale de l'anode: 70%, CEI 60613

Thermische Anodenbezugsleistung bei einer Wärmespeicherung von 70%. IEC 60613

Aproximadamente el poder de penetracion para obtener un almacenaje de calor del anode de 70%. IEC 60613

0.3 Focal Spot 3Ø 12 Degrees 150/180 Hz  
0.3 Dimension Focale 3Ø 12 Degrés 150/180 Hz  
0.3 Brennpunkt 3Ø 12 Grad 150/180 Hz  
0.3 De Marcas Focales 3Ø 12 Grados 150/180 Hz

Caractéristiques Pour L'Angiographie CEI 60613  
Angiographische Nennleistungen IEC 60613  
Gradaciones Angiografica IEC 60613

EXPOSURE RATE PER SECOND	TUBE LOAD (kW) AS A FUNCTION OF THE EXPOSURE TIME (SEC.) OF THE INDIVIDUAL RADIOGRAPHS OF THE SERIES															NUMBER OF EXPOSURES IN SERIES
	0.010	0.020	0.030	0.040	0.050	0.060	0.080	0.100	0.120	0.140	0.160	0.180	0.200	0.225	0.250	
1	10.4	10.2	10.1	10.0	9.9	9.8	9.7	9.6	9.6	9.5	9.4	9.4	9.3	9.3	9.2	10
2	10.4	10.2	10.1	9.9	9.9	9.8	9.7	9.6	9.5	9.4	9.3	9.3	9.2	9.1	9.1	
3	10.4	10.2	10.0	9.9	9.8	9.7	9.6	9.5	9.4	9.3	9.2	9.2				
4	10.4	10.2	10.0	9.9	9.8	9.7	9.6	9.4	9.3	9.3						
8	10.4	10.1	9.9	9.8	9.7	9.6										
30	10.3	10.0	9.8	9.6												
1	10.4	10.2	10.0	9.9	9.8	9.8	9.6	9.5	9.4	9.4	9.3	9.2	9.1	9.1	9.0	20
2	10.4	10.2	10.0	9.9	9.8	9.7	9.6	9.5	9.3	9.3	9.2	9.1	9.0	8.9	8.8	
3	10.4	10.2	10.0	9.9	9.8	9.7	9.5	9.4	9.3	9.2	9.1	9.0				
4	10.4	10.1	10.0	9.8	9.7	9.6	9.4	9.3	9.2	9.1						
8	10.3	10.1	9.9	9.7	9.6	9.4										
30	10.3	9.9	9.7	9.5												
1	10.4	10.2	10.0	9.9	9.7	9.7	9.5	9.4	9.2	9.1	9.0	8.9	8.8	8.7	8.6	40
2	10.4	10.1	10.0	9.8	9.7	9.6	9.4	9.3	9.1	9.0	8.9	8.8	8.7	8.6	8.4	
3	10.4	10.1	9.9	9.8	9.6	9.5	9.3	9.2	9.0	8.9	8.8	8.6				
4	10.4	10.1	9.9	9.7	9.6	9.5	9.3	9.1	8.9	8.8						
8	10.3	10.0	9.8	9.6	9.4	9.3										
30	10.2	9.9	9.6	9.3												
1	10.4	10.1	9.9	9.8	9.7	9.6	9.4	9.2	9.1	8.9	8.8	8.7	8.6	8.4	8.3	60
2	10.4	10.1	9.9	9.7	9.6	9.5	9.3	9.1	8.9	8.8	8.7	8.5	8.4	8.2	8.1	
3	10.3	10.1	9.9	9.7	9.6	9.4	9.2	9.0	8.8	8.7	8.5	8.4				
4	10.3	10.0	9.8	9.6	9.5	9.4	9.1	8.9	8.7	8.6						
8	10.3	9.9	9.7	9.5	9.3	9.1										
30	10.2	9.8	9.5	9.2												
1	10.4	10.1	9.9	9.7	9.6	9.5	9.2	9.1	8.9	8.7	8.6	8.4	8.3	8.1	8.0	80
2	10.3	10.1	9.8	9.7	9.5	9.4	9.2	9.0	8.8	8.6	8.4	8.3	8.1	8.0	7.8	
3	10.3	10.0	9.8	9.6	9.5	9.3	9.1	8.9	8.7	8.5	8.3	8.1				
4	10.3	10.0	9.8	9.6	9.4	9.3	9.0	8.8	8.6	8.4						
8	10.3	9.9	9.6	9.4	9.2	9.0										
30	10.2	9.7	9.4	9.1												
1	10.3	10.0	9.8	9.6	9.5	9.4	9.1	8.9	8.7	8.5	8.4	8.2	8.1	7.9	7.7	100
2	10.3	10.0	9.8	9.6	9.4	9.3	9.0	8.8	8.6	8.4	8.2	8.1	7.9	7.7	7.5	
3	10.3	10.0	9.7	9.5	9.4	9.2	9.0	8.7	8.5	8.3	8.1	7.9				
4	10.3	10.0	9.7	9.5	9.3	9.2	8.9	8.6	8.4	8.2						
8	10.2	9.9	9.6	9.3	9.1	8.9										
30	10.1	9.7	9.3	9.0												
1	10.3	10.0	9.7	9.5	9.3	9.1	8.8	8.6	8.3	8.1	7.9	7.7	7.5	7.3	7.1	150
2	10.3	9.9	9.7	9.4	9.2	9.1	8.7	8.5	8.2	8.0	7.8	7.6	7.4	7.1	6.9	
3	10.3	9.9	9.6	9.4	9.2	9.0	8.7	8.4	8.1	7.9	7.6	7.4				
4	10.2	9.9	9.6	9.3	9.1	8.9	8.6	8.3	8.0	7.7						
8	10.2	9.8	9.4	9.1	8.9	8.7										
30	10.1	9.6	9.2	8.8												

**Note:**  
1. (kW) of Exposure Equals mA x kV. For Example: 70 kV x 300 mA = 21 kW.  
2. Exposures less than .010 seconds will have a kW rating same as .010 seconds.

**Remarque:**  
1. (kW) en exposition égale kV x mA. Par exemple: 70 kV x 300 mA = 21 kW.  
2. Les expositions inférieures à 0.010 sec. ont les mêmes valeurs en kW que celles de 0.010 sec.

**Anmerkungen:**  
1. (kW) der Belichtung ist gleich mA x kV. Zum Beispiel: 70 kV x 300 mA = 21 kW.  
2. Belichtungen von weniger als .010 Sekunden haben die gleichen kW Werte wie die von .010 Sekunden.

**Nota:**  
1. (kW) De exposición se calcula multiplicando mA x kV-porejemplo: 70 kV x 300 mA = 21 kW.  
2. Para Exposición de Menos de .010 segundos, el resultado en (kW) sería lo mismo que el de .010 segundos.

Nominal anode input power for the anode heat content 70%. IEC 60613

Puissance calorifique nominale de l'anode: 70%, CEI 60613

Thermische Anoden bezugsleistung für eine speicherung von 70%. IEC 60613

Aproximadamente el poder de penetración para obtener un almacenaje de calor del anode de 70%. IEC 60613

1.2 Focal Spot 3Ø 12 Degrees 50/60 Hz  
1.2 Dimension Focale 3) 12 Degrés 50/60 Hz  
1.2 Brennpunkt 3Ø 12 Grad 50/60 Hz  
1.2 De Marcas Focales 3Ø 12 Grados 50/60 Hz

Caractéristiques Pour L'Angiographie CEI 60613  
Angiographische Nennleistungen IEC 60613  
Gradaciones Angiografica IEC 60613

Exposure rate per second	Tube load (kW) as a function of the exposure time (seconds) of the individual radiographs of the series															Number of exposures in series
	0.010	0.020	0.030	0.040	0.050	0.060	0.080	0.100	0.120	0.140	0.160	0.180	0.200	0.225	0.250	
1	50.2	49.9	48.8	47.8	47.0	46.2	44.9	43.7	42.6	41.7	40.8	40.0	39.2	38.3	37.5	10
2	50.1	49.5	48.3	47.2	46.3	45.4	43.9	42.6	41.4	40.3	39.3	38.4	37.5	36.6	35.6	
3	49.9	49.2	47.9	46.7	45.6	44.7	43.0	41.5	40.2	39.1	38.0	37.0				
4	49.8	48.9	47.5	46.1	45.0	44.0	42.1	40.6	39.2	37.9						
8	49.3	48.0	46.2	44.5	43.1	41.8										
15	48.6	46.8	44.5	42.5												
30	47.7	45.1														
1	50.0	49.4	48.1	46.9	45.9	45.0	43.3	41.9	40.6	39.4	38.4	37.4	36.4	35.4	34.4	20
2	49.8	49.0	47.5	46.2	45.1	44.0	42.2	40.6	39.1	37.9	36.7	35.6	34.6	33.4	32.4	
3	49.6	48.6	47.0	45.6	44.3	43.1	41.1	39.4	37.8	36.5	35.2	34.1				
4	49.4	48.2	46.5	44.9	43.6	42.3	40.2	38.3	36.7	35.2						
8	48.7	47.0	44.8	42.9	41.2	39.7										
15	47.8	45.4	42.6	40.3												
30	46.4	42.9														
1	49.5	48.5	46.9	45.4	44.1	42.9	40.8	39.0	37.4	35.9	34.6	33.4	32.3	31.0	29.8	40
2	49.3	48.1	46.3	44.6	43.2	41.9	39.6	37.6	35.9	34.3	32.9	31.6	30.5	29.2	28.0	
3	49.1	47.6	45.6	43.9	42.3	40.9	38.5	36.4	34.5	32.9	31.5	30.2				
4	48.8	47.2	45.1	43.2	41.5	40.0	37.4	35.2	33.3	31.7						
8	48.1	45.8	43.1	40.8	38.9	37.1										
15	46.9	43.8	40.5	37.8												
30	45.1	40.6														
1	49.1	47.7	45.8	44.0	42.5	41.1	38.7	36.6	34.7	33.1	31.6	30.3	29.0	27.4	24.7	60
2	48.9	47.3	45.1	43.2	41.6	40.1	37.4	35.2	33.3	31.6	30.1	28.7	27.5	26.1	24.7	
3	48.6	46.8	44.5	42.5	40.7	39.1	36.3	34.0	32.0	30.3	28.7	27.3				
4	48.4	46.3	43.9	41.7	39.8	38.2	35.3	32.9	30.9	29.1						
8	47.5	44.8	41.9	39.3	37.1	35.2										
15	46.3	42.6	39.1	36.1												
30	44.2	39.2														
1	48.7	47.0	44.8	42.8	41.0	39.5	36.7	34.4	32.4	30.7	28.9	25.7	23.1	20.6	18.5	80
2	48.5	46.5	44.1	42.0	40.1	38.4	35.6	33.2	31.1	29.3	27.7	25.7	23.1	20.6	18.5	
3	48.2	46.0	43.4	41.2	39.2	37.5	34.5	32.0	29.9	28.1	26.5	25.1				
4	47.9	45.5	42.8	40.4	38.4	36.6	33.5	31.0	28.8	27.0						
8	47.0	43.9	40.8	38.0	35.7	33.7										
15	45.7	41.7	37.9	34.8												
30	43.5	38.1														
1	48.3	46.3	43.8	41.6	39.7	38.0	35.0	32.6	30.5	26.4	23.1	20.6	18.5	16.4	14.8	100
2	48.1	45.8	43.1	40.8	38.8	37.0	33.9	31.4	29.2	26.4	23.1	20.6	18.5	16.4	14.8	
3	47.8	45.3	42.5	40.0	37.9	36.1	32.9	30.3	28.1	26.3	23.1	20.6				
4	47.5	44.8	41.8	39.3	37.1	35.2	32.0	29.3	27.1	25.3						
8	46.6	43.2	39.8	36.9	34.5	32.4										
15	45.2	40.9	36.9	33.7												
30	42.9	37.2														
1	47.4	44.6	41.5	38.9	36.7	34.7	30.8	24.7	20.6	17.6	15.4	13.7	12.3	11.0	9.9	150
2	47.1	44.0	40.9	38.1	35.8	33.8	30.4	24.7	20.6	17.6	15.4	13.7	12.3	11.0	9.9	
3	46.8	43.6	40.2	37.4	35.0	33.0	29.5	24.7	20.6	17.6	15.4	13.7				
4	46.5	43.1	39.6	36.7	34.3	32.2	28.7	24.7	20.6	17.6						
8	45.6	41.5	37.6	34.4	31.8	29.6										
15	44.1	39.1	34.8	31.4												
30	41.6	35.4														

**Note:**  
1. (kW) of Exposure Equals mA x kV.  
For Example: 70 kV x 300 mA = 21 kW.  
2. Exposures less than .010 seconds will have a kW rating same as .010 seconds.

**Remarque:**  
1. (kW) en exposition égale kV x mA.  
Par exemple: 70 kV x 300 mA = 21 kW.  
2. Les expositions inférieures à 0.010 sec. ont les mêmes valeurs en kW que celles de 0.010 sec.

**Anmerkungen:**  
1. (kW) der Belichtung ist gleich mA x kV.  
Zum Beispiel: 70 kV x 300 mA = 21 kW.  
2. Belichtungen von weniger als .010 Sekunden haben die gleichen kW Werte wie die von .010 Sekunden.

**Nota:**  
1. (kW) De exposición se calcula multiplicando mA x kV-porejemplo: 70 kV x 300 mA = 21 kW.  
2. Para Exposiciones de Menos de .010 segundos, el resultado en (kW) sería lo mismo que el de .010 segundos.

Nominal anode input power for the anode heat content 70%. IEC 60613

Puissance calorifique nominale de l'anode: 70%, CEI 60613

Thermische Anodenbezugsleistung bei einre Wärmespeicherung von 70%. IEC 60613

Aproximadamente el poder de penetracion para obtener un almacenaje de calor del anode de 70%. IEC 60613



1.2 Focal Spot 3Ø 12 Degrees 150/180 Hz  
1.2 Dimension Focale 3Ø 12 Degrés 150/180 Hz  
1.2 Brennpunkt 3Ø 12 Grad 150/180 Hz  
1.2 De Marcas Focales 3Ø 12 Grados 150/180 Hz

Caractéristiques Pour L'Angiographie CEI 60613  
Angiographische Nennleistungen IEC 60613  
Gradaciones Angiografica IEC 60613

Exposure rate per second	Tube load (kW) as a function of the exposure time (seconds) of the individual radiographs of the series															Number of exposures in series
	0.010	0.020	0.030	0.040	0.050	0.060	0.080	0.100	0.120	0.140	0.160	0.180	0.200	0.225	0.250	
1	85.7	81.8	79.0	76.6	74.5	72.7	69.5	66.8	64.4	62.3	60.4	58.6	57.0	55.1	53.4	10
2	85.3	81.0	77.8	75.1	72.8	70.8	67.2	64.2	61.6	59.2	57.1	55.2	53.5	51.5	49.7	
3	84.8	80.1	76.6	73.7	71.2	69.0	65.1	61.9	59.1	56.6	54.4	52.4	_____	_____	_____	
4	84.3	79.3	75.6	72.4	69.7	67.3	63.2	59.8	56.9	54.3	_____	_____	_____	_____	_____	
8	83.0	76.9	72.3	68.5	65.2	62.4	_____	_____	_____	_____	_____	_____	_____	_____	_____	
15	81.1	73.9	68.3	63.8	_____	_____	_____	_____	_____	_____	_____	_____	_____	_____	_____	
30	78.6	69.8	_____	_____	_____	_____	_____	_____	_____	_____	_____	_____	_____	_____	_____	
1	85.0	80.5	77.2	74.4	71.9	69.7	66.0	62.7	59.9	57.4	55.2	53.1	51.3	49.2	47.3	20
2	84.4	79.5	75.7	72.6	69.9	67.5	63.3	59.8	56.8	54.1	51.7	49.6	47.7	45.5	43.6	
3	83.8	78.5	74.4	71.0	68.0	65.4	61.0	57.2	54.1	51.3	48.8	46.7	_____	_____	_____	
4	83.3	77.5	73.1	69.4	66.3	63.5	58.8	55.0	51.7	48.9	_____	_____	_____	_____	_____	
8	81.5	74.5	69.1	64.7	61.0	57.8	_____	_____	_____	_____	_____	_____	_____	_____	_____	
15	79.0	70.4	64.0	58.9	_____	_____	_____	_____	_____	_____	_____	_____	_____	_____	_____	
30	75.2	64.6	_____	_____	_____	_____	_____	_____	_____	_____	_____	_____	_____	_____	_____	
1	83.8	78.3	74.1	70.6	67.6	64.9	60.3	56.4	53.1	50.2	47.7	45.4	43.4	41.1	37.0	40
2	83.1	77.1	72.5	68.7	65.5	62.6	57.6	53.6	50.1	47.2	44.6	42.3	40.2	38.0	36.0	
3	82.4	76.0	71.0	67.0	63.5	60.4	55.3	51.1	47.6	44.5	41.9	39.7	_____	_____	_____	
4	81.8	74.9	69.6	65.3	61.7	58.5	53.1	48.9	45.3	42.3	_____	_____	_____	_____	_____	
8	79.6	71.4	65.2	60.2	56.0	52.5	_____	_____	_____	_____	_____	_____	_____	_____	_____	
15	76.5	66.6	59.4	53.8	_____	_____	_____	_____	_____	_____	_____	_____	_____	_____	_____	
30	71.7	59.6	_____	_____	_____	_____	_____	_____	_____	_____	_____	_____	_____	_____	_____	
1	82.6	76.2	71.4	67.4	63.9	60.8	55.7	51.5	47.9	44.0	38.5	34.3	30.8	27.4	24.7	60
2	81.8	75.0	69.8	65.5	61.8	58.6	53.2	48.8	45.2	42.1	38.5	34.3	30.8	27.4	24.7	
3	81.1	73.8	68.3	63.7	59.9	56.5	51.0	46.5	42.9	39.8	37.2	34.3	_____	_____	_____	
4	80.4	72.7	66.8	62.1	58.1	54.6	49.0	44.5	40.9	37.8	_____	_____	_____	_____	_____	
8	78.1	69.0	62.3	56.9	52.5	48.8	_____	_____	_____	_____	_____	_____	_____	_____	_____	
15	74.8	64.0	56.3	50.5	_____	_____	_____	_____	_____	_____	_____	_____	_____	_____	_____	
30	69.5	56.6	_____	_____	_____	_____	_____	_____	_____	_____	_____	_____	_____	_____	_____	
1	81.4	74.3	68.9	64.4	60.6	57.3	51.8	46.2	38.5	33.0	28.9	25.7	23.1	20.6	18.5	80
2	80.7	73.1	67.3	62.6	58.6	55.2	49.5	45.0	38.5	33.0	28.9	25.7	23.1	20.6	18.5	
3	79.9	71.9	65.8	60.9	56.8	53.2	47.5	42.9	38.5	33.0	28.9	25.7	_____	_____	_____	
4	79.2	70.8	64.4	59.3	55.1	51.5	45.6	41.1	37.4	33.0	_____	_____	_____	_____	_____	
8	76.8	67.0	59.8	54.2	49.7	45.9	_____	_____	_____	_____	_____	_____	_____	_____	_____	
15	73.3	61.9	53.9	47.9	_____	_____	_____	_____	_____	_____	_____	_____	_____	_____	_____	
30	67.7	54.4	_____	_____	_____	_____	_____	_____	_____	_____	_____	_____	_____	_____	_____	
1	80.3	72.5	66.6	61.8	57.7	54.2	46.2	37.0	30.8	26.4	23.1	20.6	18.5	16.4	14.8	100
2	79.6	71.3	65.1	60.0	55.8	52.2	46.2	37.0	30.8	26.4	23.1	20.6	18.5	16.4	14.8	
3	78.8	70.1	63.6	58.4	54.1	50.4	44.5	37.0	30.8	26.4	23.1	20.6	_____	_____	_____	
4	78.1	69.0	62.2	56.8	52.4	48.7	42.8	37.0	30.8	26.4	_____	_____	_____	_____	_____	
8	75.6	65.2	57.7	51.9	47.3	43.5	_____	_____	_____	_____	_____	_____	_____	_____	_____	
15	72.1	60.1	51.9	45.8	_____	_____	_____	_____	_____	_____	_____	_____	_____	_____	_____	
30	66.3	52.5	_____	_____	_____	_____	_____	_____	_____	_____	_____	_____	_____	_____	_____	
1	77.8	68.4	61.5	56.1	49.3	41.1	30.8	24.7	20.6	17.6	15.4	13.7	12.3	11.0	9.9	150
2	77.0	67.2	60.1	54.5	49.3	41.1	30.8	24.7	20.6	17.6	15.4	13.7	12.3	11.0	9.9	
3	76.2	66.1	58.7	53.0	48.4	41.1	30.8	24.7	20.6	17.6	15.4	13.7	_____	_____	_____	
4	75.5	65.0	57.5	51.6	47.0	41.1	30.8	24.7	20.6	17.6	_____	_____	_____	_____	_____	
8	73.0	61.4	53.3	47.2	42.5	38.6	_____	_____	_____	_____	_____	_____	_____	_____	_____	
15	69.3	56.4	47.8	41.6	_____	_____	_____	_____	_____	_____	_____	_____	_____	_____	_____	
30	63.4	49.0	_____	_____	_____	_____	_____	_____	_____	_____	_____	_____	_____	_____	_____	

**Note:**  
1. (kW) of Exposure Equals mA x kV.  
For Example: 70 kV x 300 mA = 21 kW.  
2. Exposures less than .010 seconds will have a kW rating same as .010 seconds.

**Remarque:**  
1. (kW) en exposition égale kV x mA.  
Par exemple: 70 kV x 300 mA = 21 kW.  
2. Les expositions inférieures à 0.010 sec. ont les mêmes valeurs en kW que celles de 0.010 sec.

**Anmerkungen:**  
1. (kW) der Belichtung ist gleich mA x kV.  
Zum Beispiel: 70 kV x 300 mA = 21 kW.  
2. Belichtungen von weniger als .010 Sekunden haben die gleichen kW Werte wie die von .010 Sekunden.

**Nota:**  
1. (kW) De exposición se calcula multiplicando mA x kV-por ejemplo: 70 kV x 300 mA = 21 kW.  
2. Para Exposiciones de Menos de .010 segundos, el resultado en (kW) sería lo mismo que el de .010 segundos.

Nominal anode input power for the anode heat content 70%. IEC 60613

Puissance calorifique nominale de l'anode: 70%, CEI 60613

Thermische Anodenbezugsleistung bei einer Wärmespeicherung von 70%. IEC 60613

Aproximadamente el poder de penetración para obtener un almacenaje de calor del anode de 70%. IEC 60613

Abaques d'Échauffement et de Refroidissement de L'Anode  
Anoden Aufheiz - und Abkühlkurven  
Curvas de Calentamiento y Enfriamiento del Anodo

